



Equipped with AEM® Dryflow™ Filter
No Oil Required!

INSTALLATION INSTRUCTIONS

PART NUMBER:21-8113

2007-2009 FORD MUSTANG GT V-8 4.6L

**LEGAL IN CALIFORNIA ONLY FOR RACING VEHICLES
WHICH MAY NEVER BE USED, REGISTERED
OR LICENSED FOR USE UPON A HIGHWAY.**

See aemintakes.com for CARB status on each part for a specific vehicle

PARTS LIST

Description	Qty.	Part Number
A TB Spacer, Ford	1	2-9007
B O-ring, Size 2-145	2	1-3045
C Hose Clamp, 4.00-5.00"	1	103-BLO-7220N
D Nipple, Ford 04+, Weld On	1	2-693
E Hose, Adapter 3.50 To Oval EPDM	1	5-354
F 1/2" Bnd. Hose Clamp, 3.15"-4.00"	3	9456
G Upper Pipe, Mustang	1	2-81121
H Hose, Adapter 3.50/3.25x2.50	1	5-352
I 1/2" Bnd. Hose Clamp, 2.90"-3.75"	1	9452
J Mount, Rubber 1" X 8mm	1	1228560
K Bolt, Socket M4-0.7 X 10mm	2	1-2109
L Lower Pipe, Mustang GT	1	2-81122
M Heat Shield, Mustang GT	1	20-8113
N Bolt, Hex/Flange M6-1 X 20	2	1-2038
O Air Filter Assy. 3.25 X 9" Dry Ele.	1	21-2109D
P Washer, 8mm Soft Mount	4	559960
Q Nut, M8 Hex Serrated	2	444.460.08
R Nut, M6 Hex Serrated	1	444.460.04
S Bracket, Heat Shield	1	32-3038
T L-Key, T20	1	69801
U Zip Tie, 6 Long	2	1-113
V Rubber Edge Trim 20"	1	8-3020

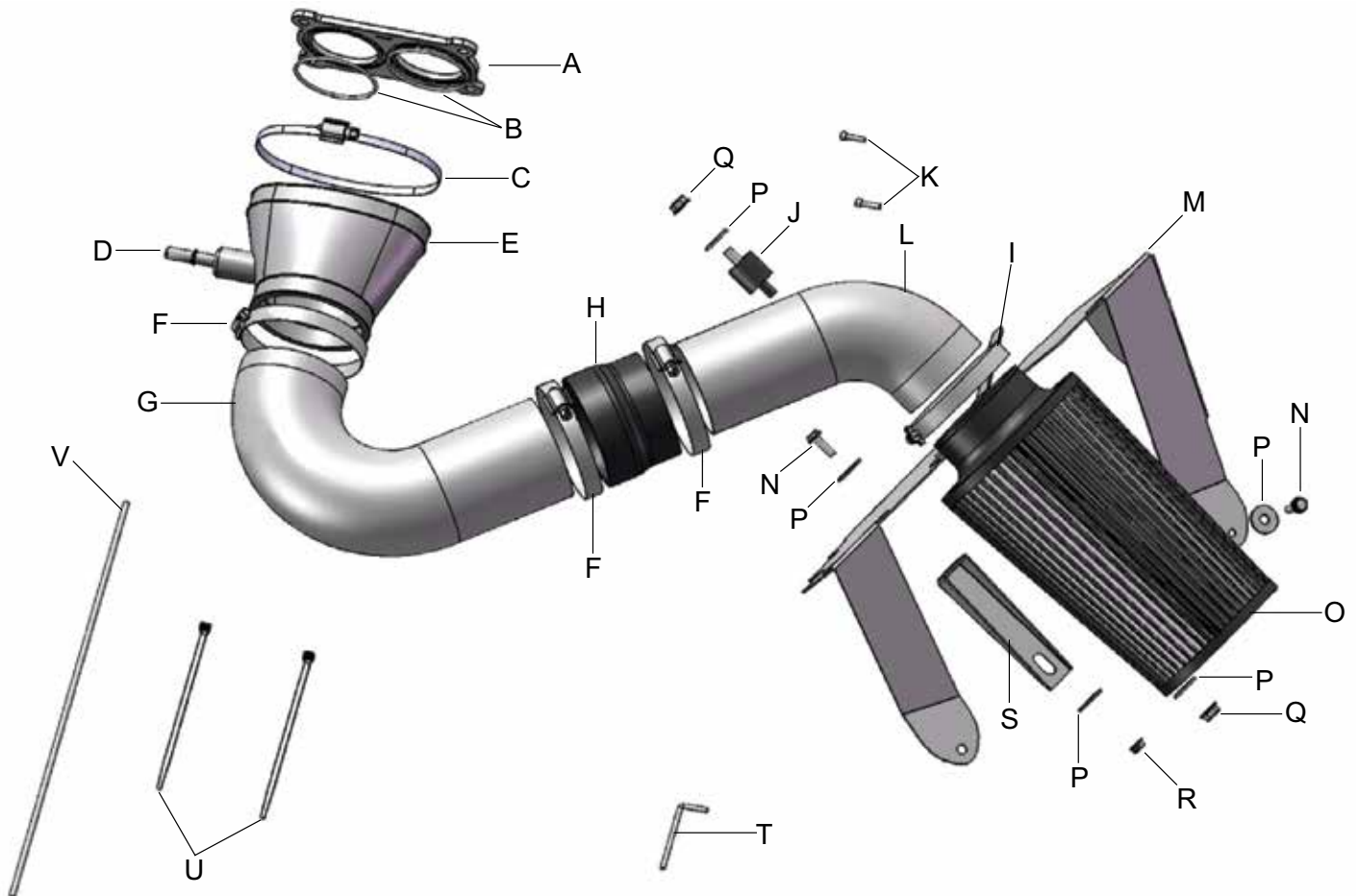

Read and understand these instructions **BEFORE** attempting to install this product. Failure to follow installation instructions and not using the provided hardware may damage the intake tube, throttle body and engine.

1. Preparing Vehicle

- a. Make sure vehicle is parked on level surface.
- b. Set parking brake.
- c. If engine has run in the past two hours, let it cool down.
- d. Disconnect negative battery terminal.
- e. Do not discard stock components after removal of the factory system.

2. Removal of stock system



a. Factory air box system configuration.



b. Disconnect the PCV hose connected to the inlet tube by pressing on the green retaining clip with your thumb. Then, pull the hose away from the plastic nipple.



c. With your finger, push the red locking mechanism on the electronic throttle control connector. This is located on the passenger side of the throttle body.

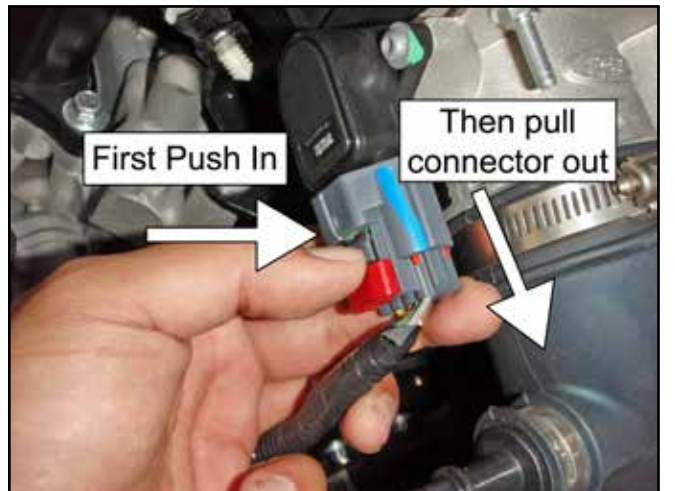

d. Push down on the button exposed once you have disabled the red locking mechanism. Then, pull the electronic throttle control connector toward the front of the vehicle.



e. The throttle position sensor is located on the driver side of the throttle body. Push the red locking mechanism on the throttle position connector out with your thumb.



f. Push down on the button exposed once you have disabled the red locking mechanism. Then, pull the throttle position connector away from the throttle body.



g. Push the red locking mechanism on the mass air flow sensor connector out with your thumb.



h. Push down on the button exposed once you have disabled the red locking mechanism. Then, pull the mass airflow sensor connector away from the mass air flow sensor.



i. Loosen the hose clamp securing the inlet tube to the throttle body



j. Loosen the hose clamp securing the inlet hose to the air box.



k. Remove the rubber inlet tube from the vehicle.



l. Remove the bolt securing the airbox to the driver side fender.

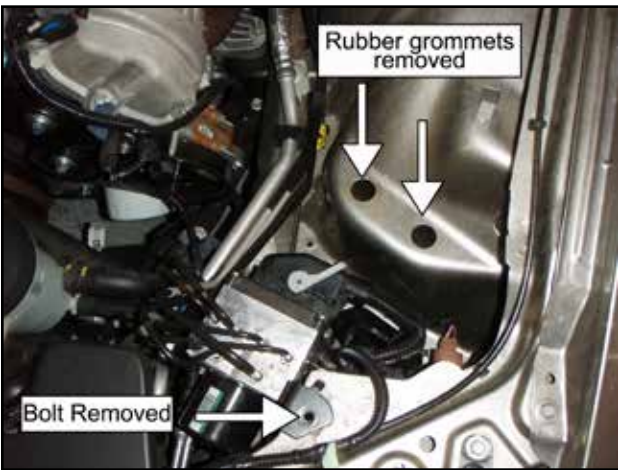

m. Pull the air box straight out of the vehicle. Then, remove the two rubber grommets located in the fender. Also, remove the bolt holding the upper support bracket for the ABS module.

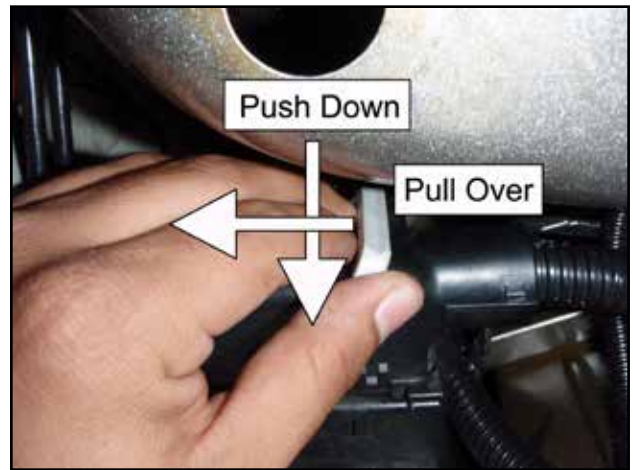

n. Unlock the ABS connector harness by pressing down on the button located on the connector and pulling the gray locking mechanism back.



o. To the left is a picture of the gray locking mechanism disengaged fully.



p. Pull the ABS connector harness away from the ABS module.



q. Remove the bolt that secures the ABS module bracket to the fender.

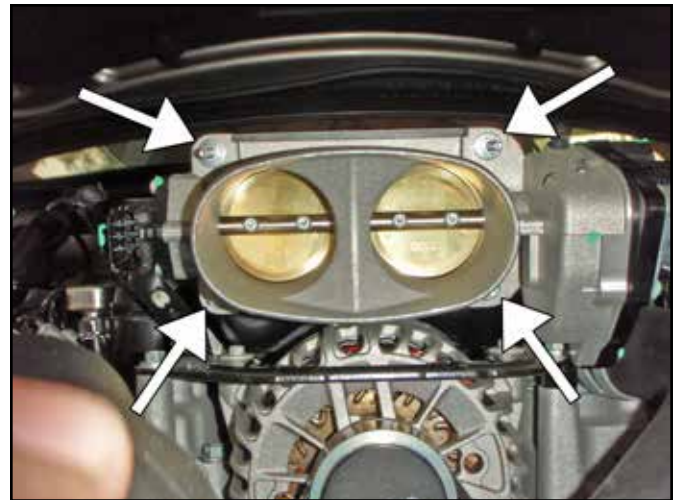

r. Remove the two bolts and 2 nuts securing the throttle body to the intake manifold. Then remove the throttle body.



s. Make sure once the throttle body is removed that the orange rubber gasket is still on the intake manifold.



t. Factory air box system removed.

3. Installation of AEM® intake system.

a. When installing the intake system, do not completely tighten the hose clamps or mounting hardware until instructed to do so.



b. Install the two supplied o-rings into the throttle body spacer. Dab a small amount of grease into the groove to hold the o-rings in place during assembly.



c. Place the throttle body spacer on the intake manifold studs.



d. Install the throttle body making sure that the orings and the orange rubber gasket seat correctly. Hand tighten the two bolts and two nuts removed in step 2r.



e. Torque the two nuts and the two bolts to 89 lbin (10 Nm). Do not over tighten.



f. Re-connect the throttle control connector. You will hear a clicking sound when it is fully engaged.



g. Lock the throttle control connector by pushing down the red locking mechanism. You will hear a click when this is fully engaged.



h. Re-connect the throttle position connector.
NOTE: Be sure to listen for a clicking sound to ensure the connector is locked into place completely.



i. Lock the throttle position connector by pushing down the red locking mechanism. You will hear a click when this is fully engaged.



j. Throttle body spacer fully installed and torqued to specifications.

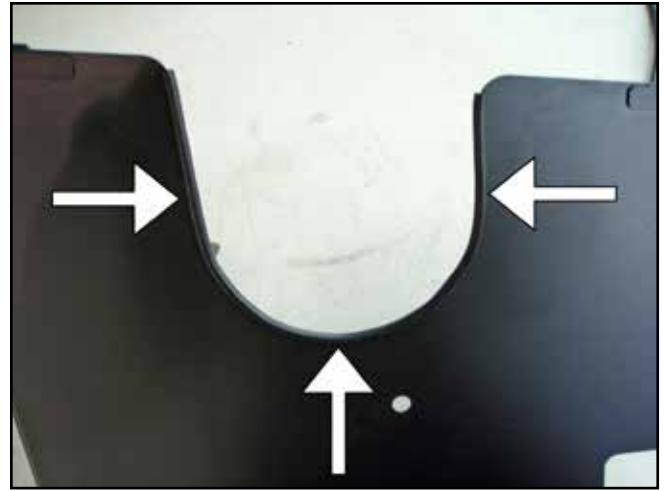

k. Install the supplied rubber edge trim around the "U" shaped opening on the heatshield.



l. Install the supplied plastic nipple into oval coupler.



m. Remove the mass air flow sensor from the stock housing, use the supplied torx tool. Immediately install the sensor in the lower AEM® intake pipe.



n. Secure the mass air flow sensor in the pipe with the two supplied M4 socket bolts.



o. Install the #72 hose clamp on the oval side of the coupler and then install the coupler onto the throttle body. Install the #56 coupler on the round side of the coupler. Keep all of the hose clamps loose.



p. Re-connect the PCV hose onto the nipple located on the oval coupler.



q. Install the heat shield into the engine compartment by carefully sliding it under the AC lines and aligning the two mounting arms with the holes in the fender and upper ABS mount. Secure using the previously removed bolt for the ABS housing and one supplied M6 bolt and washer.

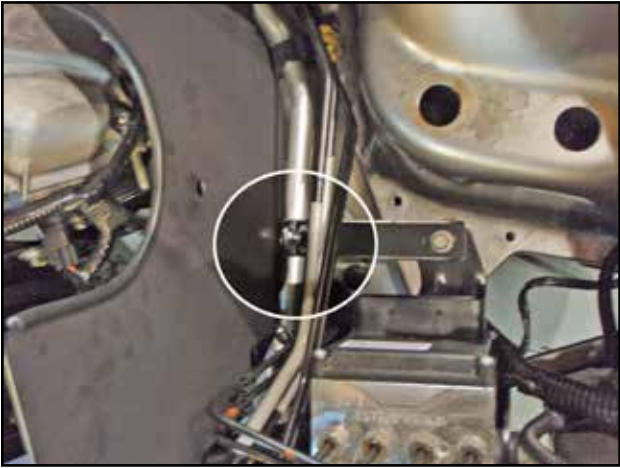

r. Install the lower heat shield mount by using the previously removed lower ABS mount bolt. Use the supplied M6 bolt, nut, and washers to secure the lower mount to the heat shield.



s. Install the rubber mount in the heatshield using the supplied washer and nut.



t. Plug the ABS harness back into the ABS module.



u. Lock the ABS harness into place using the gray locking mechanism.
NOTE: Listen for a click.



v. Install the upper intake pipe into round side of the oval coupler.



w. Install the supplied reducing coupler onto the upper intake pipe. Loosely secure with a #56 hose clamp.



x. Install the lower intake pipe into the reducing coupler with a #52 hose clamp and align the bracket with the rubber mount installed on the heatshield. Loosely secure the bracket with the supplied washer and nut.



y. Install the Dryflow™ air filter onto the end of the lower intake pipe, loosely secure with a #56 hose clamp.



z. Re-connect the mass airflow sensor wiring harness.



Aa. Lock the mass airflow sensor wiring harness.



Factory air box system installed



AEM® intake system installed

4. Reassemble Vehicle

- a. Position the inlet pipes for the best fitment. Be sure that the pipes or any other components do not contact any part of the vehicle. Tighten the rubber mount, all bolts, and hose clamps.
- b. Check for proper hood clearance. Re-adjust pipes if necessary and re-tighten them.
- c. Inspect the engine bay for any loose tools and check that all fasteners that were moved or removed are properly tightened.
- d. Reconnect negative battery terminals and start engine. Let the vehicle idle for 3 minutes. Perform a final inspection before driving the vehicle.

5. CARB Sticker Placement

- a. The C.A.R.B. exemption sticker, (attached), must be visible under the hood so that an emissions inspector can see it when the vehicle is required to be tested for emissions. California requires testing every two years, other states may vary.

6. Service and Maintenance

- a. It is recommended that you service your AEM® Dryflow™ filter every 20,000 miles for optimum performance. Use AEM Dryflow cleaning kit part # 21-110.
- b. Use aluminum polish to clean your polished AEM® intake tube.
- c. Use window cleaner to clean your powder coated AEM® intake tube. **(NOTE: DO NOT USE aluminum polish on powder coated AEM intake tubes).**

For technical inquiries
e-mail us at
sales@aemintakes.com
or
call us at
800.992.3000

AEM Air Intake System Warranty Policy

AEM® warrants that its intake systems will last for the life of your vehicle. AEM will not honor this warranty due to mechanical damage (i.e. improper installation or fitment), damage from misuse, accidents or flying debris. AEM will not warrant its powder coating if the finish has been cleaned with a hydrocarbon-based solvent. The powder coating should only be cleaned with a mild soap and water solution. Proof of purchase of both the vehicle and AEM intake system is required for redemption of a warranty claim.

This warranty is limited to the repair or replacement of the AEM part. In no event shall this warranty exceed the original purchase price of the AEM part nor shall AEM be responsible for special, incidental or consequential damages or cost incurred due to the failure of this product. Warranty claims to AEM must be transportation prepaid and accompanied with dated proof of purchase. This warranty applies only to the original purchaser of product and is nontransferable. Improper use or installation, use for racing, accident, abuse, unauthorized repairs or alterations voids this warranty. AEM disclaims any liability for consequential damages due to breach of any written or implied warranty on all products manufactured by AEM. Warranty returns will only be accepted by AEM when accompanied by a valid Return Merchandise Authorization (RMA) number. Credit for defective products will be issued pending inspection. Product must be received by AEM within 30 days of the date RMA is issued.

If you have a warranty issue, please call (800) 992-3000 and our customer service department will assist you. A proof of purchase is required for all AEM warranty claims.

**LEGAL IN CALIFORNIA ONLY FOR RACING VEHICLES
WHICH MAY NEVER BE USED, REGISTERED
OR LICENSED FOR USE UPON A HIGHWAY.**

See aemintakes.com for CARB status on each part for a specific vehicle