

**Air Lift**<sup>TM</sup>  
**PERFORMANCE**

**Kit 75577**  
**Audi A6**  
**C6 Platform**  
**front application**



## **INSTALLATION GUIDE**

For maximum effectiveness and safety, please read these instructions completely before proceeding with installation.

*Failure to read these instructions can result in an incorrect installation.*



# TABLE OF CONTENTS

<b>Introduction</b> .....	<b>2</b>
Notation Explanation .....	2
Important Safety Notices .....	2
<b>Installation Diagram</b> .....	<b>3</b>
Hardware List .....	3
Tools List .....	3
<b>Installing the Air Suspension</b> .....	<b>4</b>
Preparing the Vehicle .....	4
Stock Shock Removal .....	4
Modifications for Air Suspension .....	6
Installing the Air Suspension .....	8
Damping Adjustment .....	11
Aligning the Vehicle .....	12
<b>Before Operating</b> .....	<b>12</b>
Installation Checklist .....	13
Post-installation checklist .....	13
<b>Product Use, Maintenance and Servicing</b> .....	<b>14</b>
Suggested Driving Air Pressure and Maximum Air Pressure .....	14
Maintenance Guidelines .....	14
Troubleshooting Guide .....	14
Frequently Asked Questions .....	14
Tuning the Air Pressure .....	15
Checking for Leaks .....	15
Fixing Leaks .....	15
<b>Warranty and Returns Policy</b> .....	<b>16</b>
<b>Replacement Information</b> .....	<b>16</b>
<b>Contact Information</b> .....	<b>16</b>

# Introduction

The purpose of this publication is to assist with the installation, maintenance and troubleshooting of this Audi performance kit.

It is important to read and understand the entire installation guide before beginning installation or performing any maintenance, service or repair. The information includes a hardware list, tool list, step-by-step installation information, maintenance tips, safety information and a troubleshooting guide.

Air Lift Company reserves the right to make changes and improvements to its products and publications at any time. For the latest version of this manual, contact Air Lift Company at (800) 248-0892 or visit our website at [www.airliftcompany.com](http://www.airliftcompany.com).

## NOTATION EXPLANATION

Hazard notations appear in various locations in this publication. Information which is highlighted by one of these notations must be observed to help minimize risk of personal injury or possible improper installation which may render the vehicle unsafe. Notes are used to help emphasize areas of procedural importance and provide helpful suggestions. The following definitions explain the use of these notations as they appear throughout this guide.

 **DANGER**

INDICATES IMMEDIATE HAZARDS WHICH WILL RESULT IN SEVERE PERSONAL INJURY OR DEATH.

 **WARNING**

INDICATES HAZARDS OR UNSAFE PRACTICES WHICH COULD RESULT IN SEVERE PERSONAL INJURY OR DEATH.

 **CAUTION**

INDICATES HAZARDS OR UNSAFE PRACTICES WHICH COULD RESULT IN DAMAGE TO THE MACHINE OR MINOR PERSONAL INJURY.

---

**NOTE**

*Indicates a procedure, practice or hint which is important to highlight.*

---

## IMPORTANT SAFETY NOTICES

The installation of this kit does not alter the Gross Vehicle Weight Rating (GVWR) or payload of the vehicle. Check your vehicle's owner's manual and do not exceed the maximum load listed for your vehicle.

**Gross Vehicle Weight Rating:** The maximum allowable weight of the fully loaded vehicle (including passengers and cargo). This number — along with other weight limits, as well as tire, rim size and inflation pressure data — is shown on the vehicle's Safety Compliance Certification Label.

**Payload:** The combined, maximum allowable weight of cargo and passengers that the vehicle is designed to carry. Payload is GVWR minus the Base Curb Weight.

 **WARNING**

DO NOT INFLATE AIR SPRINGS WHILE OFF OF THE VEHICLE. DAMAGE TO ASSEMBLY MAY RESULT AND VOID WARRANTY.

 **CAUTION**

DO NOT WELD TO, OR MODIFY LIFESTYLE STRUTS/SOCKS IN ANY WAY. DAMAGE TO UNIT MAY OCCUR AND WILL VOID WARRANTY.

# Installation Diagram

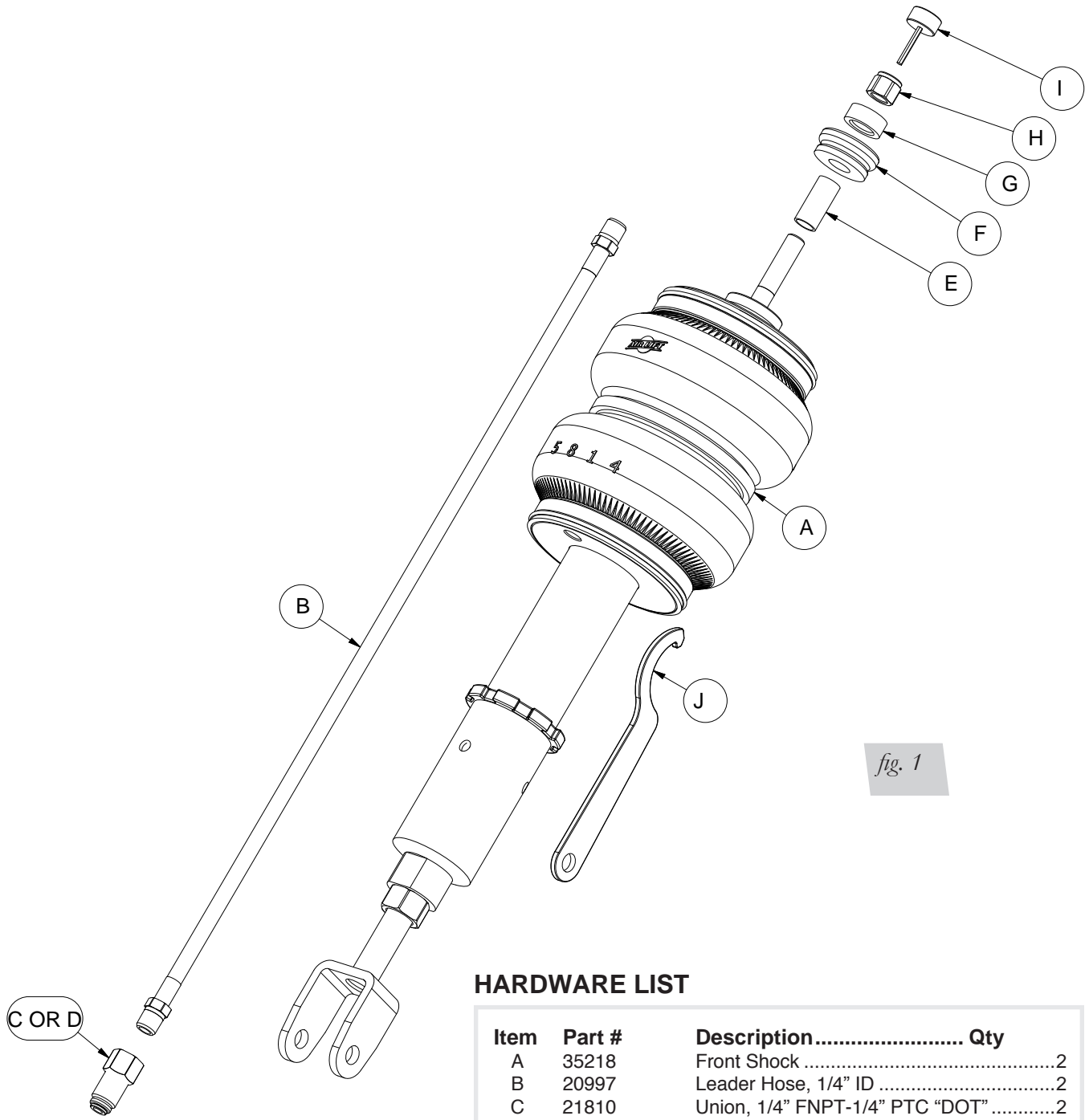

*fig. 1*

## HARDWARE LIST

Item	Part #	Description.....	Qty
A	35218	Front Shock .....	2
B	20997	Leader Hose, 1/4" ID .....	2
C	21810	Union, 1/4" FNPT-1/4" PTC "DOT" .....	2
D	21987	Union, 1/4" FNPT X 3/8" Fitting "DOT" .....	2
E	26966-007	Shock Rod Spacer.....	2
F	26966-006	Shock Isolator .....	2
G	26930-010	Shock Centering Spacer.....	2
H	26966-008	M12 X 1.25 Nyloc Nut.....	2
I	26966-009	Shock Adjuster.....	2
J	26966-011	Collar Wrench.....	1

**STOP!** Missing or damaged parts? Call Air Lift customer service at (800) 248-0892 for a replacement part.

# Installing the Air Suspension

## PREPARING THE VEHICLE

1. Support vehicle with jack stands or a hoist at approved lifting points.
2. Remove the front wheels

## STOCK SHOCK REMOVAL

### NOTE

*If equipped with headlight alignment system, **disconnect range control linkage first.***

1. Support the hub assembly to prevent over extension of suspension components
2. Remove lower shock bolt from track control link (bolt 1 in fig 2).
3. Disconnect the stabilizer bar (bolt 2 or 4 in fig 2).
4. Unbolt the track control link from the chassis (bolt 3 in figure 2).

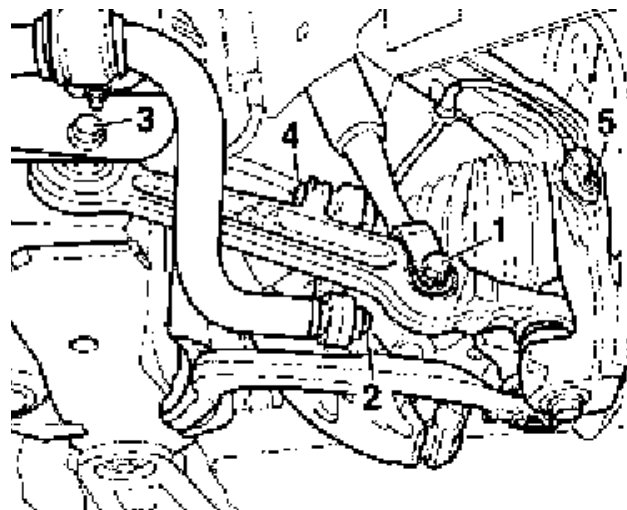

*fig. 2*

5. Remove the bolt from the upper control arms to adjoining steering knuckle (bolt 2 in fig 3). Remove the upper control arm ball joints from the steering knuckle.

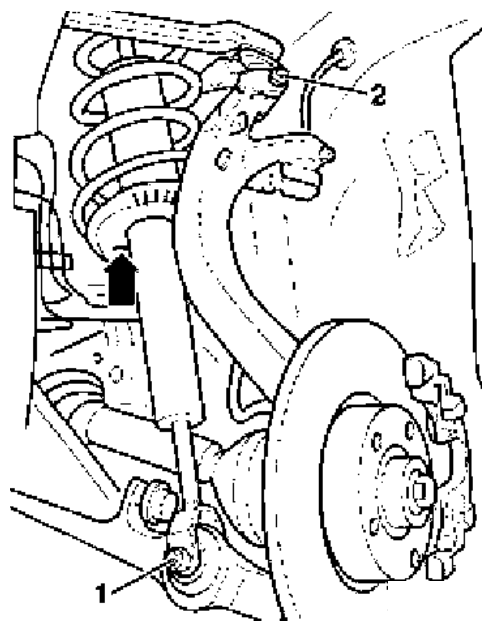

*fig. 3*

6. Unbolt the three bolts holding the stock upper bracket to the chassis (fig 4).



*fig. 4*

7. Remove the shock assembly from the vehicle.
8. Securely mount the shock assembly in a coil spring compressor, compress the spring and remove the nut from the top of the shock rod. Safely release the assembly. Retain the upper bracket and rubber isolator.
9. **If the upper control arm bolt heads face toward the outside of the bracket remove the bolts and flip them so the head of the bolt will face the air spring (fig 5). This is done to gain air spring clearance and prevent wear of the air spring. Failure to do this may result in a premature failure of the air spring and will not be covered under warranty. Tighten the bolts down just enough that the bushing can still rotate around the bolt.**

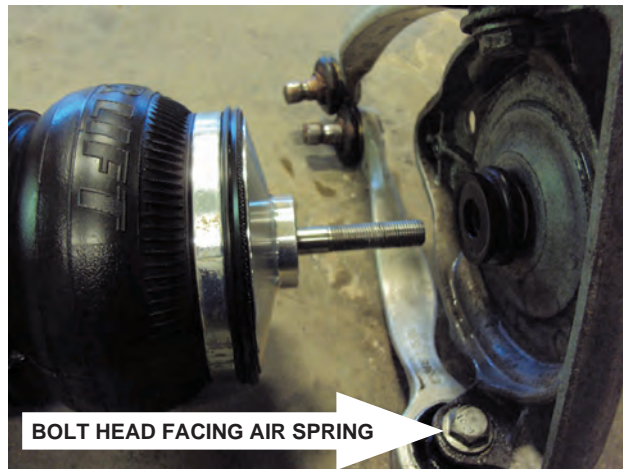
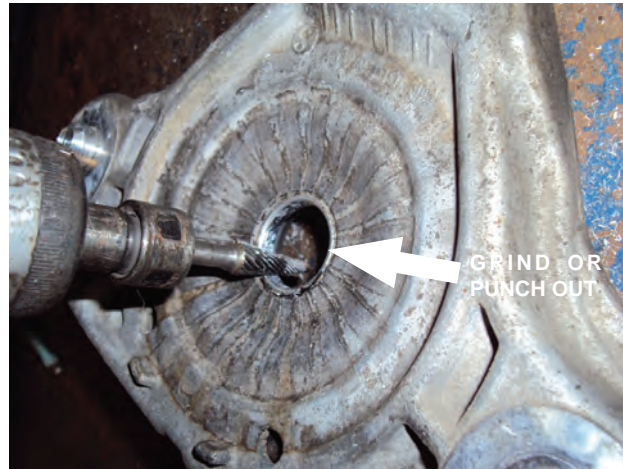

*fig. 5*



## MODIFICATIONS FOR AIR SUSPENSION

1. Remove the jounce bumper cup from the upper bracket (fig 6 and 7). Do not remove extra material from the upper bracket. Remove the plastic guide spacer from the new shock assembly and insert into the upper bracket hole (fig 8). This fitment should be a mild press fit (fig 9). Light grinding may be required to accomplish the desired fitment.

*fig. 6*

*fig. 7*

*fig. 8*





*fig. 9*

2. Center punch and drill a 3/8" hole through the center of the suspension shock dome. This hole will be used as an access port for damping adjustments (fig 10 and 11).



*fig. 10*



*fig. 11*

## INSTALLING THE AIR SUSPENSION

1. Begin by installing the leader line into the air spring. Wrap the threads of the leader hose with Teflon tape or thread sealant. Tighten the appropriate fitting to the airline 1 ¼ turns beyond hand tight. Tighten the leader line into the air spring 1 ¼ turns beyond hand tight (fig 12).

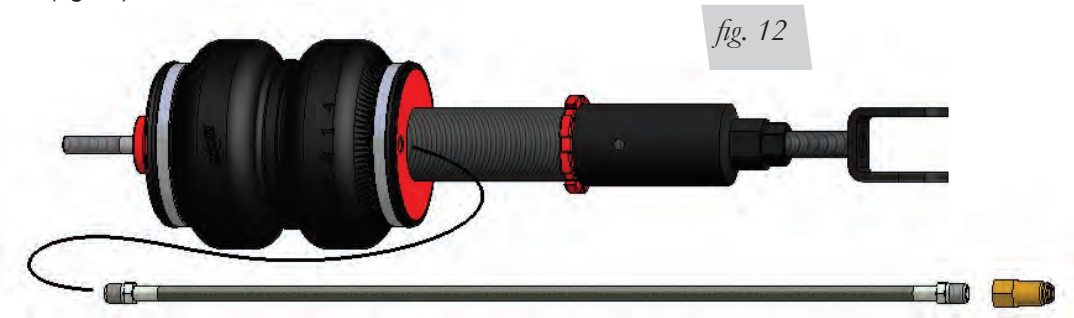

*fig. 12*

2. Apply the supplied rubber isolator from the shock with the large convolute slipping over the previously installed metal sleeve spacer to the bottom side of the upper bracket as shown (fig 13).



*fig. 13*

3. Insert shock rod through the upper bracket (fig 14). Apply the stock isolator over the rod and thread lock nut on top (fig 15 and 16). Rotate the shock assembly until the leader hose is toward the back of the bracket (fig 18). **Tighten the nut onto the rod using hand tools.** (fig 16 and 17) An impact wrench may not fully seat the nut before the rod starts to spin. **If the nut is not tight, there will be a rattle noise.** If an impact wrench is used, damage will occur to the shock. Tighten the nyloc nut on the shock rod to 27Nm (20 ft-lbs).



*fig. 14*



fig. 15



fig. 16



fig. 17



fig. 18



4. Insert the new assembly and attach the upper bracket in place with the three bolts previously removed (fig. 4). Make sure the shims are correctly seated to the chassis and not hung up on the upper bracket bosses.
5. Loosely install the clevis bolt into the lower control arm (figs. 2 and 3). Also, loosely reinstall the track link to chassis bolt (fig 2 and 3). Loosely reattach the sway bar (fig. 2). **Do not tighten these at this time.**
6. Reattach the upper control arm ball joints to the steering knuckle (fig. 3). Make sure the joints are fully seated as the bolt is slid through.
7. At this time, it is best practice to compress the suspension fully using a jack. With the suspension compressed, review the best routing for the leader hose that is clear of all suspension components and axle. Routing should also allow for the suspension to extend without kinking the line or rubbing on other components. Also check other clearances to all components especially the steering knuckle to any wires while at full drop.
8. With the suspension fully compressed, take a measurement from the fender to some reference point, typically the center of the axle. Record this as Max Compression (MC). Cycle the suspension to Max Extension (ME) and record the measurement from the same reference points. Take the difference between the two numbers and divide by two. Add that value to the Max Compression number and then set the suspension to that point (fig. 19). This position gives 50% stroke in either direction and is a great starting point for ride height. At this position torque the lower clevis bolt, upper and lower control arm bolts to manufacturer's specifications (Table 1).

Formula for calculating ride height:

$$\begin{array}{l}
 \text{Step 1:} \\
 \frac{\text{ME} - \text{MC}}{X} \\
 \\
 \text{Step 3:} \\
 \frac{Y + \text{MC}}{Z}
 \end{array}
 \qquad
 \begin{array}{l}
 \text{Step 2:} \\
 \frac{X}{2} = Y \\
 \\
 \text{Answer:} \\
 Z = \text{DESIGN HEIGHT}
 \end{array}
 \qquad
 \text{fig. 19}$$

9. Reinstall wheels; retake the Max Compression and Extension measurements from the fender to lower wheel lip. Recalculate the ride height at 50% stroke and set the vehicle to that height. Enjoy the new look and handling! Now go get an alignment at the preferred drive height.

Torque Specifications		
Location	Nm	ft. lbs.
Shock Rod Nut	50	37
Upper bracket to chassis	50Nm + 90°	37 ft./lbs. + 90°
Upper control arms to bracket	50Nm + 90°	37 ft./lbs. + 90°
Upper control arms to steering knuckle	45	30
Lower control arm to shock clevis	90	66
Lower control arm to subframe	70Nm + 180°	52 ft./lbs. + 180°
Guide link to subframe	70Nm + 180°	52 ft./lbs. + 180°
End link to track control link	40Nm + 90°	30 ft./lbs. + 90°
End link to sway bar	40Nm + 90°	30 ft./lbs. + 90°
Wheels	120	89

Table 1

## DAMPING ADJUSTMENT

The shocks in this kit have 30 settings or “clicks” of adjustable compression and rebound damping characteristics. Damping is changed through the shock rod using the supplied adjuster or a 3mm Allen wrench. Turn the adjuster clockwise and the damping settings are hardened. Turn the adjuster counterclockwise and the damping is softened. Each front shock is preset to “-12 clicks”. This means that the shock is adjusted 12 clicks away from full stiff. Counting down from full stiff is the preferred method of keeping track/setting of damping. This setting was developed on a 2007 A6 4.2L V8 Quattro and may need to be adjusted to the different vehicles and driving characteristics.



*fig. 20*



*fig. 21*

## ALIGNING THE VEHICLE

1. Using the control system, set the vehicle height to the new custom ride height.
2. If the custom ride height is lower than stock, we recommend loosening all pivot points (bolts, nuts) on any control arm, strut arm or radius rod that contains bushings (fig. 3). Once they have been loosened, re-torque to stock specifications (Table 1).

---

**NOTE**

*It may be necessary to cycle the suspension to loosen the bushing up from its mount. This will help re-orient the bushing at its new position based on the custom ride height.*

---

## Before Operating

**CAUTION**

MAKE SURE THE FRONT WHEELS ARE STRAIGHT WHEN DEFLATING AND REINFLATING AIR BAGS.

1. Inflate and deflate the system (do not exceed 125 PSI) to check for clearance or binding issues. With the air springs deflated, check clearances on everything so as not to pinch brake lines, vent tubes, etc. Clear lines if necessary.
2. Inflate the air springs to 75PSI - 90PSI and check all connections for leaks.
3. Air Lift part #27669 or #27671, AutoPilot V2 Air Management System, is highly recommended for this product.
4. Please continue by reading the Product Use, Maintenance and Servicing section.



## INSTALLATION CHECKLIST

- Clearance test — Inflate the air springs to 75-90 PSI and make sure there is at least ½” clearance from anything that might rub against each sleeve. Be sure to check the tire, brake drum, frame, shock absorbers and brake cables.
  
- Leak test before road test — Inflate the air springs to 75PSI - 90PSI and check all connections for leaks. All leaks must be eliminated before the vehicle is road tested.
  
- Heat test — Be sure there is sufficient clearance from heat sources, at least 6” for air springs and air lines. If a heat shield was included in the kit, install it. If there is no heat shield, but one is required, call Air Lift customer service at (800) 248-0892.
  
- Fastener test — Recheck all bolts for proper torque.
  
- Road test — The vehicle should be road tested after the preceding tests. Inflate the springs to recommended driving pressures. Drive the vehicle 10 miles and recheck for clearance, loose fasteners and air leaks.
  
- Operating instructions — If professionally installed, the installer should review the operating instructions with the owner. Be sure to provide the owner with all of the paperwork that came with the kit.

**Technician's Signature** \_\_\_\_\_

**Date** \_\_\_\_\_

## POST-INSTALLATION CHECKLIST

- Overnight leak down test — Recheck air pressure after the vehicle has been used for 24 hours. If the pressure has dropped more than 5 PSI, then there is a leak that must be fixed. Either fix the leak yourself or return to the installer for service.
  
- Air pressure requirements — I understand the air pressure requirements of my air spring system. Regardless of load, the air pressure should always be adjusted to maintain adequate ride height at all times while driving.
  
- Thirty day or 500 mile test — I understand that I must recheck the air spring system after 30 days or 500 miles, whichever comes first. If any part shows signs of rubbing or abrasion, the source should be identified and moved, if possible. If it is not possible to relocate the cause of the abrasion, the air spring may need to be remounted. If professionally installed, the installer should be consulted. Check all fasteners for tightness.

# Product Use, Maintenance and Servicing

Suggested Driving Air Pressure	Maximum Air Pressure
75 PSI	125 PSI
FAILURE TO MAINTAIN ADEQUATE MINIMUM PRESSURE (OR PRESSURE PROPORTIONAL TO LOAD) WILL RESULT IN BOTTOMING OUT, OVER-EXTENSION OR RUBBING AGAINST ANOTHER COMPONENT AND WILL <b>VOID THE WARRANTY.</b>	

## MAINTENANCE GUIDELINES

### NOTE

*By following these steps, vehicle owners will obtain the longest life and best results from their air spring.*

1. Check the air pressure before driving.
2. Never inflate beyond 125 PSI.
3. If you develop an air leak in the system, use a soapy water solution to check all air line connections, before deflating and removing the spring.
4. When increasing load, always adjust the air pressure to maintain normal ride height. Increase or decrease pressure from the system as necessary to attain normal ride height for optimal ride and handling. Remember that loads carried behind the axle (including tongue loads) require more leveling force (pressure) than those carried directly over the axle.

### CAUTION

FOR YOUR SAFETY AND TO PREVENT DAMAGE TO YOUR VEHICLE, DO NOT EXCEED MAXIMUM GROSS VEHICLE WEIGHT RATING (GVWR), AS INDICATED BY THE VEHICLE MANUFACTURER. ALTHOUGH YOUR AIR SPRINGS ARE RATED AT A MAXIMUM INFLATION PRESSURE OF 125 PSI, THE AIR PRESSURE ACTUALLY NEEDED IS DEPENDENT ON YOUR LOAD.

5. Always add air to the springs in small quantities, checking the pressure frequently. Sleeves require less air volume than a tire and inflate quickly.
6. Should it become necessary to raise the vehicle by the frame, make sure the control system is turned off before lifting.

## TROUBLESHOOTING GUIDE

1. Leak test the air line connections, the threaded connection into the air spring, and all fittings in the control system.
2. Inspect the air lines to be sure none are pinched. Tie straps may be too tight. Loosen or replace the strap and replace leaking components.
3. Inspect the air line for holes and cracks. Replace as needed.
4. Look for a kink or fold in the air line. Reroute as needed.

If the preceding steps do not solve the problem, it is possibly caused by a failed air spring — either a factory defect or an operating problem. Please call Air Lift at (800) 248-0892 for assistance.

## FREQUENTLY ASKED QUESTIONS

### **Q. Will installing air springs increase the weight ratings of a vehicle?**

No. Adding air springs will not change the weight ratings (GAWR, GCWR and/or GVWR) of a vehicle. Exceeding the GVWR is dangerous and voids the Air Lift warranty.

### **Q. How long should air springs last?**

If the air springs are properly installed and maintained they can last indefinitely.

**Q. Will raising the vehicle on a hoist for service work damage the air springs?**

No. The vehicle can be lifted on a hoist for short-term service work such as tire rotation or oil changes. However, if the vehicle will be on the hoist for a prolonged period of time, support the axle with jack stands in order to take the tension off of the air springs.

**TUNING THE AIR PRESSURE**

Pressure determination comes down to three things — level vehicle, ride comfort, and stability.

**1. Level vehicle**

If the vehicle's headlights are shining into the trees or the vehicle is leaning to one side, then it is not level. Raise the air pressure to correct either of these problems and level the vehicle.

**2. Ride comfort**

If the vehicle has a rough or harsh ride it may be due to either too much pressure or not enough. Try different pressures to determine the best ride comfort. See Air Lift suggested driving air pressure.

**3. Stability**

Stability translates into safety and should be the priority, meaning the driver may need to sacrifice a perfectly level and comfortable ride. Stability issues include roll control, bounce, dive during braking and sponginess. Tuning out these problems usually requires additional air pressure, strut damping, or both.

**CHECKING FOR LEAKS**

1. Inflate the air spring to 80 PSI.
2. Spray all connections and the inflation valves with a solution of 1/5 liquid dish soap and 4/5 water. Spot leaks easily by looking for bubbles in the soapy water.
3. After the test, deflate the springs to the minimum pressure required to restore the system to normal ride height.
4. Check the air pressure again after 24 hours. A 2 - 4 PSI loss after initial installation is normal. Retest for leaks if the loss is more than 5 lbs.

**FIXING LEAKS**

1. If there is a problem with a swivel fitting:
  - a. Check the air line connection by deflating the spring and removing the line by pulling the collar against the fitting and pulling firmly on the air line. Trim 1" off the end of the air line. Be sure the cut is clean and square (see fig. 22). Reinsert the air line into the push-to-connect fitting.
  - b. Check the threaded connection by tightening the swivel fitting another ½ turn. If it still leaks, deflate the air spring, remove the fitting, and re-coat the threads with thread sealant. Reinstall by hand tightening as much as possible and then use a wrench for an additional two turns.
2. If the preceding steps have not resolved the problem, call Air Lift customer service at (800) 248-0892.

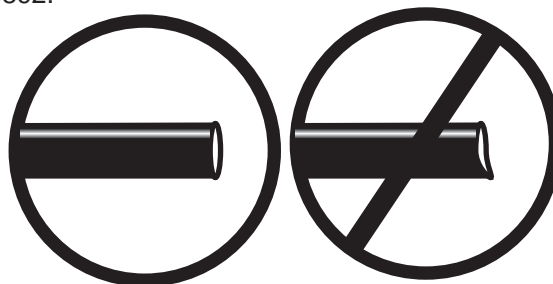

fig. 22

# Warranty and Returns Policy

Air Lift Company warrants its performance products for one year to the original purchaser against manufacturing defects one year from the date of purchase when used on cars and trucks as specified under normal operating conditions. The warranty does not apply to products that have been improperly applied, improperly installed, or which have not been maintained in accordance with installation instructions furnished with all products. The consumer will be responsible for removing (labor charges) the defective product from the vehicle and returning it, transportation costs prepaid, to the dealer from which it was purchased or to Air Lift Company for verification.

Air Lift will repair or replace, at its option, defective products or components. A minimum \$10.00 shipping and handling charge will apply to all warranty claims. Before returning any defective product, you must call Air Lift at (800) 248-0892 in the U.S. and Canada (elsewhere, (517) 322-2144) for a Returned Materials Authorization (RMA) number. Returns to Air Lift can be sent to: Air Lift Company • 2727 Snow Road • Lansing, MI • 48917.

Product failures resulting from abnormal use or misuse are excluded from this warranty. The loss of use of the product, loss of time, inconvenience, commercial loss or consequential damages is not covered. The consumer is responsible for installation/reinstallation (labor charges) of the product. Air Lift Company reserves the right to change the design of any product without assuming any obligation to modify any product previously manufactured.

This warranty gives you specific legal rights and you may also have other rights that may vary from state-to-state. Some states do not allow limitations on how long an implied warranty lasts or allow the exclusion or limitation of incidental or consequential damages. The above limitation or exclusion may not apply to you. There are no warranties, expressed or implied including any implied warranties of merchantability and fitness, which extend beyond this warranty period. There are no warranties that extend beyond the description on the face hereof. Seller disclaims the implied warranty of merchantability. (Dated proof of purchase required.)

## Replacement Information

If you need replacement parts, contact the local dealer or call Air Lift customer service at (800) 248-0892. Most parts are immediately available and can be shipped the same day.

### Contact Air Lift Company customer service at (800) 248-0892 first if:

- Parts are missing from the kit.
- Need technical assistance on installation or operation.
- Broken or defective parts in the kit.
- Wrong parts in the kit.
- Have a warranty claim or question.

### Contact the retailer where the kit was purchased:

- If it is necessary to return or exchange the kit for any reason.
- If there is a problem with shipping if shipped from the retailer.
- If there is a problem with the price.

## Contact Information

If you have any questions, comments or need technical assistance contact our customer service department by calling (800) 248-0892, Monday through Friday, 8 a.m. to 8 p.m. Eastern Time. For calls from outside the USA or Canada, our local number is (517) 322-2144. You may also contact customer service anytime by e-mail at [techsupport@airliftperformance.com](mailto:techsupport@airliftperformance.com).

For inquiries by mail, our address is PO Box 80167, Lansing, MI 48908-0167. Our shipping address for returns is 2727 Snow Road, Lansing, MI 48917.

You may also contact our sales team anytime by e-mail at [sales@airliftperformance.com](mailto:sales@airliftperformance.com) or on the web at [www.airliftperformance.com](http://www.airliftperformance.com).

---

# Notes

## Need Help?

Contact our customer service department by calling (800) 248-0892, Monday through Friday, 8 a.m. to 8 p.m. Eastern Time. For calls from outside the USA or Canada, our local number is (517) 322-2144.



*Thank you for purchasing Air Lift Performance products!*

Air Lift Company • 2727 Snow Road • Lansing, MI 48917 or PO Box 80167 • Lansing, MI 48908-0167  
Toll Free (800) 248-0892 • Local (517) 322-2144 • Fax (517) 322-0240 • [www.airliftperformance.com](http://www.airliftperformance.com)

Printed in  
the USA



**Air Lift**<sup>TM</sup>  
**PERFORMANCE**

**Kit 75677**

**Audi A6**  
**C6 Platform**  
**rear application**



## **INSTALLATION GUIDE**

For maximum effectiveness and safety, please read these instructions completely before proceeding with installation.

*Failure to read these instructions can result in an incorrect installation.*



# TABLE OF CONTENTS

<b>Introduction</b> .....	<b>2</b>
Notation Explanation .....	2
Important Safety Notices .....	2
<b>Installation Diagram</b> .....	<b>3</b>
Hardware List .....	3
<b>Installing the Air Suspension</b> .....	<b>4</b>
Preparing the Vehicle .....	4
Stock Suspension Removal .....	4
Air Suspension Installation .....	7
Damping Adjustment .....	9
Aligning the Vehicle .....	9
<b>Before Operating</b> .....	<b>10</b>
Installation Checklist .....	10
Post-installation checklist .....	10
<b>Product Use, Maintenance and Servicing</b> .....	<b>11</b>
Suggested Driving Air Pressure and Maximum Air Pressure .....	11
Maintenance Guidelines .....	11
Troubleshooting Guide .....	11
Frequently Asked Questions .....	11
Tuning the Air Pressure .....	12
Checking for Leaks .....	12
Fixing Leaks .....	12
<b>Warranty and Returns Policy</b> .....	<b>13</b>
<b>Replacement Information</b> .....	<b>13</b>
<b>Contact Information</b> .....	<b>13</b>

# Introduction

The purpose of this publication is to assist with the installation, maintenance and troubleshooting of this Audi Performance suspension kit.

It is important to read and understand the entire installation guide before beginning installation or performing any maintenance, service or repair. The information includes a hardware list, tool list, step-by-step installation information, maintenance tips, safety information and a troubleshooting guide.

Air Lift Company reserves the right to make changes and improvements to its products and publications at any time. For the latest version of this manual, contact Air Lift Company at (800) 248-0892 or visit our website at [www.airliftcompany.com](http://www.airliftcompany.com).

## NOTATION EXPLANATION

Hazard notations appear in various locations in this publication. Information which is highlighted by one of these notations must be observed to help minimize risk of personal injury or possible improper installation which may render the vehicle unsafe. Notes are used to help emphasize areas of procedural importance and provide helpful suggestions. The following definitions explain the use of these notations as they appear throughout this guide.

 **DANGER**

INDICATES IMMEDIATE HAZARDS WHICH WILL RESULT IN SEVERE PERSONAL INJURY OR DEATH.

 **WARNING**

INDICATES HAZARDS OR UNSAFE PRACTICES WHICH COULD RESULT IN SEVERE PERSONAL INJURY OR DEATH.

 **CAUTION**

INDICATES HAZARDS OR UNSAFE PRACTICES WHICH COULD RESULT IN DAMAGE TO THE MACHINE OR MINOR PERSONAL INJURY.

---

## NOTE

*Indicates a procedure, practice or hint which is important to highlight.*

---

## IMPORTANT SAFETY NOTICES

The installation of this kit does not alter the Gross Vehicle Weight Rating (GVWR) or payload of the vehicle. Check your vehicle's owner's manual and do not exceed the maximum load listed for your vehicle.

**Gross Vehicle Weight Rating:** The maximum allowable weight of the fully loaded vehicle (including passengers and cargo). This number — along with other weight limits, as well as tire, rim size and inflation pressure data — is shown on the vehicle's Safety Compliance Certification Label.

**Payload:** The combined, maximum allowable weight of cargo and passengers that the vehicle is designed to carry. Payload is GVWR minus the Base Curb Weight.

 **WARNING**

DO NOT INFLATE AIR SPRINGS WHILE OFF OF THE VEHICLE. DAMAGE TO ASSEMBLY MAY RESULT AND VOID WARRANTY.

 **CAUTION**

DO NOT WELD TO, OR MODIFY LIFESTYLE STRUTS/SHOCKS IN ANY WAY. DAMAGE TO UNIT MAY OCCUR AND WILL VOID WARRANTY.

# Installation Diagram

## HARDWARE LIST

Item	Part #	Description.....	Qty
A	13310	Spacer, Lower (2.4") .....	2
B	11801	Roll Plate.....	4
C	58526	Air Spring .....	2
D	13308	Spacer, Rear Upper .....	2
E	21745	1/4 MNPT X 1/4 PTC, Straight.....	2
F	18454	3/4-16 Nylon Hex Jam Nut.....	2
G	13983	Centering Spacer .....	2
H	17461	3/8-24 X 3.5 Hex Cap Screw.....	2
I	26967	Shock .....	2
J	21853	1/4MNPT X 3/8PTC, Straight.....	2

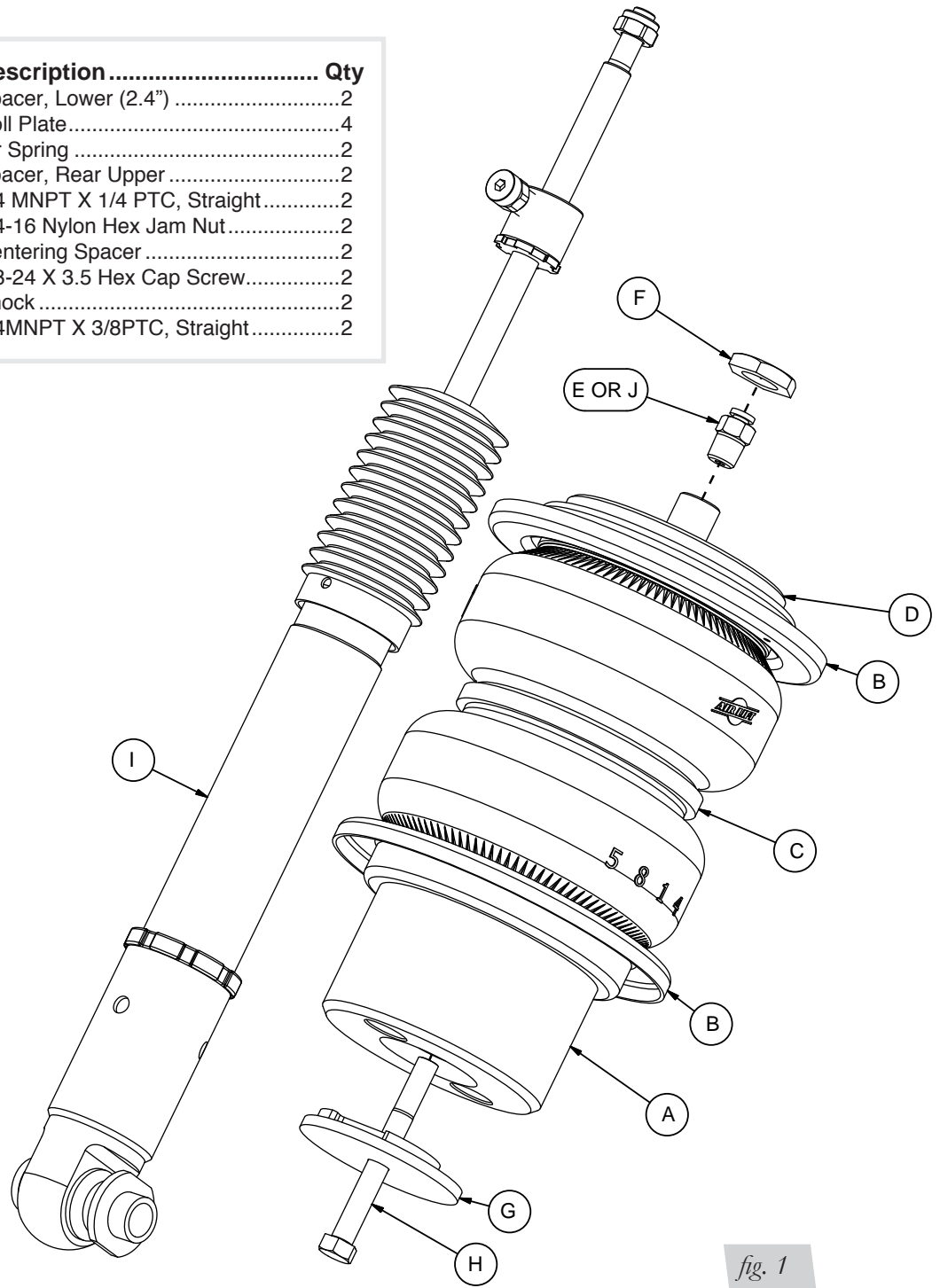

fig. 1

**STOP!** Missing or damaged parts? Call Air Lift customer service at (800) 248-0892 for a replacement part.

# Installing the Air Suspension

**NOTE**

The following instructions for factory suspension removal are based on a vehicle with coil spring suspension. If your vehicle is equipped with factory air suspension, please reference the factory service manual for the proper removal procedure.

## PREPARING THE VEHICLE

1. Support the vehicle with jack stands or a hoist at approved lifting points.
2. Remove the rear wheels.

**NOTE**

If equipped with a headlight alignment system, disconnect the range control linkage first (fig. 2).

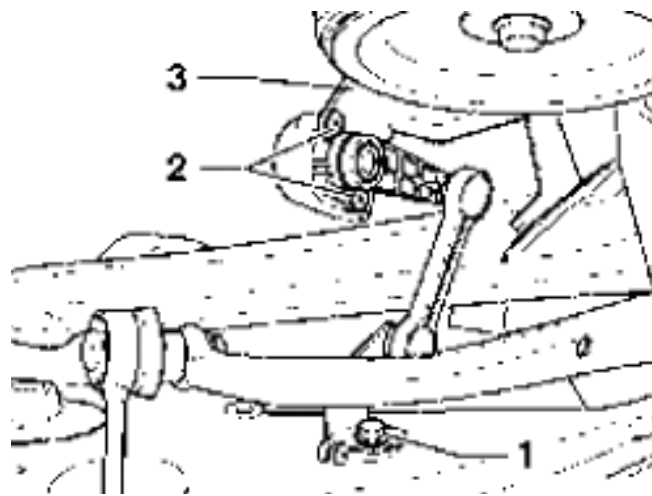
*fig. 2*

## STOCK SUSPENSION REMOVAL

1. Support the hub assembly before beginning work.
2. Remove the inner fender liners from both sides (fig. 3).

*fig. 3*



3. Unbolt the upper and lower shock mounts and remove from vehicle (figs. 4-6).



*fig. 4*



*fig. 5*



*fig. 6*

- Remove the nut from the top of the shock rod. Retain the upper mounting bracket for later use (fig. 7).



*fig. 7*

- Remove swaybar link to lower control arm bolts (fig. 8). Then remove rear coil springs and upper and lower rubber isolators (figs. 9 & 10).



*fig. 8*



*fig. 9*



*fig. 10*

- Directly above the upper coil spring perch, remove the rubber plug (figs. 11-12).



*fig. 11*

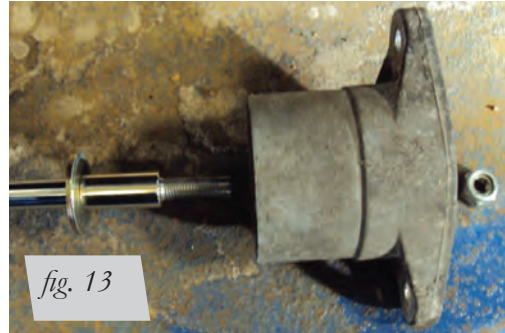

*fig. 12*



## AIR SUSPENSION INSTALLATION

1. Remove the nyloc nut from the top of the supplied shock rod. Leave the washer and spacer on the shock rod as received and cap with the OEM upper mount. Thread the nyloc nut on the shock rod (figs. 13 & 14). **DO NOT USE AN IMPACT WRENCH. If an impact wrench is used, damage will occur to the shock.** Tighten the nyloc nut on the shock rod to 27Nm (20 ft-lbs).



2. Attach the shock to the vehicle chassis and torque upper bracket bolts to 35Nm (26ft. /lbs). Attach but do not tighten the lower shock mount at this time.
3. Collapse the air spring and install into lower coil spring pocket with the threaded boss going through the vehicles upper coil spring perch (figs. 16-17). With the air spring assembly fully seated at the upper spring seat, check the clearance around the roll plate.



4. Carefully slide the plastic nut through the hole above the upper coil spring perch and thread onto the threaded boss (fig. 18). A flathead screwdriver can be used to lock the nut in place while the air spring is spun until tightened against the upper spring perch (fig. 19).



- Thread the supplied centering spacer, washer and bolt and thread into the air spring assembly through the lower control arm (fig. 20). Torque to 20Nm (15ft lbs).



*fig. 20*

- If using 3/8 PTC fittings, install now by wrapping fitting threads with Teflon tape or thread sealant and torque 1 3/4 turns beyond hand tight. **Some enlarging of the hole may assist in the installation of the 3/8" fittings.**
- Insert air line through hole into the air spring fitting. At this point, securely route the air line away from heat sources and suspension components (fig. 21). Best practice is to route the air line behind the fender liner paying close attention to shock travel. Failure to protect the line from the shock may result in kinky hose.

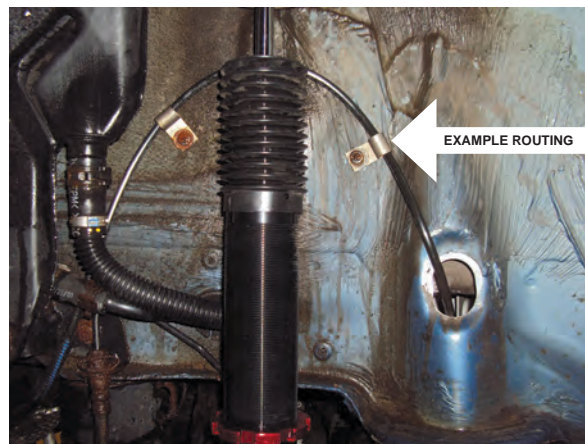

*fig. 21*

- Compress the suspension fully and check clearance around the air spring and air line.
- Reattach the inner fender liners and wheels.
- This is the time to develop a preferred ride height. With the suspension fully compressed, take a measurement from the fender to the lower wheel lip. Record this as Max Compression (MC). Cycle the suspension to Max Extension (ME) and record the measurement from the same reference points. Take the difference between the two numbers and divide by two. Add that value to the Max Compression number and then set the suspension to that point (fig. 22). This position gives 50% stroke in either position and is a great starting point for ride height. At this position loosen all pivot points and bounce the vehicle several times. This will "reset" the bushings to the new lowered height. At the desired ride height re-torque the pivot points to the manufacturers specifications.

Formula for calculating ride height:

Step 1:	Step 2:	Step 3:	Answer:	<i>fig. 22</i>
$\frac{ME - MC}{X}$	$\frac{X}{2} = Y$	$\frac{Y + MC}{Z}$	<b>Z = DESIGN HEIGHT</b>	

## DAMPING ADJUSTMENT

The shocks in this kit have 30 settings or “clicks” of adjustable compression and rebound damping characteristics. Damping is changed through the shock rod using the supplied adjuster or a 3mm Allen wrench. Turn the adjuster clockwise and the damping settings are hardened. Turn the adjuster counterclockwise and the damping is softened. Each rear shock is preset to “-13 clicks”. This means that the shock is adjusted 13 clicks away from full stiff. Counting down from full stiff is the preferred method of keeping track/setting of damping. This setting was developed on a 2006 Audi A6 Quattro sedan and may need to be adjusted to the different vehicles and driving characteristics.



fig. 23



fig. 24

## ALIGNING THE VEHICLE

1. Using the control system, set the vehicle height to the new custom ride height.
2. If the custom ride height is lower than stock, we recommend loosening all pivot points (bolts, nuts) on any control arm, strut arm or radius rod that contains bushings (fig. 7). Once they have been loosened, re-torque to stock specifications.

---

### NOTE

*It may be necessary to cycle the suspension to loosen the bushing up from its mount. This will help re-orient the bushing at its new position based on the custom ride height.*

---

# Before Operating

**CAUTION**

MAKE SURE THE FRONT WHEELS ARE STRAIGHT WHEN DEFLATING AND REINFLATING AIR BAGS.

1. Inflate and deflate the system (do not exceed 125 PSI) to check for clearance or binding issues. With the air springs deflated, check clearances on everything so as not to pinch brake lines, vent tubes, etc. Clear lines if necessary.
2. Inflate the air springs to 75PSI - 90PSI and check all connections for leaks.
3. Air Lift part #27669 or #27671, AutoPilot V2 Air Management System, is highly recommended for this product.
4. Please continue by reading the Product Use, Maintenance and Servicing section.

## INSTALLATION CHECKLIST

- Clearance test — Inflate the air springs to 75-90 PSI and make sure there is at least ½” clearance from anything that might rub against each sleeve. Be sure to check the tire, brake drum, frame, shock absorbers and brake cables.
- Leak test before road test — Inflate the air springs to 75PSI - 90PSI and check all connections for leaks. All leaks must be eliminated before the vehicle is road tested.
- Heat test — Be sure there is sufficient clearance from heat sources, at least 6” for air springs and air lines. If a heat shield was included in the kit, install it. If there is no heat shield, but one is required, call Air Lift customer service at (800) 248-0892.
- Fastener test — Recheck all bolts for proper torque.
- Road test — The vehicle should be road tested after the preceding tests. Inflate the springs to recommended driving pressures. Drive the vehicle 10 miles and recheck for clearance, loose fasteners and air leaks.
- Operating instructions — If professionally installed, the installer should review the operating instructions with the owner. Be sure to provide the owner with all of the paperwork that came with the kit.

**Technician's Signature** \_\_\_\_\_

**Date** \_\_\_\_\_

## POST-INSTALLATION CHECKLIST

- Overnight leak down test — Recheck air pressure after the vehicle has been used for 24 hours. If the pressure has dropped more than 5 PSI, then there is a leak that must be fixed. Either fix the leak yourself or return to the installer for service.
- Air pressure requirements — I understand the air pressure requirements of my air spring system. Regardless of load, the air pressure should always be adjusted to maintain adequate ride height at all times while driving.
- Thirty day or 500 mile test — I understand that I must recheck the air spring system after 30 days or 500 miles, whichever comes first. If any part shows signs of rubbing or abrasion, the source should be identified and moved, if possible. If it is not possible to relocate the cause of the abrasion, the air spring may need to be remounted. If professionally installed, the installer should be consulted. Check all fasteners for tightness.



# Product Use, Maintenance and Servicing

Suggested Driving Air Pressure	Maximum Air Pressure
60 PSI	125 PSI
FAILURE TO MAINTAIN ADEQUATE MINIMUM PRESSURE (OR PRESSURE PROPORTIONAL TO LOAD) WILL RESULT IN BOTTOMING OUT, OVER-EXTENSION OR RUBBING AGAINST ANOTHER COMPONENT AND WILL <b>VOID THE WARRANTY.</b>	

## MAINTENANCE GUIDELINES

### NOTE

*By following these steps, vehicle owners will obtain the longest life and best results from their air spring.*

1. Check the air pressure before driving.
2. Never inflate beyond 125 PSI.
3. If you develop an air leak in the system, use a soapy water solution to check all air line connections, before deflating and removing the spring.
4. When increasing load, always adjust the air pressure to maintain normal ride height. Increase or decrease pressure from the system as necessary to attain normal ride height for optimal ride and handling. Remember that loads carried behind the axle (including tongue loads) require more leveling force (pressure) than those carried directly over the axle.

### CAUTION

FOR YOUR SAFETY AND TO PREVENT DAMAGE TO YOUR VEHICLE, DO NOT EXCEED MAXIMUM GROSS VEHICLE WEIGHT RATING (GVWR), AS INDICATED BY THE VEHICLE MANUFACTURER. ALTHOUGH YOUR AIR SPRINGS ARE RATED AT A MAXIMUM INFLATION PRESSURE OF 125 PSI, THE AIR PRESSURE ACTUALLY NEEDED IS DEPENDENT ON YOUR LOAD.

5. Always add air to the springs in small quantities, checking the pressure frequently. Sleeves require less air volume than a tire and inflate quickly.
6. Should it become necessary to raise the vehicle by the frame, make sure the control system is turned off before lifting.

## TROUBLESHOOTING GUIDE

1. Leak test the air line connections, the threaded connection into the air spring, and all fittings in the control system.
2. Inspect the air lines to be sure none are pinched. Tie straps may be too tight. Loosen or replace the strap and replace leaking components.
3. Inspect the air line for holes and cracks. Replace as needed.
4. Look for a kink or fold in the air line. Reroute as needed.

If the preceding steps do not solve the problem, it is possibly caused by a failed air spring — either a factory defect or an operating problem. Please call Air Lift at (800) 248-0892 for assistance.

## FREQUENTLY ASKED QUESTIONS

### Q. Will installing air springs increase the weight ratings of a vehicle?

No. Adding air springs will not change the weight ratings (GAWR, GCWR and/or GVWR) of a vehicle. Exceeding the GVWR is dangerous and voids the Air Lift warranty.

### Q. How long should air springs last?

If the air springs are properly installed and maintained they can last indefinitely.

## Q. Will raising the vehicle on a hoist for service work damage the air springs?

No. The vehicle can be lifted on a hoist for short-term service work such as tire rotation or oil changes. However, if the vehicle will be on the hoist for a prolonged period of time, support the axle with jack stands in order to take the tension off of the air springs.

## TUNING THE AIR PRESSURE

Pressure determination comes down to three things — level vehicle, ride comfort, and stability.

### 1. Level vehicle

If the vehicle's headlights are shining into the trees or the vehicle is leaning to one side, then it is not level. Raise the air pressure to correct either of these problems and level the vehicle.

### 2. Ride comfort

If the vehicle has a rough or harsh ride it may be due to either too much pressure or not enough. Try different pressures to determine the best ride comfort. See Air Lift suggested driving air pressure.

### 3. Stability

Stability translates into safety and should be the priority, meaning the driver may need to sacrifice a perfectly level and comfortable ride. Stability issues include roll control, bounce, dive during braking and sponginess. Tuning out these problems usually requires additional air pressure, strut damping, or both.

## CHECKING FOR LEAKS

1. Inflate the air spring to 80 PSI.
2. Spray all connections and the inflation valves with a solution of 1/5 liquid dish soap and 4/5 water. Spot leaks easily by looking for bubbles in the soapy water.
3. After the test, deflate the springs to the minimum pressure required to restore the system to normal ride height.
4. Check the air pressure again after 24 hours. A 2 - 4 PSI loss after initial installation is normal. Retest for leaks if the loss is more than 5 lbs.

## FIXING LEAKS

1. If there is a problem with a swivel fitting:
  - a. Check the air line connection by deflating the spring and removing the line by pulling the collar against the fitting and pulling firmly on the air line. Trim 1" off the end of the air line. Be sure the cut is clean and square (see fig. 25). Reinsert the air line into the push-to-connect fitting.
  - b. Check the threaded connection by tightening the swivel fitting another ½ turn. If it still leaks, deflate the air spring, remove the fitting, and re-coat the threads with thread sealant. Reinstall by hand tightening as much as possible and then use a wrench for an additional two turns.
2. If the preceding steps have not resolved the problem, call Air Lift customer service at (800) 248-0892.

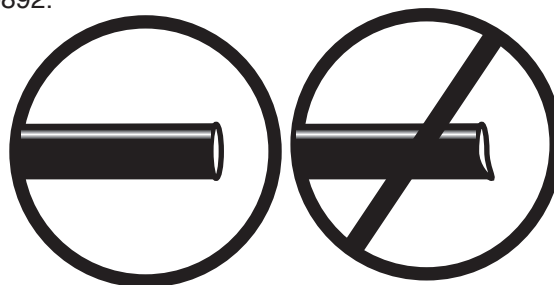

fig. 25



# Warranty and Returns Policy

Air Lift Company warrants its performance products for one year to the original purchaser against manufacturing defects one year from the date of purchase when used on cars and trucks as specified under normal operating conditions. The warranty does not apply to products that have been improperly applied, improperly installed, or which have not been maintained in accordance with installation instructions furnished with all products. The consumer will be responsible for removing (labor charges) the defective product from the vehicle and returning it, transportation costs prepaid, to the dealer from which it was purchased or to Air Lift Company for verification.

Air Lift will repair or replace, at its option, defective products or components. A minimum \$10.00 shipping and handling charge will apply to all warranty claims. Before returning any defective product, you must call Air Lift at (800) 248-0892 in the U.S. and Canada (elsewhere, (517) 322-2144) for a Returned Materials Authorization (RMA) number. Returns to Air Lift can be sent to: Air Lift Company • 2727 Snow Road • Lansing, MI • 48917.

Product failures resulting from abnormal use or misuse are excluded from this warranty. The loss of use of the product, loss of time, inconvenience, commercial loss or consequential damages is not covered. The consumer is responsible for installation/reinstallation (labor charges) of the product. Air Lift Company reserves the right to change the design of any product without assuming any obligation to modify any product previously manufactured.

This warranty gives you specific legal rights and you may also have other rights that may vary from state-to-state. Some states do not allow limitations on how long an implied warranty lasts or allow the exclusion or limitation of incidental or consequential damages. The above limitation or exclusion may not apply to you. There are no warranties, expressed or implied including any implied warranties of merchantability and fitness, which extend beyond this warranty period. There are no warranties that extend beyond the description on the face hereof. Seller disclaims the implied warranty of merchantability. (Dated proof of purchase required.)

## Replacement Information

If you need replacement parts, contact the local dealer or call Air Lift customer service at (800) 248-0892. Most parts are immediately available and can be shipped the same day.

**Contact Air Lift Company customer service at (800) 248-0892 first if:**

- Parts are missing from the kit.
- Need technical assistance on installation or operation.
- Broken or defective parts in the kit.
- Wrong parts in the kit.
- Have a warranty claim or question.

**Contact the retailer where the kit was purchased:**

- If it is necessary to return or exchange the kit for any reason.
- If there is a problem with shipping if shipped from the retailer.
- If there is a problem with the price.

## Contact Information

If you have any questions, comments or need technical assistance contact our customer service department by calling (800) 248-0892, Monday through Friday, 8 a.m. to 8 p.m. Eastern Time. For calls from outside the USA or Canada, our local number is (517) 322-2144. You may also contact customer service anytime by e-mail at [techsupport@airliftperformance.com](mailto:techsupport@airliftperformance.com).

For inquiries by mail, our address is PO Box 80167, Lansing, MI 48908-0167. Our shipping address for returns is 2727 Snow Road, Lansing, MI 48917.

You may also contact our sales team anytime by e-mail at [sales@airliftperformance.com](mailto:sales@airliftperformance.com) or on the web at [www.airliftperformance.com](http://www.airliftperformance.com).

## Need Help?

Contact our customer service department by calling (800) 248-0892, Monday through Friday, 8 a.m. to 8 p.m. Eastern Time. For calls from outside the USA or Canada, our local number is (517) 322-2144.



*Thank you for purchasing Air Lift Performance products!*

Air Lift Company • 2727 Snow Road • Lansing, MI 48917 or PO Box 80167 • Lansing, MI 48908-0167  
Toll Free (800) 248-0892 • Local (517) 322-2144 • Fax (517) 322-0240 • [www.airliftperformance.com](http://www.airliftperformance.com)

Printed in  
the USA

# **Air Lift**<sup>™</sup> **PERFORMANCE**

## **Kit 27666** Manual Air Management System



## **INSTALLATION GUIDE**

For maximum effectiveness and safety, please read these instructions completely before proceeding with installation.

*Failure to read these instructions can result in an incorrect installation.*





# TABLE OF CONTENTS

<b>Introduction</b> .....	<b>2</b>
Important Safety Notice .....	2
Notation Explanation .....	2
<b>Hardware List</b> .....	<b>3</b>
NPT Assembly Instructions .....	3
Helpful Tips: Air Line and Fittings .....	3
<b>Installing the Air Management System</b> .....	<b>4</b>
Install Components .....	4
Mounting the Switch Panel .....	5
Attaching the Air Lines .....	5
<b>Troubleshooting Guide</b> .....	<b>6</b>
<b>Tuning the Air Pressure</b> .....	<b>7</b>
<b>Leak Testing and Detection</b> .....	<b>7</b>
<b>Installation Diagram</b> .....	<b>8-9</b>
<b>Warranty and Returns Policy</b> .....	<b>10</b>
<b>Replacement Information</b> .....	<b>11</b>
<b>Contact Information</b> .....	<b>11</b>
<b>Electrical Schematic</b> .....	<b>12</b>
<b>Paddle Switch Mounting Bracket Template</b> .....	<b>13</b>
<b>16380 Compressor Template</b> .....	<b>15</b>



# Introduction

The purpose of this publication is to assist with the installation, maintenance and troubleshooting of the Air Management System.

It is important to read and understand the entire installation guide before beginning installation or performing any maintenance, service or repair. The information here includes a hardware list, tool list, step-by-step installation information, maintenance guidelines and troubleshooting guide.

Air Lift Company reserves the right to make changes and improvements to its products and publications at any time. For the latest version of this manual, contact Air Lift Company at (800) 248-0892 or visit our website at [www.airliftcompany.com](http://www.airliftcompany.com).

## IMPORTANT SAFETY NOTICE

The installation of this kit does not alter the Gross Vehicle Weight Rating (GVWR) or payload of the vehicle. Check your vehicle's owner's manual and do not exceed the maximum load listed for your vehicle.

**Gross Vehicle Weight Rating:** The maximum allowable weight of the fully loaded vehicle (including passengers and cargo). This number — along with other weight limits, as well as tire, rim size and inflation pressure data — is shown on the vehicle's Safety Compliance Certification Label.

**Payload:** The combined, maximum allowable weight of cargo and passengers that the vehicle is designed to carry. Payload is GVWR minus the Base Curb Weight.

## NOTATION EXPLANATION

Hazard notations appear in various locations in this publication. Information which is highlighted by one of these notations must be observed to help minimize risk of personal injury or possible improper installation which may render the vehicle unsafe. Notes are used to help emphasize areas of procedural importance and provide helpful suggestions. The following definitions explain the use of these notations as they appear throughout this guide.

 **DANGER**

INDICATES IMMEDIATE HAZARDS WHICH WILL RESULT IN SEVERE PERSONAL INJURY OR DEATH.

 **WARNING**

INDICATES HAZARDS OR UNSAFE PRACTICES WHICH COULD RESULT IN SEVERE PERSONAL INJURY OR DEATH.

 **CAUTION**

INDICATES HAZARDS OR UNSAFE PRACTICES WHICH COULD RESULT IN DAMAGE TO THE MACHINE OR MINOR PERSONAL INJURY.

---

## NOTE

*Indicates a procedure, practice or hint which is important to highlight.*

---

# Hardware List

Item	Part #	Description	Quantity	Item	Part #	Description	Quantity
A	16380	Viair 380C Compressor	1	<b>Electrical</b>			
B	11955	4 Gallon Aluminum Air Tank	1	S	24782	30/50A Relay	1
C	26228	Dual Needle Gauge	2	T	24608	10 Gauge Red Wire	15'
D	21703	Paddle Switch	4	U	24643	16 Gauge Red Wire	20'
E	11031	Paddle Switch Mounting Bracket	1	V	24644	16 Gauge Black Wire	10'
F	20946	1/4" Airline	80'	W	24537	Quick Splice	3
G	10530	Air Line Cutter	1	X	24568	18 Gauge Ring Terminal	2
H	24575	145 - 175 PSI Pressure Switch	1	Y	24594	Blue Female Spade Terminal	9
<b>Paddle Switch Mounting Bracket Hardware</b>				Z	24748	12 Gauge Ring Terminal 3/8" ID	1
I	17434	#8 x 3/4" Stainless Steel Screw	4	AA	24542	Fuse Tap	1
<b>Tank Mounting Hardware</b>				BB	24561	Mini Fuse Adapter	1
J	17188	3/8"-16 x 1.25" Grade 5 Bolt	4	CC	24649	Yellow Butt Connector	1
K	18444	3/8" Flat Washer	8	DD	24595	Yellow Female Spade Terminal	2
L	18435	3/8"-16 Nyloc Nut	4	EE	17263	1/4" x 1" Self Threading Screw	1
<b>Tank Fittings</b>				FF	24539	Fuse Holder	1
M	21737	3/8" Pipe Plug	1	GG	24547	30A Spade Fuse	1
N	21738	1/4" FNPT x 3/8" MNPT Bushing	1	HH	17132	1/2" Self Threading Screw	2
O	21779	1/4" NPT x 1/4" Tube Elbow	2	<b>Gauge and Paddle Switch Fittings</b>			
P	21610	1/8" FNPT x 1/4" MNPT Bushing	1	II	21838	1/4" Union Tee	4
Q	21633	Inflation Valve	1	JJ	21842	1/4" Y Tee	3
R	23586	Thread Sealant	1				



Missing or damaged parts? Call Air Lift customer service at (800) 248-0892 for a replacement part.

## NPT ASSEMBLY INSTRUCTIONS

1. Inspect the port and fitting ensuring both are free of contaminants and excessive burrs and nicks.
2. Apply a stripe of liquid pipe sealant around the male threads leaving the first two threads uncovered.
3. Screw finger tight into the port.
4. Wrench tighten the fitting to the correct turns past finger tight position (see table 1).



NEVER BACK OFF AN INSTALLED PIPE FITTING TO ACHIEVE PROPER ALIGNMENT. LOOSENING INSTALLED PIPE FITTINGS WILL CORRUPT THE SEAL AND CONTRIBUTE TO LEAKAGE AND FAILURE.

Torque Specifications		
Fitting Size	Turns Past Finger Tight	Torque lb/ft
1/8" NPT	1.5 - 3.0	12
1/4" NPT	1.5 - 3.0	25
3/8" NPT	1.5 - 3.0	40
1/2" NPT	1.5 - 3.0	54
3/4" NPT	1.5 - 3.0	78
1" NPT	1 - 2.5	112
1 1/4" NPT	1 - 2.5	154
1 1/2" NPT	1 - 2.5	211
2" NPT	1 - 2.5	300

Table 1



## HELPFUL TIPS: AIR LINE AND FITTINGS

1. Minimum hose bend radius
  - 1/4" hose = 1" hose bend radius.
2. Hose to fitting
  - No side loading on fitting from hose.
  - Hose straight for 1" before bending.
3. Hose cutting
  - Cut hose perpendicular to hose length.
  - Inspect hose for scratches that run lengthwise on hose prior to insertion.
  - Use proper hose cutter, cigar cutter, or razor on flat surface.
4. DOT/SAEJ844 air brake hose data
  - Maximum working pressure of 175 PSI.
  - Not to be used for frame (body) to un-sprung mass connection, use a braided leader hose for this moving connection.

Compressor Tank Pressure		
Viair	Air Lift P/N	Max. Tank Pressure
380C	16380	175
400C	16400	150
444C	16444	175
450C	16450	150

*Table 2*

# Installing the Air Management System

## INSTALL COMPONENTS

**NOTE**

*For a complete schematic, please see fig. 1. (pages 8 – 9)*

### **Layout**

1. Plan component location first.
2. Prior to mounting components, check to make sure:
  - the compressor leader hose will reach the tank.
  - the plumbing will route cleanly through the vehicle.

**NOTE**

*Be sure to install all components as far as possible from any heat sources. Plan and prepare wiring and plumbing routing thru the vehicle. Eliminate all sharp edges that could chafe. Use grommets when passing through compartment walls.*

### **Prepare and install the compressor**

1. Prepare the compressor intake. If inside the vehicle, attach filter to port on end of compressor (fig. 1). If the compressor is located outside the vehicle, snorkel inlet filter to a dry location inside vehicle using components supplied with the compressor.
2. Center punch and drill four holes using the template on page 15.
3. Attach using the hardware supplied with the compressor.

**NOTE**

*Air compressors ingest moisture and will deposit water in the tank. Tanks must be regularly purged to eliminate the possibility of water freezing inside the system or causing corrosion. Be sure to provide easy access to drain/fill valve (preferably outside the vehicle). The system does not include moisture separators or water traps, and does require periodic tank moisture drain. If using an engine driven compressor, proper oil and water filtration must be added as these compressors will contaminate the air suspension system. Water traps are available and sold separately through Air Lift Performance, part numbers: 21011 (1/4"), 21012 (3/8"), 21013 (1/2").*

**Tank pre-assembly** (see fig. 1)

1. Determine tank location and orientation prior to installing fittings.
2. Apply thread sealant as necessary to all fittings.
3. Install the drain/fill PTC fitting in the lower most tank threaded port.
4. Choose a tank threaded port for the compressor fitting.
5. Choose the highest tank threaded port for air line supply.
6. Plug any remaining tank ports with hex plugs.

**Tank install** (see fig. 1)

1. Using the tank feet as a template, drill holes for hardware assembly.
2. Attach the tank using the supplied hardware.
3. Cut an appropriate length of hose from the manifold port T, to the PTC fitting on the tank.
4. Route the drain/fill air line with a schrader valve (preferably outside the vehicle).

**NOTE**

*When cutting plastic air line, only use a standard hose cutter like (Air Lift part number 10530) or razorblade. Cut all hose ends square and as smoothly as possible. See hose cutting tips on page 4.*

**MOUNTING THE SWITCH PANEL**

Refer to the switch panel template on page 13.

1. Find a location to mount the paddle switch mounting bracket (E).
2. Snap all four paddle switches (D) into the paddle switch mounting bracket (E) so the DEL is toward the top.

**NOTE**

*You may select different locations for the paddle switches. The paddle switches do not need to be used with the supplied paddle switch mounting bracket.*

3. Cut six pieces of air line (F) the same length (approximately 3"-6").
4. Push four of these pieces onto the "SUP" port of the switch. Attach two Y fittings (JJ) to the air lines.
5. Push the other two pieces of line into the Y fittings (JJ).
6. Attach the last Y fitting (JJ) to the air lines.
7. Mount the paddle switch mounting bracket (E) with four screws (I).

**ATTACHING THE AIR LINES** **CAUTION**

WHEN CUTTING OR TRIMMING THE AIR LINE, USE AN AIR LINE CUTTER (G), A RAZOR BLADE OR A SHARP KNIFE. A CLEAN, SQUARE CUT WILL ENSURE AGAINST LEAKS. DO NOT USE WIRE CUTTERS OR SCISSORS TO CUT THE AIR LINE. THESE TOOLS MAY FLATTEN OR CRIMP THE AIR LINE, CAUSING IT TO LEAK.

1. Run a length of air line (F) from the air fitting on the compressor to the end of the switch cluster.
2. Run a length of air line from the remaining air fittings on the switch to its respective air spring.
3. Repeat step 2 for the remaining air fittings and air springs.
4. Use a tee and connect into each one of the air spring lines to connect to its respective gauge port.
5. Test and make sure that the switches operate the appropriate air springs.

# Troubleshooting Guide

For further technical assistance please contact our customer service department by calling (800) 248-0892, Monday through Friday. For calls from outside the USA or Canada, our local number is (517) 322-2144.

<b>PROBLEM</b>	<b>CAUSE</b>	<b>SOLUTION</b>
<i>Compressor doesn't run</i>	There is a blown fuse or relay, bad ground, or poor electrical connections.	Replace the fuse, check the ground wire, or check the compressor connector
<i>Compressor runs all the time.</i>	The compressor relay is defective or there is a leak.	Replace the relay or locate the leak and repair.
<i>Air spring or tank leak.</i>	Fitting seal or air line is compromised.	Check to make sure air lines are seated in connectors. Inspect fittings with soapy water. Trim hose or re-seal fitting.
<i>Compressors runs all the time but doesn't fill the tank.</i>	Compressor in-line check valve fitting has been overtorqued.	Loosen fitting and check again. Replace if needed.

---

# Tuning the Air Pressure

Pressure determination comes down to three things — level vehicle, ride comfort, and stability.

## 1. Level vehicle

If the vehicle's headlights are shining into the trees or the vehicle is leaning to one side, then it is not level. Raise the air pressure to correct either of these problems and level the vehicle.

## 2. Ride comfort

If the vehicle has a rough or harsh ride it may be due to either too much pressure or not enough. Try different pressures to determine the best ride comfort.

## 3. Stability

Stability translates into safety and should be the priority, meaning the driver may need to sacrifice a perfectly level and comfortable ride. Stability issues include roll control, bounce, dive during braking and sponginess. Tuning out these problems usually requires an increase in pressure.

# Leak Testing and Detection

## *Leak detection*

1. A leak can be defined as a loss of pressure of more than 5 psi over an 8 hour period. Be aware that ambient temperature change has an effect on pressure that may seem like a leak. For example: a change of 10° Fahrenheit up or down from your baseline will have an approximate gain or loss of indicated pressure of 2 psi. If a leak is suspected after including any temperature change, then proceed to #2.
2. Spray soapy water (1/5 Dawn brand dish soap to 4/5 water) on suspect fittings and hose connections and look for any bubbling caused by air leakage.
3. Fix leaking connection (review pages 3 and 4 for help on NPT fittings and air line connections).
4. Wipe down sprayed connections with rag to remove any residual soapy water.

---

## NOTE

*Dawn brand dish soap will not corrode the metals (aluminum, brass, steel) with which it comes into contact.*

---

# Installation Diagram

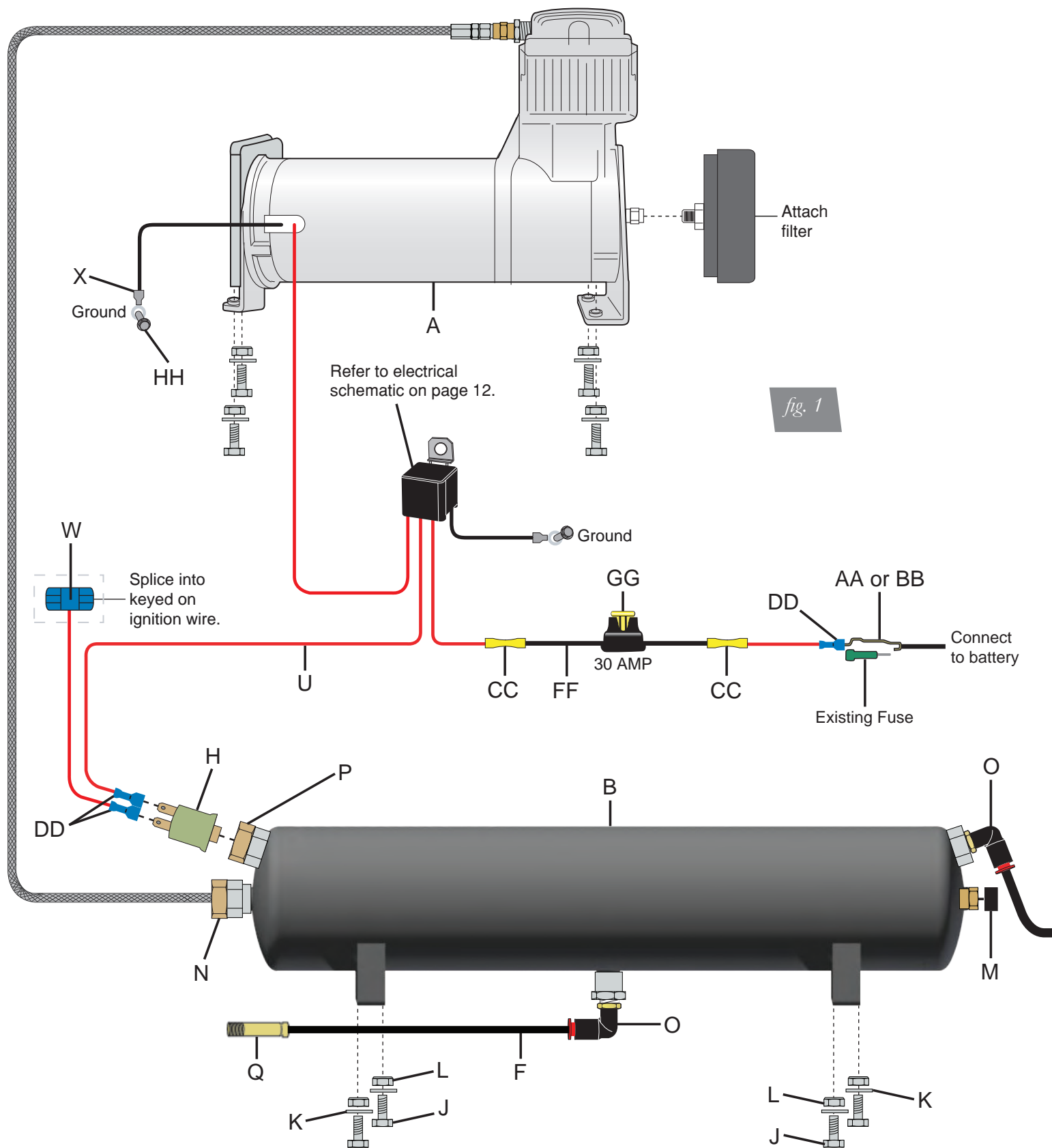

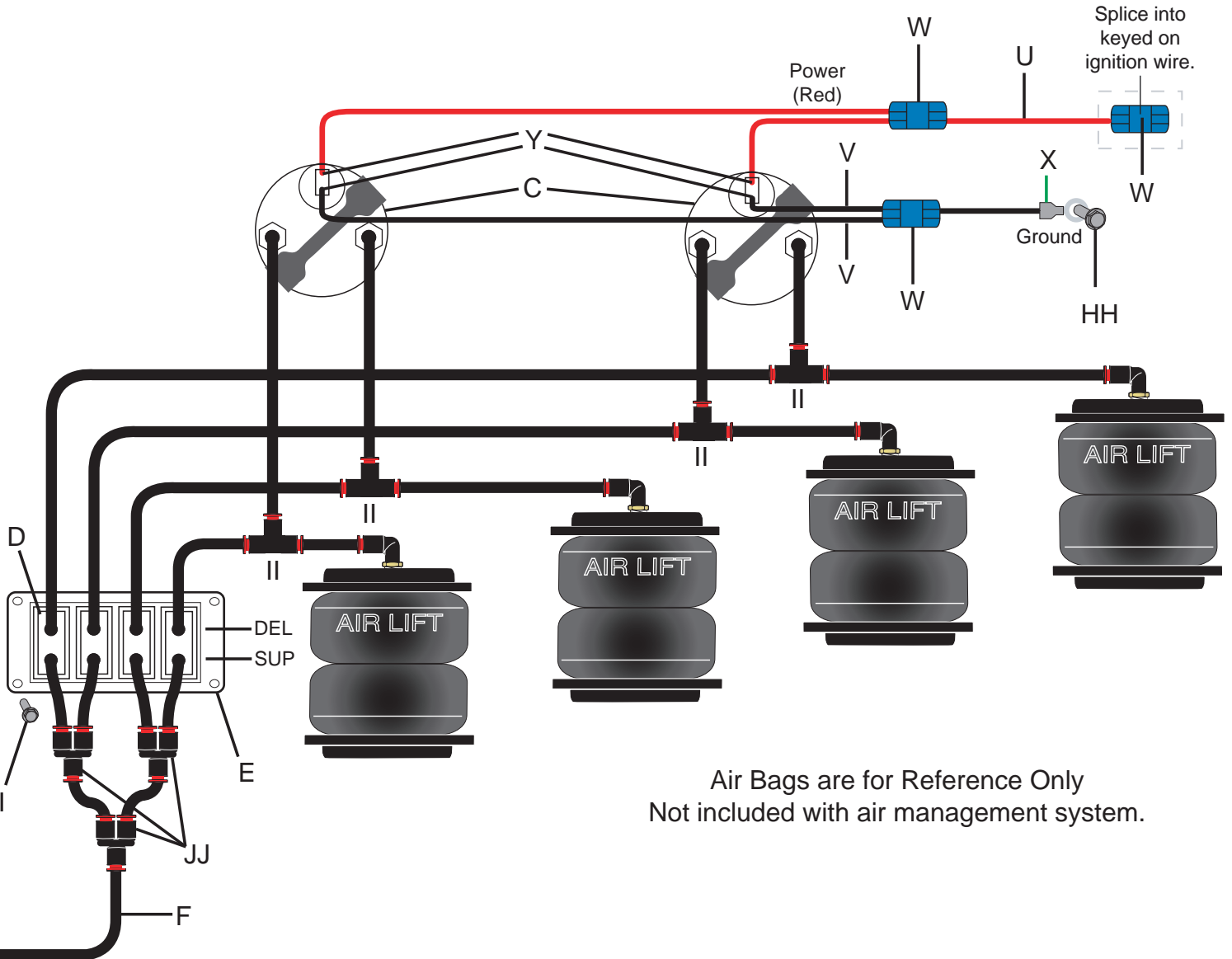
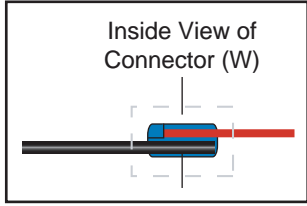

Air Bags are for Reference Only  
Not included with air management system.

**NOTE:** Air Lift recommends using a hose cutting tool to ensure a proper cut. If a hose connection has been disconnected the hose must be trimmed 1/2" back to provide for a leak free seal.

# Warranty and Returns Policy

Air Lift Company warrants its products, for the time periods listed below, to the original retail purchaser against manufacturing defects when used on catalog-listed applications on cars, vans, light trucks and motorhomes under normal operating conditions for as long as Air Lift manufactures the product. The warranty does not apply to products that have been improperly applied, improperly installed, used in racing or off-road applications, used for commercial purposes, or which have not been maintained in accordance with installation instructions furnished with all products. The consumer will be responsible for removing (labor charges) the defective product from the vehicle and returning it, transportation costs prepaid, to the dealer from which it was purchased or to Air Lift Company for verification.

Air Lift will repair or replace, at its option, defective products or components. A minimum \$10.00 shipping and handling charge will apply to all warranty claims. Before returning any defective product, you must call Air Lift at (800) 248-0892 in the U.S. and Canada (elsewhere, (517) 322-2144) for a Returned Materials Authorization (RMA) number. Returns to Air Lift can be sent to: Air Lift Company • 2727 Snow Road • Lansing, MI • 48917.

Product failures resulting from abnormal use or misuse are excluded from this warranty. The loss of use of the product, loss of time, inconvenience, commercial loss or consequential damages is not covered. The consumer is responsible for installation/reinstallation (labor charges) of the product. Air Lift Company reserves the right to change the design of any product without assuming any obligation to modify any product previously manufactured.

This warranty gives you specific legal rights and you may also have other rights that vary from state-to-state. Some states do not allow limitations on how long an implied warranty lasts or allow the exclusion or limitation of incidental or consequential damages. The above limitation or exclusion may not apply to you. There are no warranties, expressed or implied including any implied warranties of merchantability and fitness, which extend beyond this warranty period. There are no warranties that extend beyond the description on the face hereof. Seller disclaims the implied warranty of merchantability. (Dated proof of purchase required.)

<b>Air Lift 1000™</b> .....	<b>Lifetime Limited</b>	<b>LoadController/Dual™</b> .....	<b>2 Year Limited</b>
<b>RideControl™</b> .....	<b>Lifetime Limited</b>	<b>Load Controller™ (I)</b> .....	<b>2 Year Limited</b>
<b>LoadLifter 5000™*</b> .....	<b>Lifetime Limited</b>	<b>Load Controller™ (II)</b> .....	<b>2 Year Limited</b>
<b>SlamAir™</b> .....	<b>Lifetime Limited</b>	<b>SmartAir™</b> .....	<b>2 Year Limited</b>
<b>AirCell™</b> .....	<b>Lifetime Limited</b>	<b>Wireless AIR™</b> .....	<b>2 Year Limited</b>
<b>Air Lift Performance™**</b> .....	<b>1 Year Limited</b>	<b>WirelessONE™</b> .....	<b>2 Year Limited</b>
<b>LoadController/Single™</b> ..	<b>2 Year Limited</b>	<b>Other Accessories</b> .....	<b>2 Year Limited</b>

*\*formerly SuperDuty*

*\*\*formerly LifeStyle & Performance and Easystreet*



---

# Replacement Information

If you need replacement parts, contact the local dealer or call Air Lift customer service at (800) 248-0892. Most parts are immediately available and can be shipped the same day.

**Contact Air Lift Company customer service at (800) 248-0892 first if:**

- Parts are missing from the kit.
- Need technical assistance on installation or operation.
- Broken or defective parts in the kit.
- Wrong parts in the kit.
- Have a warranty claim or question.

**Contact the retailer where the kit was purchased:**

- If it is necessary to return or exchange the kit for any reason.
- If there is a problem with shipping if shipped from the retailer.
- If there is a problem with the price.

# Contact Information

If you have any questions, comments or need technical assistance contact our customer service department by calling (800) 248-0892, Monday through Friday. For calls from outside the USA or Canada, our local number is (517) 322-2144.

For inquiries by mail, our address is PO Box 80167, Lansing, MI 48908-0167. Our shipping address for returns is 2727 Snow Road, Lansing, MI 48917.

You may also contact us anytime by e-mail at [sales@airliftcompany.com](mailto:sales@airliftcompany.com) or on the web at [www.airliftcompany.com](http://www.airliftcompany.com).

# Electrical Schematic

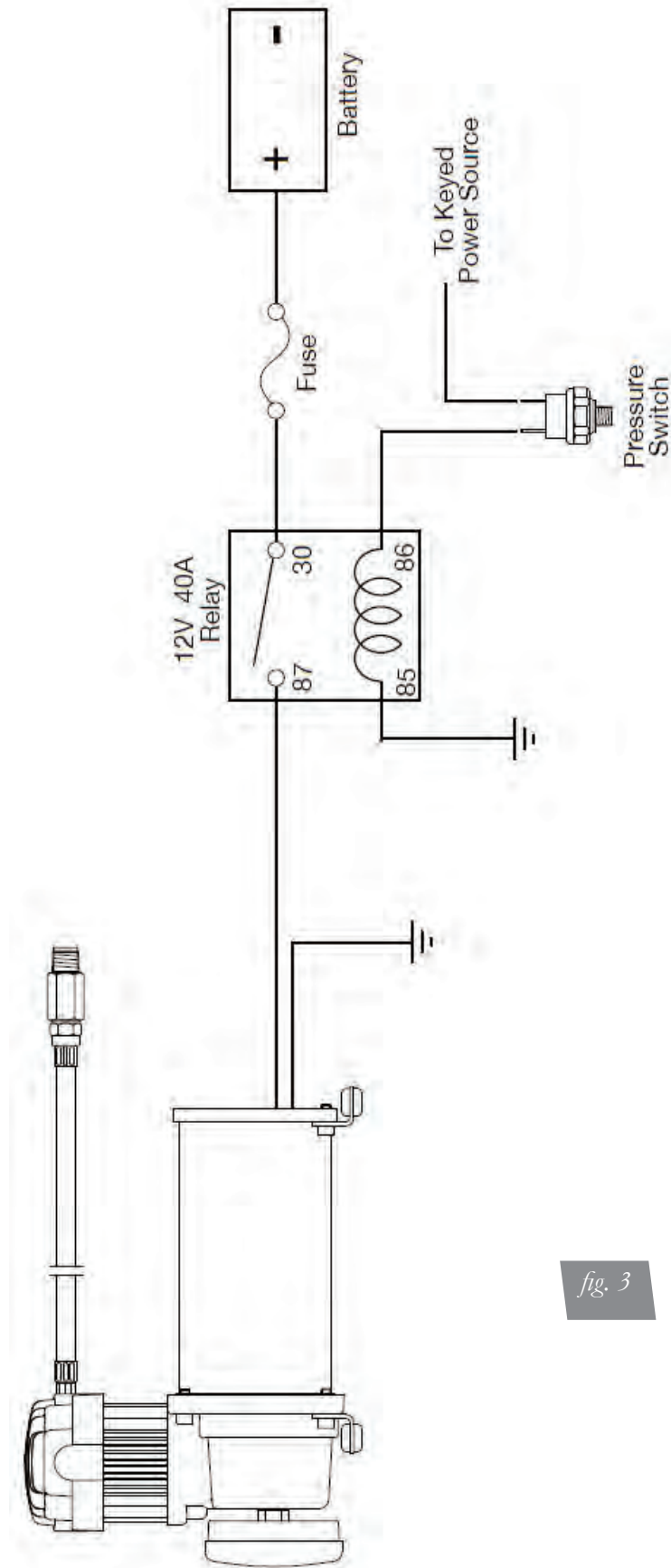
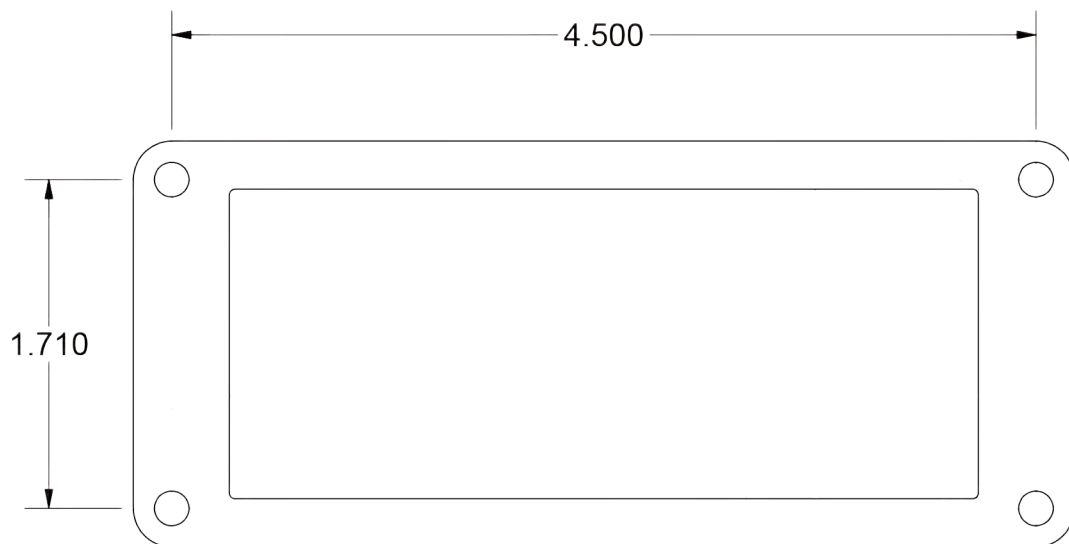

fig. 3

# Paddle Switch Mounting Bracket Template





# 16380 Compressor Template

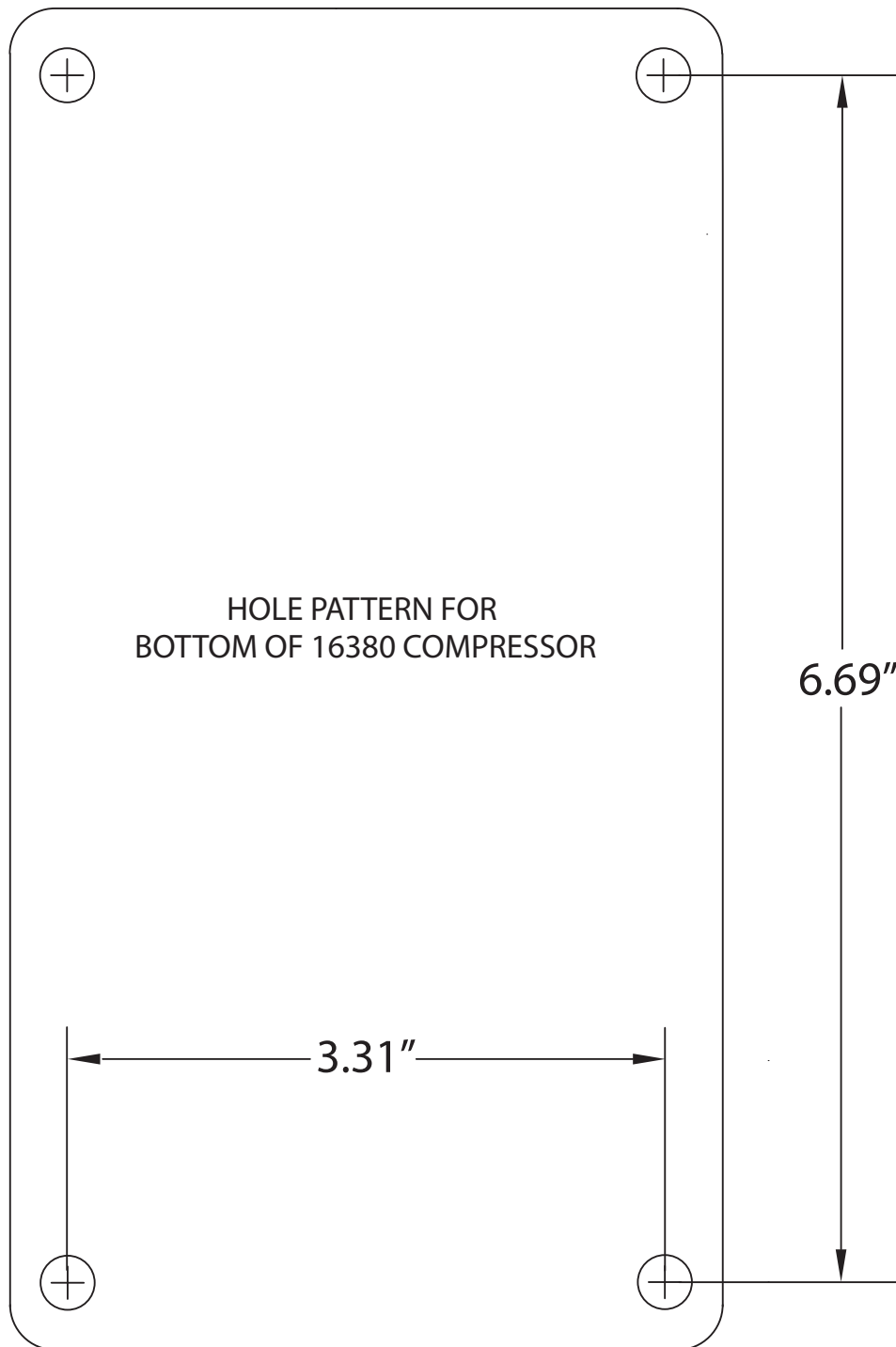







## Need Help?

Contact our customer service department by calling (800) 248-0892, Monday through Friday. For calls from outside the USA or Canada, our local number is (517) 322-2144.



*Thank you for purchasing Air Lift Performance products!*

Air Lift Performance • 2727 Snow Road • Lansing, MI 48917 or PO Box 80167 • Lansing, MI 48908-0167  
Toll Free (800) 248-0892 • Local (517) 322-2144 • Fax (517) 322-0240 • [www.airliftperformance.com](http://www.airliftperformance.com)

Printed in  
the USA