

Air Lift[™]
PERFORMANCE

Kit 78518
Nissan R35 GT-R
Front Application



INSTALLATION GUIDE

For maximum effectiveness and safety, please read these instructions completely before proceeding with installation.

Failure to read these instructions can result in an incorrect installation.

TABLE OF CONTENTS

| | |
|---|-----------|
| Introduction | 2 |
| Notation Explanation | 2 |
| Important Safety Notices | 2 |
| Installation Diagram | 3 |
| Hardware List | 3 |
| Installing the Air Suspension | 4 |
| Preparing the Vehicle | 4 |
| Removing the Front Suspension | 4 |
| Air Suspension Installation | 7 |
| Damping Adjustment | 12 |
| Aligning the Vehicle | 12 |
| Adjusting Extended or Drop Height Using Lower Mount | 13 |
| Before Operating | 15 |
| Installation Checklist | 15 |
| Post-Installation Checklist | 15 |
| Product Use, Maintenance and Servicing | 16 |
| Suggested Driving and Maximum Air Pressures | 16 |
| Maintaining and Operating | 16 |
| Troubleshooting Guide | 16 |
| Frequently Asked Questions | 16 |
| Tuning the Air Pressure | 17 |
| Checking for Leaks | 17 |
| Fixing Leaks | 17 |
| Warranty & Return Policy | 18 |
| Replacement Information | 18 |
| Contact Information | 18 |

Introduction



The purpose of this publication is to assist with the installation, maintenance and troubleshooting of this Nissan R35 GT-R Performance kit.

It is important to read and understand the entire installation guide before beginning installation or performing any maintenance, service or repair. The information includes a hardware list, step-by-step installation information, maintenance tips, safety information and a troubleshooting guide.

Air Lift Performance reserves the right to make changes and improvements to its products and publications at any time. For the latest version of this manual, contact Air Lift Performance at (800) 248-0892 or visit our website at www.airliftperformance.com.

NOTATION EXPLANATION

Hazard notations appear in various locations in this publication. Information which is highlighted by one of these notations must be observed to help minimize risk of personal injury or possible improper installation which may render the vehicle unsafe. Notes are used to help emphasize areas of procedural importance and provide helpful suggestions. The following definitions explain the use of these notations as they appear throughout this guide.

-  **DANGER** INDICATES IMMEDIATE HAZARDS WHICH WILL RESULT IN SEVERE PERSONAL INJURY OR DEATH.
-  **WARNING** INDICATES HAZARDS OR UNSAFE PRACTICES WHICH COULD RESULT IN SEVERE PERSONAL INJURY OR DEATH.
-  **CAUTION** INDICATES HAZARDS OR UNSAFE PRACTICES WHICH COULD RESULT IN DAMAGE TO THE MACHINE OR MINOR PERSONAL INJURY.



NOTE *Indicates a procedure, practice or hint which is important to highlight.*

IMPORTANT SAFETY NOTICES

The installation of this kit does not alter the Gross Vehicle Weight Rating (GVWR) or payload of the vehicle. Check your vehicle's owner's manual and do not exceed the maximum load listed for your vehicle.

Gross Vehicle Weight Rating: The maximum allowable weight of the fully loaded vehicle (including passengers and cargo). This number — along with other weight limits, as well as tire, rim size and inflation pressure data — is shown on the vehicle's Safety Compliance Certification Label.

Payload: The combined, maximum allowable weight of cargo and passengers that the vehicle is designed to carry. Payload is GVWR minus the Base Curb Weight.

-  **WARNING** DO NOT INFLATE AIR SPRINGS WHILE OFF OF THE VEHICLE. DAMAGE TO ASSEMBLY MAY RESULT AND VOID WARRANTY.
-  **CAUTION** DO NOT WELD TO, OR MODIFY PERFORMANCE STRUTS/SHOCKS IN ANY WAY. DAMAGE TO UNIT MAY OCCUR AND WILL VOID WARRANTY.

Installation Diagram

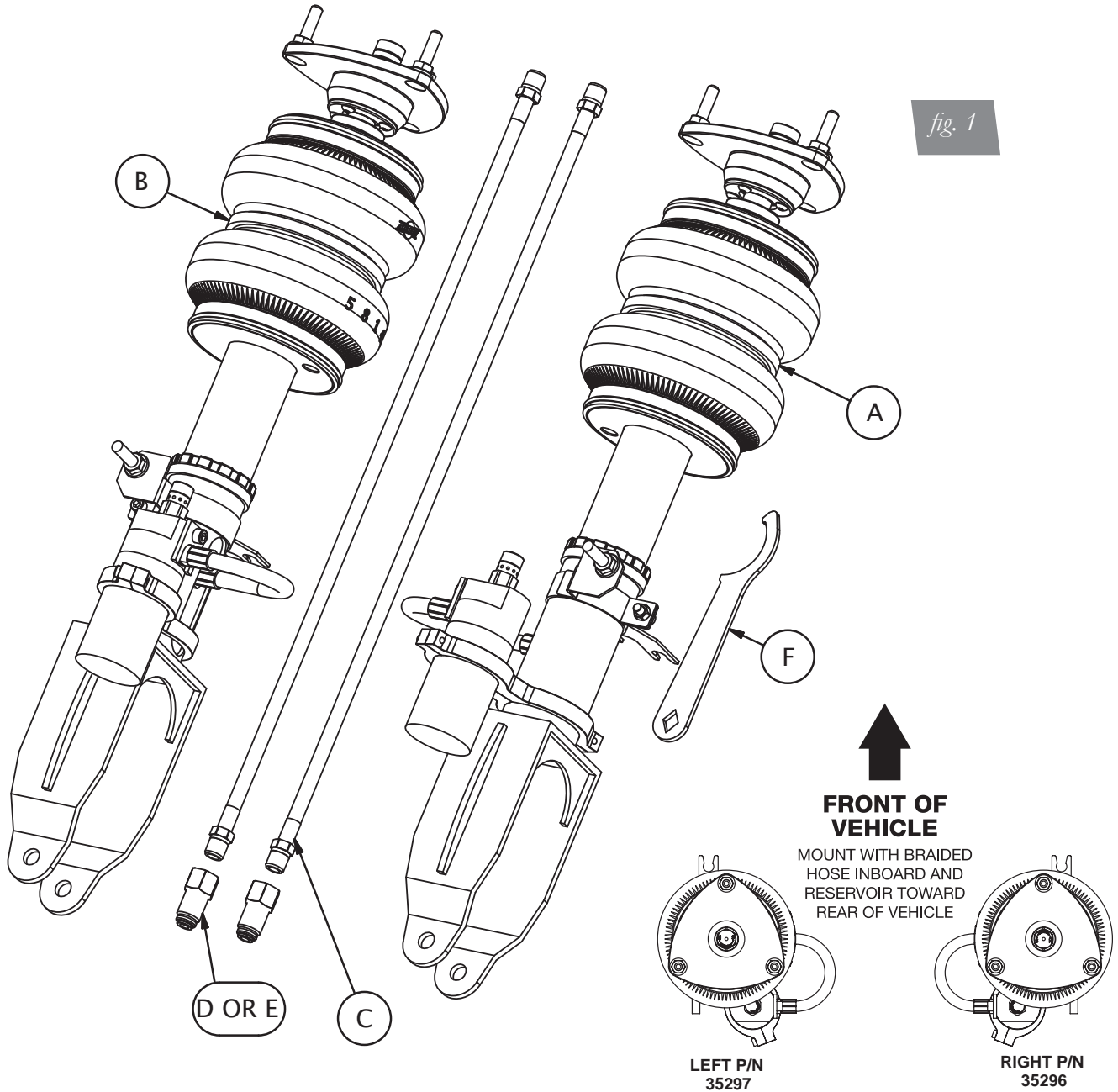

HARDWARE LIST

| Item | Part # | Description | Qty |
|------|--------|--|-----|
| A | 35296 | ASM, Shock, R-35 GT-R, RF | 1 |
| B | 35297 | ASM, Shock, R-35 GT-R, LF | 1 |
| C | 20997 | Leader Hose, 1/4" ID | 2 |
| D | 21987 | Union, 1/4" FNPT X 3/8" PTC, DOT | 2 |
| E | 21810 | Union, 1/4" FNPT X 1/4" PTC, DOT | 2 |
| F | | Spanner Wrench | 1 |



Missing or damaged parts? Call Air Lift customer service at (800) 248-0892 for a replacement part.

Installing the Air Suspension

PREPARING THE VEHICLE

1. Elevate and support the vehicle with a hoist or jack stands.
2. Remove the front tire and support the hub assembly (figs. 2 and 3).



fig. 2



fig. 3

REMOVING THE FRONT SUSPENSION

1. Remove the axle nut and loosen the axle in the hub (fig. 4).



fig. 4

2. Unclip the wheel sensor wire and brake line from the shock (figs. 5a-5e).



fig. 5a

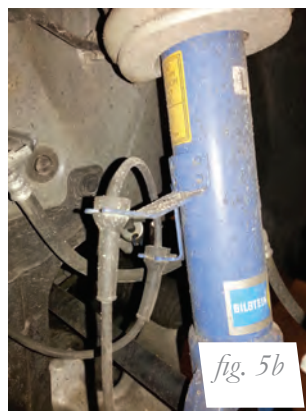

fig. 5b



fig. 5c



3. Loosen the forward pivot bolt for the lower control arm, but do not remove it (fig. 6).

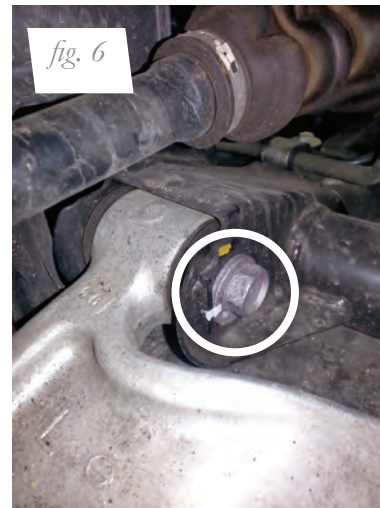

4. Support the hub and unbolt the lower shock mount from the control arm (fig. 7).



5. Disconnect the stabilizer end link from the lower control arm (fig. 8).



6. Support the hub and unbolt the steering knuckle from the upper control arm ball joint (figs. 9 and 10).



7. Within the engine compartment, locate the connection for the Electronic Damping Control and disconnect it (figs. 11 and 12).



8. With the EDC disconnected and the wire lead-free, unthread the three upper mount nuts and remove the shock from the vehicle (figs. 13 and 14).



AIR SUSPENSION INSTALLATION

1. Begin by installing the leader line into the air spring (fig. 15). Apply thread sealant to the threads of the leader hose. Tighten the appropriate fitting to the airline $1 \frac{3}{4}$ turns beyond hand-tight. Tighten the leader line into the air spring $1 \frac{3}{4}$ turns beyond hand-tight.

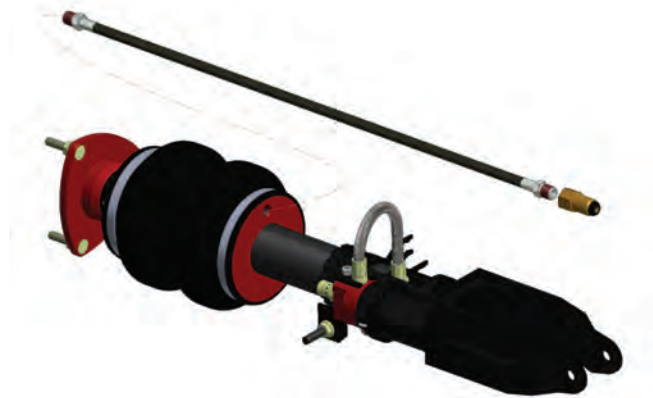

2. Remove the paper gasket from the factory shock upper mount and place onto the new shock assembly (fig. 16).



3. Insert the shock assembly so that the braided hose faces toward the engine compartment, and the external reservoir faces the rear of the vehicle (fig. 17). Torque upper mount nuts (fig. 18) to 27 Nm (20 ft-lbs.)

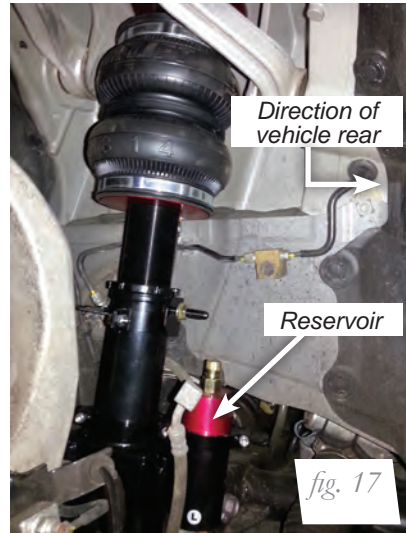

4. Reattach the upper control arm to the steering knuckle (fig. 19) and torque pinch bolt (fig. 20) to factory specification.



5. Lift the lower control arm up and reinstall the lower shock mount bolt (fig. 21). Do not torque at this time.



6. Align the stabilizer end link and insert it into the lower control arm (fig. 22). Torque to 100 Nm (74 ft-lbs.) (fig. 23).



- Attach the brake line to shock (fig. 24) and torque nut (fig. 25) to 13 Nm (10 ft-lbs.)



- Re-seat and torque the axle nut (fig. 26) to factory specifications.



- Cycle the suspension and check for clearances around the air spring. The air spring is quite close to the upper control arm attaching bolts (fig. 27). Sourcing a round head bolt may be required if contact with the air spring occurs.



10. Fully compress the suspension using a jack. With the suspension compressed, review the best routing for the leader hose that is clear of all suspension components and axle. Routing should also allow for the suspension to extend without kinking or pulling the line tight or rubbing on other components. Following the brake line routing is often a good place to start. Check clearances to all other components.
11. With the suspension fully compressed, take a measurement from the fender to some reference point – typically the center of the axle. Record this measurement as Max Compression.
12. Cycle the suspension to Max Extension and record the measurement from the same reference points.
13. Add ME and MC then divide by 2. Set the suspension to this point. This position will give 50% stroke in either direction and is a starting point for ride height (fig. 28).

Formula for Calculating Ride Height

$(ME+MC) \div 2 = \text{MID STROKE}$

fig. 28

14. With the suspension at this position, loosen, then re-torque the lower control arm bolts to manufacturer's specifications.

| Torque Specifications | | |
|--------------------------------------|---------------------------------|------------|
| Location | Nm | lb-ft |
| Lower shock mount bolt/nut | 107 | 79 |
| Lower control arm forward bolt | 100 | 74 |
| Swaybar endlink to lower control arm | 100 | 74 |
| Upper mount nut | 27 | 20 |
| Brake line attachment nut | 13 | 10 |
| Air Fitting (with sealant) | 1.5-3.0 turns beyond hand tight | |
| Lower damper locking collar | .5 turns beyond hand tight | |
| Reservoir collar bolts | 5 | 44 in-lbs. |
| Wheel studs | 131 | 97 |

Table 1

DAMPING ADJUSTMENT

There are two forms of damping adjustment with this Nissan R35 GT-R suspension kit.

Rebound adjustment is controlled by the adjuster on the shock rod, located within the engine compartment (fig. 29). Turn the damping knob clockwise to “harden” the suspension rebound. Turn the knob counterclockwise to “soften” the suspension rebound. The Air Lift setting is -17R (17 clicks away from full hard). This was developed on a 2009 GT-R and may need adjustment to meet vehicle differences or driving demands.



Compression damping is adjusted through the remote reservoir attached to the shock body (fig. 30). Turn the damping knob on the reservoir clockwise to “harden” the suspension compression setting. Turn the knob counterclockwise to “soften” the suspension compression setting. The Air Lift setting is -21C (21 clicks away from full hard). This was developed on a 2009 GT-R and may need adjustment to meet vehicle differences or driving demands.

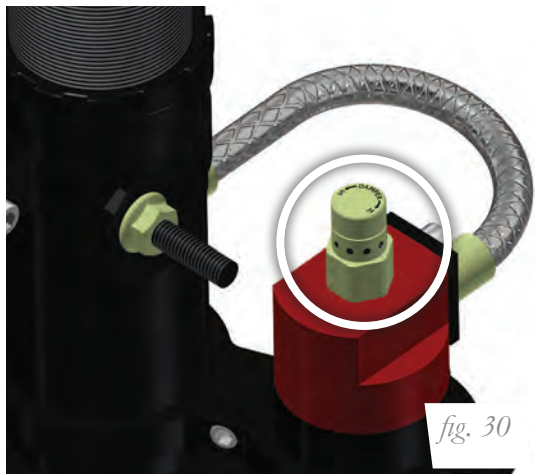

ALIGNING THE VEHICLE

1. Using the control system, set the vehicle height to the new custom ride height.
2. If the custom ride height is lower than stock, we recommend loosening all pivot points (bolts, nuts) on any control arm, strut arm or radius rod that contains bushings. Once they have been loosened, re-torque to stock specifications.

NOTE

It may be necessary to cycle the suspension to loosen the bushing up from its mount. This will help re-orient the bushing at its new position and increase life of the bushings based on the custom ride height.

ADJUSTING EXTENDED OR DROP HEIGHT USING LOWER MOUNT

Your struts have been pre-set at the factory to provide maximum drop height while maintaining adequate tire clearance to the air spring. If you wish to gain more extended height (lift), which is the same as reducing drop height, or want to lower the chassis further and there is still adjustment available at the lower mount, please use the following procedure:

1. Support the vehicle with jack stands or a hoist at approved lifting points.
2. Remove the wheel.
3. Using the supplied spanner wrench, loosen the lower locking collar (fig. 31).

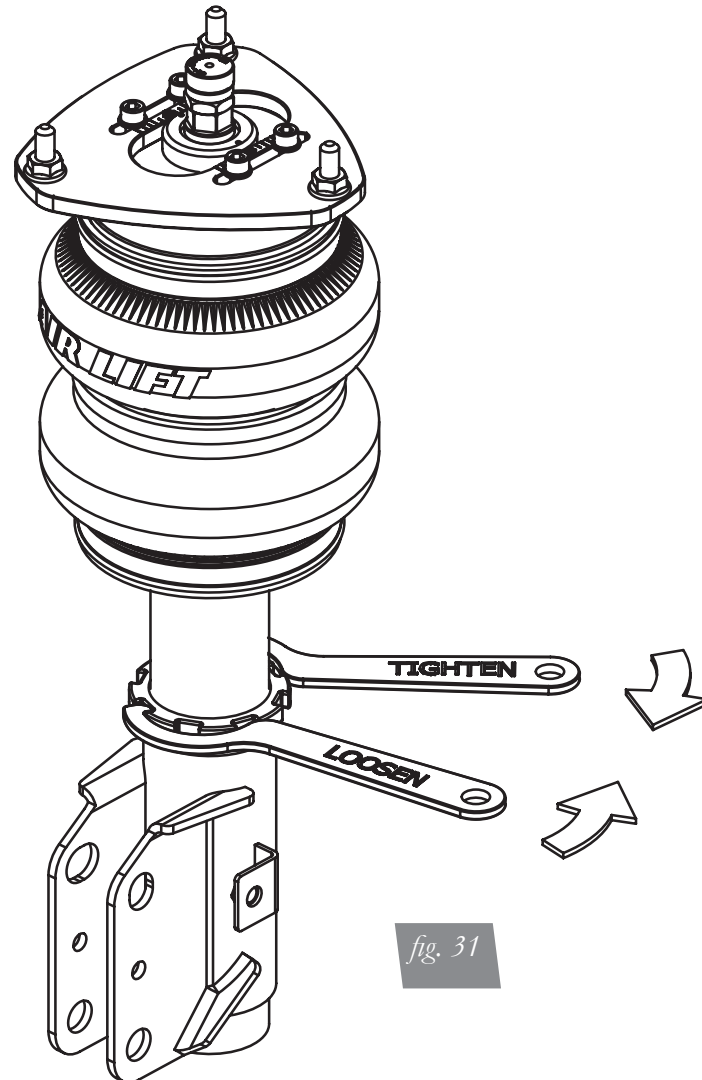

4. Deflate the air spring to 0 PSI on the corner you are adjusting.
5. Disconnect lower mount from suspension.
6. Spin the lower mount to the desired location.

NOTE

Not all models will have further drop height available.

7. Re-install lower mount to suspension and torque fasteners.
8. Tighten the lower locking collar to the lower mount using significant force.

CAUTION

WHEN ADJUSTING HEIGHT UPWARDS, MAKE SURE THAT THE STRUT BODY ENGAGES ALL THE THREADS OF THE LOWER MOUNT (FIG. 32). WHEN ADJUSTING DOWNWARDS, MAKE SURE THERE IS ADEQUATE AIR SPRING CLEARANCE TO THE TIRE/WHEEL ASSEMBLY. CLEARANCE MUST BE CHECKED WITH SYSTEM FULLY DEFLATED AS WELL AS FULLY INFLATED TO ENSURE THAT NO RUBBING OCCURS. FAILURE TO MAINTAIN ADEQUATE CLEARANCE CAN RESULT IN AIR SPRING FAILURE AND WILL NOT BE COVERED UNDER WARRANTY.

CAUTION

DO NOT ADJUST HEIGHT BY SPINNING THE AIR SPRING ON THE STRUT! DOING SO MAY CAUSE AN AIR LEAK AND COMPROMISE THE ASSEMBLY.

FOR STRUTS:

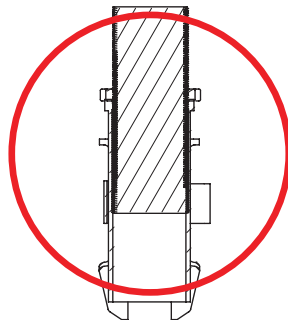
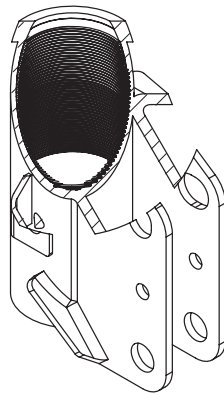

OK, no threads showing.

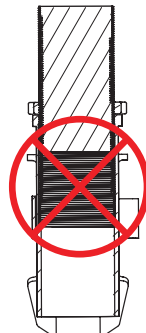

Not OK, threads are showing.

FOR SHOCKS:

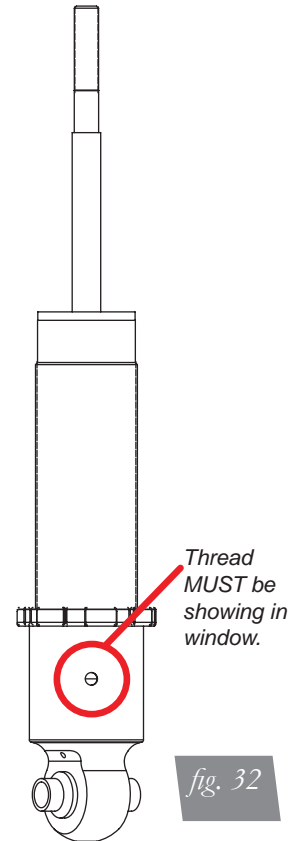

Before Operating

CAUTION

MAKE SURE THE FRONT WHEELS ARE STRAIGHT WHEN DEFLATING AND REINFLATING AIR BAGS.

1. Inflate and deflate the system (do not exceed 125 PSI) to check for clearance or binding issues. With the air springs deflated, check clearances on everything so as not to pinch brake lines, vent tubes, etc. Clear lines if necessary.
2. Inflate the air springs to 75-90 PSI and check all connections for leaks.
3. Air Lift part #27669 or #27671, AutoPilot V2 Air Management System, is highly recommended for this product.
4. Please familiarize yourself further with this product by reading the Product Use, Maintenance and Servicing section.

INSTALLATION CHECKLIST

- Clearance test — Inflate the air springs to 75-90 PSI and make sure there is at least 1/2" clearance from anything that might rub against each sleeve. Be sure to check the tire, brake drum, frame, shock absorbers and brake cables.
- Leak test before road test — Inflate the air springs to 75-90 PSI and check all connections for leaks. All leaks must be eliminated before the vehicle is road tested.
- Heat test — Be sure there is sufficient clearance from heat sources, at least 6" for air springs and air lines. If a heat shield was included in the kit, install it. If there is no heat shield, but one is required, call Air Lift customer service at (800) 248-0892.
- Fastener test — Recheck all bolts for proper torque.
- Road test — The vehicle should be road tested after the preceding tests. Inflate the springs to recommended driving pressures. Drive the vehicle 10 miles and recheck for clearance, loose fasteners and air leaks.
- Operating instructions — If professionally installed, the installer should review the operating instructions with the owner. Be sure to provide the owner with all of the paperwork that came with the kit.

Technician's Signature _____

Date _____

POST-INSTALLATION CHECKLIST

- Overnight leak down test — Recheck air pressure after the vehicle has been used for 24 hours. If the pressure has dropped more than 5 PSI, then there is a leak that must be fixed. Either fix the leak yourself or return to the installer for service.
- Air pressure requirements — Regardless of load, the air pressure should always be adjusted to maintain adequate ride height at all times while driving.
- Thirty day or 500 mile test — Recheck the air spring system after 30 days or 500 miles, whichever comes first. If any part shows signs of rubbing or abrasion, the source should be identified and moved, if possible. If it is not possible to relocate the cause of the abrasion, the air spring may need to be remounted. If professionally installed, the installer should be consulted. Check all fasteners for tightness.

Product Use, Maintenance and Servicing

| Suggested Driving Air Pressure | Maximum Air Pressure |
|---|----------------------|
| 70 PSI | 125 PSI |
| FAILURE TO MAINTAIN ADEQUATE MINIMUM PRESSURE (OR PRESSURE PROPORTIONAL TO LOAD) WILL RESULT IN BOTTOMING OUT, OVER-EXTENSION OR RUBBING AGAINST ANOTHER COMPONENT AND WILL VOID THE WARRANTY. | |

MAINTENANCE GUIDELINES

NOTE

By following these steps, vehicle owners will obtain the longest life and best results from their air spring.

1. Check the air pressure before driving.
2. Never inflate beyond 125 PSI.
3. If you develop an air leak in the system, use a soapy water solution to check all air line connections, before deflating and removing the spring.
4. When increasing load, always adjust the air pressure to maintain normal ride height. Increase or decrease pressure from the system as necessary to attain normal ride height for optimal ride and handling. Remember that loads carried behind the axle (including tongue loads) require more leveling force (pressure) than those carried directly over the axle.

CAUTION

FOR YOUR SAFETY AND TO PREVENT DAMAGE TO YOUR VEHICLE, DO NOT EXCEED MAXIMUM GROSS VEHICLE WEIGHT RATING (GVWR), AS INDICATED BY THE VEHICLE MANUFACTURER. ALTHOUGH YOUR AIR SPRINGS ARE RATED AT A MAXIMUM INFLATION PRESSURE OF 125 PSI, THE AIR PRESSURE ACTUALLY NEEDED IS DEPENDENT ON YOUR LOAD.

5. Always add air to the springs in small quantities, checking the pressure frequently. Sleeves require less air volume than a tire and inflate quickly.
6. Should it become necessary to raise the vehicle by the frame, make sure the control system is turned off before lifting.

Troubleshooting Guide

1. Leak test the air line connections, the threaded connection into the air spring, and all fittings in the control system.
2. Inspect the air lines to be sure none are pinched. Tie straps may be too tight. Loosen or replace the strap and replace leaking components.
3. Inspect the air line for holes and cracks. Replace as needed.
4. Look for a kink or fold in the air line. Reroute as needed.

If the preceding steps do not solve the problem, it is possibly caused by a failed air spring — either a factory defect or an operating problem. Please call Air Lift at (800) 248-0892 for assistance.

Frequently Asked Questions

Q. Will installing air springs increase the weight ratings of a vehicle?

No. Adding air springs will not change the weight ratings (GAWR, GCWR and/or GVWR) of a vehicle. Exceeding the GVWR is dangerous and voids the Air Lift warranty.

Q. How long should air springs last?

If the air springs are properly installed and maintained they can last indefinitely.

Q. Will raising the vehicle on a hoist for service work damage the air springs?

No. The vehicle can be lifted on a hoist for short-term service work such as tire rotation or oil changes. However, if the vehicle will be on the hoist for a prolonged period of time, support the axle with jack stands in order to take the tension off of the air springs.

Tuning the Air Pressure

Pressure determination comes down to three things — level vehicle, ride comfort, and stability.

1. Level vehicle

If the vehicle's headlights are shining into the trees or the vehicle is leaning to one side, then it is not level. Raise the air pressure to correct either of these problems and level the vehicle.

2. Ride comfort

If the vehicle has a rough or harsh ride it may be due to either too much pressure or not enough. Try different pressures to determine the best ride comfort. See Air Lift suggested driving air pressure.

3. Stability

Stability translates into safety and should be the priority, meaning the driver may need to sacrifice a perfectly level and comfortable ride. Stability issues include roll control, bounce, dive during braking and sponginess. Tuning out these problems usually requires additional air pressure, strut damping, or both.

Checking for leaks

1. Inflate the air spring to 80 PSI.
2. Spray all connections and the inflation valves with a solution of 1/5 liquid dish soap and 4/5 water. Spot leaks easily by looking for bubbles in the soapy water.
3. After the test, deflate the springs to the minimum pressure required to restore the system to normal ride height.
4. Check the air pressure again after 24 hours. A 2-4 PSI loss after initial installation is normal. Retest for leaks if the loss is more than 5 PSI.

Fixing Leaks

1. If there is a problem with a swivel fitting:
 - a. Check the air line connection by deflating the spring and removing the line by pulling the collar against the fitting and pulling firmly on the air line. Trim 1" off the end of the air line. Be sure the cut is clean and square (see fig. 33). Reinsert the air line into the push-to-connect fitting.
 - b. Check the threaded connection by tightening the swivel fitting another ½ turn. If it still leaks, deflate the air spring, remove the fitting, and re-coat the threads with thread sealant. Reinstall by hand tightening as much as possible and then use a wrench for an additional two turns.
2. If the preceding steps have not resolved the problem, call Air Lift customer service at (800) 248-0892.

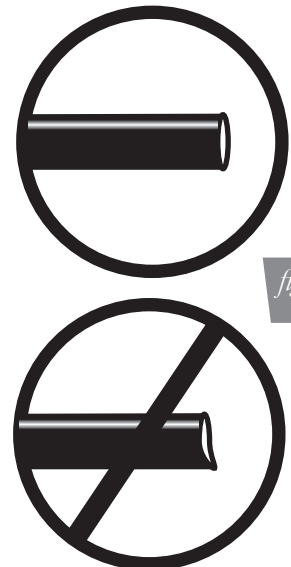

fig. 33

Warranty and Returns Policy

Air Lift Performance warrants its performance products for one year to the original purchaser against manufacturing defects one year from the date of purchase when used on cars and trucks as specified under normal operating conditions. The warranty does not apply to products that have been improperly applied, improperly installed, or which have not been maintained in accordance with installation instructions furnished with all products. The consumer will be responsible for removing (labor charges) the defective product from the vehicle and returning it, transportation costs prepaid, to the dealer from which it was purchased or to Air Lift Performance for verification.

Air Lift will repair or replace, at its option, defective products or components. A minimum \$10.00 shipping and handling charge will apply to all warranty claims. Before returning any defective product, you must call Air Lift at (800) 248-0892 in the U.S. and Canada (elsewhere, (517) 322-2144) for a Returned Materials Authorization (RMA) number. Returns to Air Lift can be sent to: Air Lift Performance • 2727 Snow Road • Lansing, MI • 48917.

Product failures resulting from abnormal use or misuse are excluded from this warranty. The loss of use of the product, loss of time, inconvenience, commercial loss or consequential damages is not covered. The consumer is responsible for installation/reinstallation (labor charges) of the product. Air Lift Performance reserves the right to change the design of any product without assuming any obligation to modify any product previously manufactured.

This warranty gives you specific legal rights and you may also have other rights that may vary from state-to-state. Some states do not allow limitations on how long an implied warranty lasts or allow the exclusion or limitation of incidental or consequential damages. The above limitation or exclusion may not apply to you. There are no warranties, expressed or implied including any implied warranties of merchantability and fitness, which extend beyond this warranty period. There are no warranties that extend beyond the description on the face hereof. Seller disclaims the implied warranty of merchantability. (Dated proof of purchase required.)

Replacement Information

If you need replacement parts, contact the local dealer or call Air Lift customer service at (800) 248-0892. Most parts are immediately available and can be shipped the same day.

Contact Air Lift Performance customer service at (800) 248-0892 first if:

- Parts are missing from the kit.
- Need technical assistance on installation or operation.
- Broken or defective parts in the kit.
- Wrong parts in the kit.
- Have a warranty claim or question.

Contact the retailer where the kit was purchased:

- If it is necessary to return or exchange the kit for any reason.
- If there is a problem with shipping if shipped from the retailer.
- If there is a problem with the price.

Contact Information

If you have any questions, comments or need technical assistance contact our customer service department by calling (800) 248-0892. For calls from outside the USA or Canada, our local number is (517) 322-2144. You may also contact customer service anytime by e-mail at techsupport@airliftperformance.com.

For inquiries by mail, our address is PO Box 80167, Lansing, MI 48908-0167. Our shipping address for returns is 2727 Snow Road, Lansing, MI 48917.

You may also contact our sales team anytime by e-mail at sales@airliftperformance.com or on the web at www.airliftperformance.com.

Notes

Notes

Notes

Need Help?

Contact our customer service department by calling (800) 248-0892. For calls from outside the USA or Canada, our local number is (517) 322-2144.



Thank you for purchasing Air Lift Performance products!

Air Lift Performance • 2727 Snow Road • Lansing, MI 48917 or PO Box 80167 • Lansing, MI 48908-0167
Toll Free (800) 248-0892 • Local (517) 322-2144 • Fax (517) 322-0240 • www.airliftperformance.com

Printed in
the USA

Air Lift™

PERFORMANCE

Kit 78618

Nissan R35 GT-R

Rear Application



INSTALLATION GUIDE

For maximum effectiveness and safety, please read these instructions completely before proceeding with installation.

Failure to read these instructions can result in an incorrect installation.

TABLE OF CONTENTS

| | |
|---|-----------|
| Introduction | 2 |
| Notation Explanation | 2 |
| Important Safety Notices | 2 |
| Installation Diagram | 3 |
| Hardware List | 3 |
| Installing the Air Suspension | 4 |
| Preparing the Vehicle | 4 |
| Removing the Rear Suspension | 8 |
| Air Suspension Installation | 9 |
| Damping Adjustment | 12 |
| Threaded Height Adjustment | 13 |
| Aligning the Vehicle | 13 |
| Before Operating | 15 |
| Installation Checklist | 15 |
| Post-Installation Checklist | 15 |
| Product Use, Maintenance and Servicing | 16 |
| Suggested Driving and Maximum Air Pressures | 16 |
| Maintaining and Operating | 16 |
| Troubleshooting Guide | 16 |
| Frequently Asked Questions | 16 |
| Tuning the Air Pressure | 17 |
| Checking for Leaks | 17 |
| Fixing Leaks | 17 |
| Warranty & Return Policy | 18 |
| Replacement Information | 18 |
| Contact Information | 18 |

Introduction

The purpose of this publication is to assist with the installation, maintenance and troubleshooting of this Nissan R35 GT-R Performance kit.

It is important to read and understand the entire installation guide before beginning installation or performing any maintenance, service or repair. The information includes a hardware list, step-by-step installation information, maintenance tips, safety information and a troubleshooting guide.

Air Lift Performance reserves the right to make changes and improvements to its products and publications at any time. For the latest version of this manual, contact Air Lift Performance at (800) 248-0892 or visit our website at www.airliftperformance.com.

NOTATION EXPLANATION

Hazard notations appear in various locations in this publication. Information which is highlighted by one of these notations must be observed to help minimize risk of personal injury or possible improper installation which may render the vehicle unsafe. Notes are used to help emphasize areas of procedural importance and provide helpful suggestions. The following definitions explain the use of these notations as they appear throughout this guide.

DANGER

INDICATES IMMEDIATE HAZARDS WHICH WILL RESULT IN SEVERE PERSONAL INJURY OR DEATH.

WARNING

INDICATES HAZARDS OR UNSAFE PRACTICES WHICH COULD RESULT IN SEVERE PERSONAL INJURY OR DEATH.

CAUTION

INDICATES HAZARDS OR UNSAFE PRACTICES WHICH COULD RESULT IN DAMAGE TO THE MACHINE OR MINOR PERSONAL INJURY.

NOTE

Indicates a procedure, practice or hint which is important to highlight.

IMPORTANT SAFETY NOTICES

The installation of this kit does not alter the Gross Vehicle Weight Rating (GVWR) or payload of the vehicle. Check your vehicle's owner's manual and do not exceed the maximum load listed for your vehicle.

Gross Vehicle Weight Rating: The maximum allowable weight of the fully loaded vehicle (including passengers and cargo). This number — along with other weight limits, as well as tire, rim size and inflation pressure data — is shown on the vehicle's Safety Compliance Certification Label.

Payload: The combined, maximum allowable weight of cargo and passengers that the vehicle is designed to carry. Payload is GVWR minus the Base Curb Weight.

WARNING

DO NOT INFLATE AIR SPRINGS WHILE OFF OF THE VEHICLE. DAMAGE TO ASSEMBLY MAY RESULT AND VOID WARRANTY.

CAUTION

DO NOT WELD TO, OR MODIFY PERFORMANCE STRUTS/SHOCKS IN ANY WAY. DAMAGE TO UNIT MAY OCCUR AND WILL VOID WARRANTY.

Installation Diagram

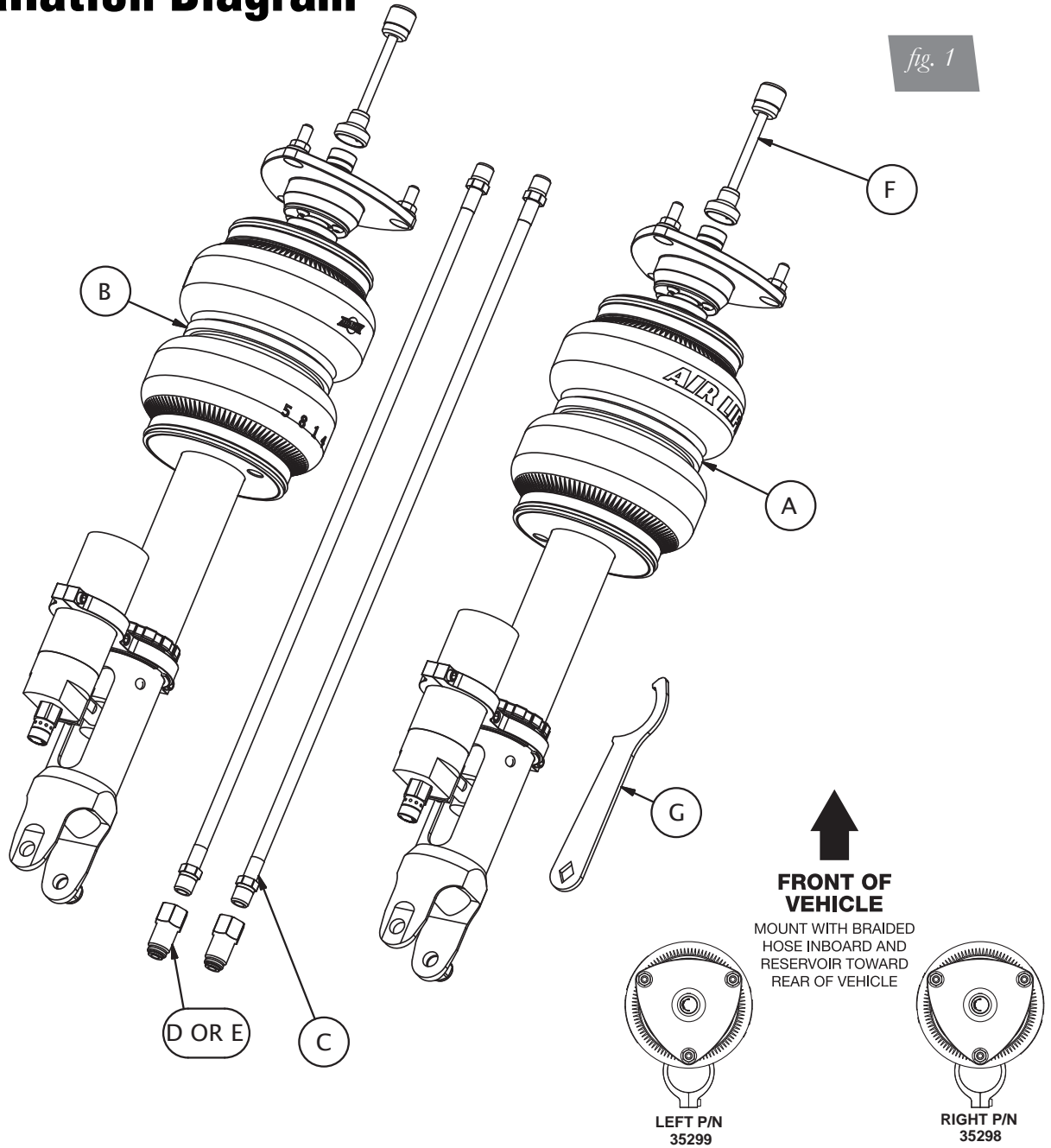

HARDWARE LIST

| Item | Part # | Description | Qty |
|------|--------|---------------------------------------|-----|
| A | 35298 | ASM, Shock, R-35 GT-R, RR..... | 1 |
| B | 35299 | ASM, Shock, R-35 GT-R, LR..... | 1 |
| C | 20997 | Leader Hose, 1/4" ID | 2 |
| D | 21810 | Union, 1/4"FNPT X 1/4" PTC, DOT | 2 |
| E | 21987 | Union, 1/4"FNPT X 3/8" PTC, DOT | 2 |
| F | | Flexible Adjuster Extension | 2 |
| G | | Spanner Wrench..... | 1 |



Missing or damaged parts? Call Air Lift customer service at (800) 248-0892 for a replacement part.

Installing the Air Suspension

PREPARING THE VEHICLE

1. Unclip the rear seat bases and remove the bases from the vehicle (fig. 2).

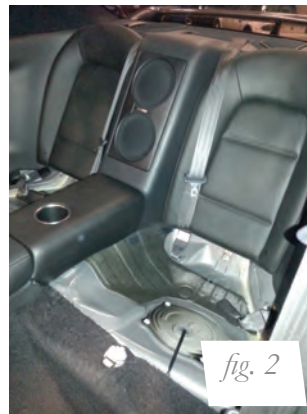

2. At the base of each rear seat back, remove the bolt shown in Figure 3, then push upward on the seat back. Remove both seat backs this way (figs. 4 and 5).

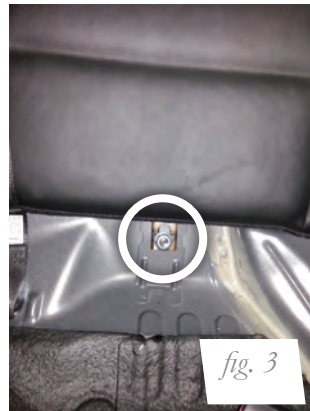

3. Unclip and remove the center cup holder between the rear seat locations.
4. Unbolt the two bolts at the base of the rear center speaker cover (fig. 6). With the two lower bolts removed, carefully unclip the speaker cover from the rear support and remove from the vehicle (fig. 7).



5. Remove both side sills (figs. 8 and 9).

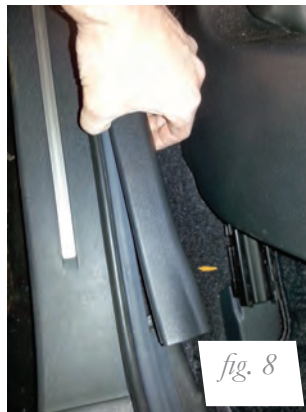

6. Remove the weather-stripping from the rear most portion of the door opening (fig 10).

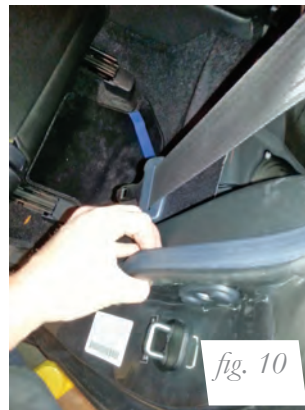

- Unclip the rear side panel from the rear support and side (figs. 11 and 12). Remove it from the vehicle (fig. 13).



- Remove the upper side trim by unthreading the screw beneath the hanger, unbolting the seat belt from the pillar and unclipping the remaining plastic retention clips (figs. 14a-14i).





9. Remove all the plastic screws holding the rear parcel shelf (figs. 15-17) and pull the shelf straight forward, then down (fig. 18).



10. Disconnect the Electronic Damping Control on each rear shock (figs. 19 and 20). This may be located beneath a foil shield with an adhesive backing (fig 21); remove it if necessary.

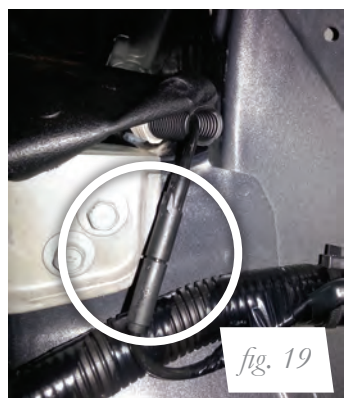

REMOVING THE REAR SUSPENSION

1. Elevate and support the vehicle with a hoist or jack stands (fig. 22).

fig. 22

2. Remove the rear wheel and support the hub assembly (fig. 23).

fig. 23

3. Remove the three upper shock mount nuts (fig. 24).

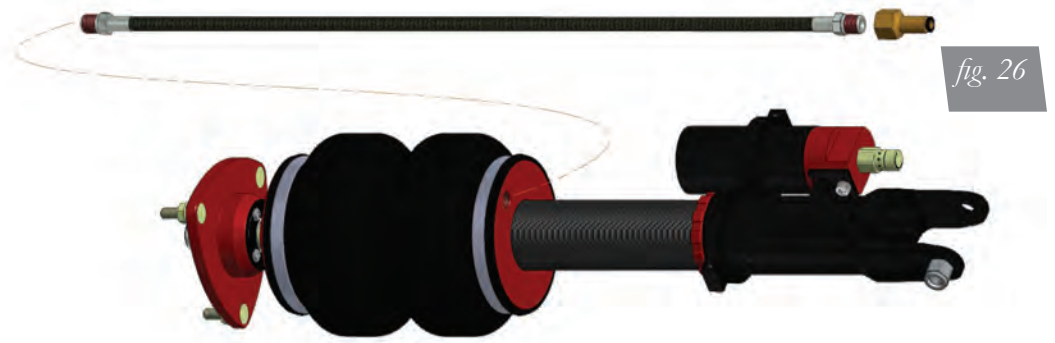

fig. 24

4. Remove the lower shock bolt and extract the stock rear shock assembly (fig. 25) from the vehicle.



5. AIR SUSPENSION INSTALLATION

1. Begin by installing the leader line into the air spring (fig. 26). Apply thread sealant to the threads of the leader hose. Tighten the appropriate fitting to the airline 1 3/4 turns beyond hand-tight. Tighten the leader line into the air spring 1 3/4 turns beyond hand-tight.



2. Remove the paper gasket from the factory shock upper mount and place onto the new shock assembly (fig. 27).



3. Add the damping adjuster flexible adjuster extension (fig. 28) to the top of the shock. Ensure the main damping adjuster knob is tight on the shock rod before sliding adjuster extension over knob and tightening set screw.

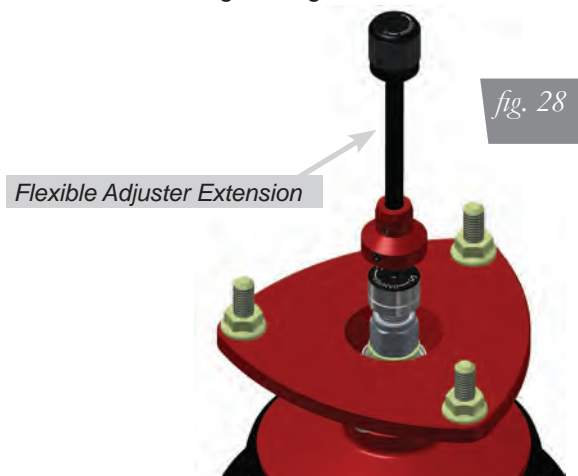

4. Attach the shock assembly to the shock tower with the three upper mount nuts. The external reservoir should be directed toward the rear of the vehicle and braided air line inboard (figs. 29 and 30). Torque to 27 Nm (20 ft-lbs.)

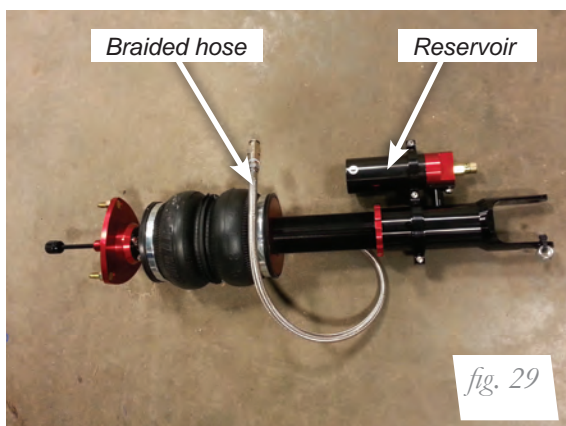

5. Lift the hub assembly and install the lower shock mount bolt (fig. 31). Do not torque at this time.



6. Alter the rear parcel shelf so that the flexible damping adjuster can be accessible from within the vehicle cabin.
7. Reinstall the interior by reversing the steps 1-9 of Preparing the Vehicle.
8. With the suspension fully compressed, take a measurement from the fender to some reference point – typically the center of the axle. Record this measurement as Max Compression.
9. Cycle the suspension to Max Extension and record the measurement from the same reference points.
10. Add ME and MC then divide by 2. Set the suspension to this point. This position will give 50% stroke in either direction and is a starting point for ride height (fig. 32).

Formula for Calculating Ride Height

$(ME+MC) \div 2 = \text{MID STROKE}$

fig. 32

11. With the suspension at this position, loosen, then re-torque the lower control arm bolts to manufacturer’s specifications.

| Torque Specifications | | |
|-----------------------------|---------------------------------|------------|
| Location | Nm | lb-ft |
| Lower shock mount bolt/nut | 75 | 55 |
| Upper mount nut | 27 | 20 |
| Air Fitting (with sealant) | 1.5-3.0 turns beyond hand tight | |
| Lower damper locking collar | .5 turns beyond hand tight | |
| Reservoir collar bolts | 5 | 44 in-lbs. |
| Wheel studs | 131 | 97 |

Table 1

DAMPING ADJUSTMENT

There are two forms of damping adjustment with this Nissan R35 GT-R suspension kit.

Rebound adjustment is controlled by the adjuster on the shock rod, located within the passenger compartment (fig. 33). Turn the damping knob clockwise to “harden” the suspension rebound. Turn the knob counterclockwise to “soften” the suspension rebound. The Air Lift setting is -13R (13 clicks away from full Hard). This was developed on a 2009 GT-R and may need adjustment to meet vehicle differences or driving demands.



Compression damping is adjusted through the remote reservoir attached to the shock body. Turn the damping knob on the reservoir (fig. 34) clockwise to “harden” the suspension compression setting. Turn the knob counterclockwise to “soften” the suspension compression setting. The Air Lift setting is -18C (18 clicks away from full hard). This was developed on a 2009 GT-R and may need adjustment to meet vehicle differences or driving demands.



THREADED HEIGHT ADJUSTMENT

The shock assembly can be adjusted by threading the damper cartridge in or out of the lower mount. To do this, the collar holding the external reservoir must be loosened first!

CAUTION

FAILURE TO LOOSEN THE THREE ATTACHING BOLTS (FIG. 35) OF THE RESERVOIR COLLAR CAN RESULT IN THE ATTACHING TUBE TO DETACH OR BECOME SIDE-LOADED, CAUSING A LEAK OR PREMATURE FAILURE OF THE DAMPER.

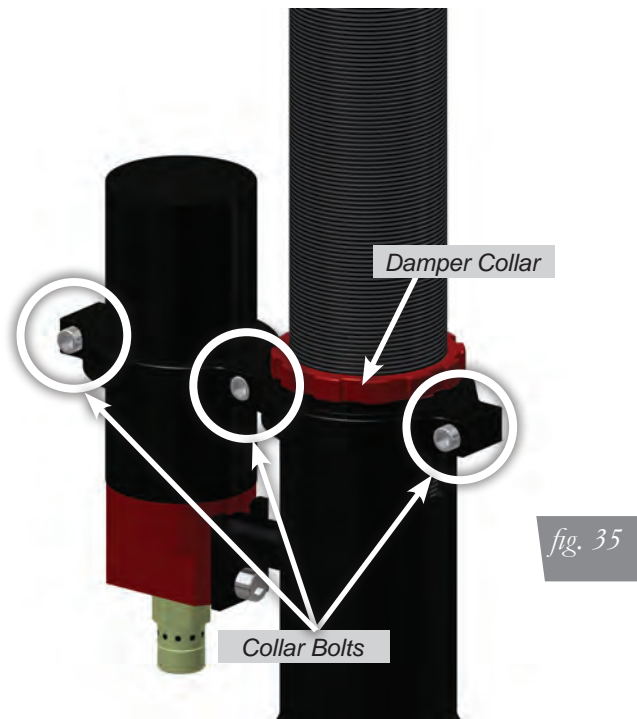

1. Loosen the three reservoir collar bolts.
2. Loosen the damper collar.
3. Make the threaded height adjustment.
4. Tighten the damper collar 1/2 turn beyond hand-tight.
5. Tighten the reservoir collar bolts evenly to 5 Nm (44 in-lbs.)

ALIGNING THE VEHICLE

1. Using the control system, set the vehicle height to the new custom ride height.
2. If the custom ride height is lower than stock, we recommend loosening all pivot points (bolts, nuts) on any control arm, strut arm or radius rod that contains bushings. Once they have been loosened, re-torque to stock specifications.

NOTE

It may be necessary to cycle the suspension to loosen the bushing up from its mount. This will help re-orient the bushing at its new position and increase life of the bushings based on the custom ride height.

CAUTION

WHEN ADJUSTING HEIGHT UPWARDS, MAKE SURE THAT THE STRUT BODY ENGAGES ALL THE THREADS OF THE LOWER MOUNT (FIG. 36). WHEN ADJUSTING DOWNWARDS, MAKE SURE THERE IS ADEQUATE AIR SPRING CLEARANCE TO THE TIRE/WHEEL ASSEMBLY. CLEARANCE MUST BE CHECKED WITH SYSTEM FULLY DEFLATED AS WELL AS FULLY INFLATED TO ENSURE THAT NO RUBBING OCCURS. FAILURE TO MAINTAIN ADEQUATE CLEARANCE CAN RESULT IN AIR SPRING FAILURE AND WILL NOT BE COVERED UNDER WARRANTY.

CAUTION

DO NOT ADJUST HEIGHT BY SPINNING AIR SPRING ON STRUT! DOING SO MAY CAUSE AN AIR LEAK AND COMPROMISE THE ASSEMBLY.

FOR STRUTS:

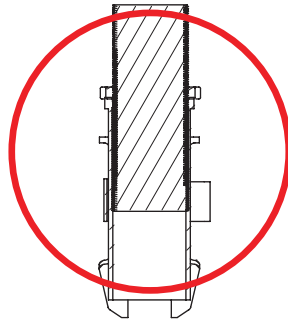
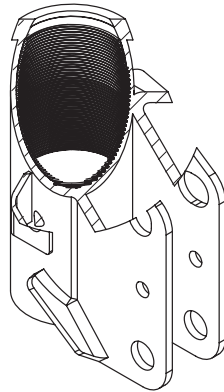

OK, no threads showing.

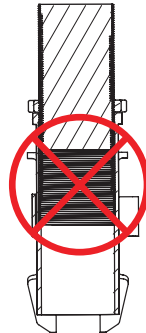

Not OK, threads are showing.

FOR SHOCKS:

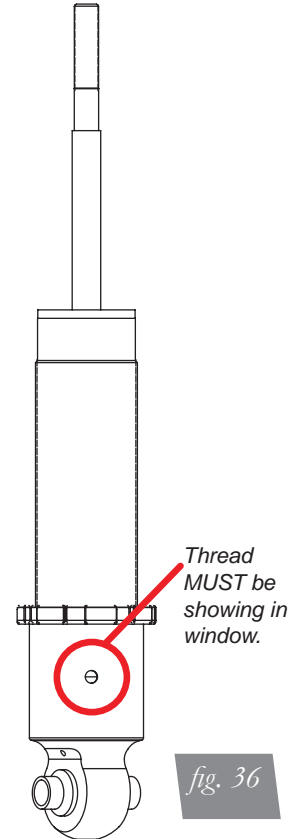

Before Operating

CAUTION

MAKE SURE THE FRONT WHEELS ARE STRAIGHT WHEN DEFLATING AND REINFLATING AIR BAGS.

1. Inflate and deflate the system (do not exceed 125 PSI) to check for clearance or binding issues. With the air springs deflated, check clearances on everything so as not to pinch brake lines, vent tubes, etc. Clear lines if necessary.
2. Inflate the air springs to 75-90 PSI and check all connections for leaks.
3. Air Lift part #27669 or #27671, AutoPilot V2 Air Management System, is highly recommended for this product.
4. Please familiarize yourself further with this product by reading the Product Use, Maintenance and Servicing section.

INSTALLATION CHECKLIST

- Clearance test — Inflate the air springs to 75-90 PSI and make sure there is at least 1/2" clearance from anything that might rub against each sleeve. Be sure to check the tire, brake drum, frame, shock absorbers and brake cables.
- Leak test before road test — Inflate the air springs to 75-90 PSI and check all connections for leaks. All leaks must be eliminated before the vehicle is road tested.
- Heat test — Be sure there is sufficient clearance from heat sources, at least 6" for air springs and air lines. If a heat shield was included in the kit, install it. If there is no heat shield, but one is required, call Air Lift customer service at (800) 248-0892.
- Fastener test — Recheck all bolts for proper torque.
- Road test — The vehicle should be road tested after the preceding tests. Inflate the springs to recommended driving pressures. Drive the vehicle 10 miles and recheck for clearance, loose fasteners and air leaks.
- Operating instructions — If professionally installed, the installer should review the operating instructions with the owner. Be sure to provide the owner with all of the paperwork that came with the kit.

Technician's Signature _____

Date _____

POST-INSTALLATION CHECKLIST

- Overnight leak down test — Recheck air pressure after the vehicle has been used for 24 hours. If the pressure has dropped more than 5 PSI, then there is a leak that must be fixed. Either fix the leak yourself or return to the installer for service.
- Air pressure requirements — Regardless of load, the air pressure should always be adjusted to maintain adequate ride height at all times while driving.
- Thirty day or 500 mile test — Recheck the air spring system after 30 days or 500 miles, whichever comes first. If any part shows signs of rubbing or abrasion, the source should be identified and moved, if possible. If it is not possible to relocate the cause of the abrasion, the air spring may need to be remounted. If professionally installed, the installer should be consulted. Check all fasteners for tightness.

Product Use, Maintenance and Servicing

| Suggested Driving Air Pressure | Maximum Air Pressure |
|--|----------------------|
| 40 PSI | 125 PSI |
| FAILURE TO MAINTAIN ADEQUATE MINIMUM PRESSURE (OR PRESSURE PROPORTIONAL TO LOAD) WILL RESULT IN BOTTOMING OUT, OVER-EXTENSION OR RUBBING AGAINST ANOTHER COMPONENT AND WILL VOID THE WARRANTY . | |

MAINTENANCE GUIDELINES

NOTE

By following these steps, vehicle owners will obtain the longest life and best results from their air spring.

1. Check the air pressure before driving.
2. Never inflate beyond 125 PSI.
3. If you develop an air leak in the system, use a soapy water solution to check all air line connections, before deflating and removing the spring.
4. When increasing load, always adjust the air pressure to maintain normal ride height. Increase or decrease pressure from the system as necessary to attain normal ride height for optimal ride and handling. Remember that loads carried behind the axle (including tongue loads) require more leveling force (pressure) than those carried directly over the axle.

CAUTION

FOR YOUR SAFETY AND TO PREVENT DAMAGE TO YOUR VEHICLE, DO NOT EXCEED MAXIMUM GROSS VEHICLE WEIGHT RATING (GVWR), AS INDICATED BY THE VEHICLE MANUFACTURER. ALTHOUGH YOUR AIR SPRINGS ARE RATED AT A MAXIMUM INFLATION PRESSURE OF 125 PSI, THE AIR PRESSURE ACTUALLY NEEDED IS DEPENDENT ON YOUR LOAD.

5. Always add air to the springs in small quantities, checking the pressure frequently. Sleeves require less air volume than a tire and inflate quickly.
6. Should it become necessary to raise the vehicle by the frame, make sure the control system is turned off before lifting.

Troubleshooting Guide

1. Leak test the air line connections, the threaded connection into the air spring, and all fittings in the control system.
2. Inspect the air lines to be sure none are pinched. Tie straps may be too tight. Loosen or replace the strap and replace leaking components.
3. Inspect the air line for holes and cracks. Replace as needed.
4. Look for a kink or fold in the air line. Reroute as needed.

If the preceding steps do not solve the problem, it is possibly caused by a failed air spring — either a factory defect or an operating problem. Please call Air Lift at (800) 248-0892 for assistance.

Frequently Asked Questions

Q. Will installing air springs increase the weight ratings of a vehicle?

No. Adding air springs will not change the weight ratings (GAWR, GCWR and/or GVWR) of a vehicle. Exceeding the GVWR is dangerous and voids the Air Lift warranty.

Q. How long should air springs last?

If the air springs are properly installed and maintained they can last indefinitely.

Q. Will raising the vehicle on a hoist for service work damage the air springs?

No. The vehicle can be lifted on a hoist for short-term service work such as tire rotation or oil changes. However, if the vehicle will be on the hoist for a prolonged period of time, support the axle with jack stands in order to take the tension off of the air springs.

Tuning the Air Pressure

Pressure determination comes down to three things — level vehicle, ride comfort, and stability.

1. Level vehicle

If the vehicle's headlights are shining into the trees or the vehicle is leaning to one side, then it is not level. Raise the air pressure to correct either of these problems and level the vehicle.

2. Ride comfort

If the vehicle has a rough or harsh ride it may be due to either too much pressure or not enough. Try different pressures to determine the best ride comfort. See Air Lift suggested driving air pressure.

3. Stability

Stability translates into safety and should be the priority, meaning the driver may need to sacrifice a perfectly level and comfortable ride. Stability issues include roll control, bounce, dive during braking and sponginess. Tuning out these problems usually requires additional air pressure, strut damping, or both.

Checking for leaks

1. Inflate the air spring to 80 PSI.
2. Spray all connections and the inflation valves with a solution of 1/5 liquid dish soap and 4/5 water. Spot leaks easily by looking for bubbles in the soapy water.
3. After the test, deflate the springs to the minimum pressure required to restore the system to normal ride height.
4. Check the air pressure again after 24 hours. A 2-4 PSI loss after initial installation is normal. Retest for leaks if the loss is more than 5 PSI.

Fixing Leaks

1. If there is a problem with a swivel fitting:
 - a. Check the air line connection by deflating the spring and removing the line by pulling the collar against the fitting and pulling firmly on the air line. Trim 1" off the end of the air line. Be sure the cut is clean and square (see fig. 33). Reinsert the air line into the push-to-connect fitting.
 - b. Check the threaded connection by tightening the swivel fitting another ½ turn. If it still leaks, deflate the air spring, remove the fitting, and re-coat the threads with thread sealant. Reinstall by hand tightening as much as possible and then use a wrench for an additional two turns.
2. If the preceding steps have not resolved the problem, call Air Lift customer service at (800) 248-0892.

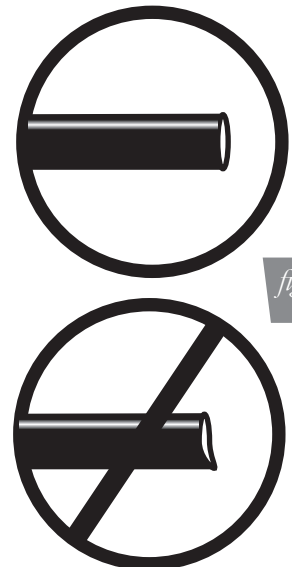

fig. 33

Warranty and Returns Policy

Air Lift Performance warrants its performance products for one year to the original purchaser against manufacturing defects one year from the date of purchase when used on cars and trucks as specified under normal operating conditions. The warranty does not apply to products that have been improperly applied, improperly installed, or which have not been maintained in accordance with installation instructions furnished with all products. The consumer will be responsible for removing (labor charges) the defective product from the vehicle and returning it, transportation costs prepaid, to the dealer from which it was purchased or to Air Lift Performance for verification.

Air Lift will repair or replace, at its option, defective products or components. A minimum \$10.00 shipping and handling charge will apply to all warranty claims. Before returning any defective product, you must call Air Lift at (800) 248-0892 in the U.S. and Canada (elsewhere, (517) 322-2144) for a Returned Materials Authorization (RMA) number. Returns to Air Lift can be sent to: Air Lift Performance • 2727 Snow Road • Lansing, MI • 48917.

Product failures resulting from abnormal use or misuse are excluded from this warranty. The loss of use of the product, loss of time, inconvenience, commercial loss or consequential damages is not covered. The consumer is responsible for installation/reinstallation (labor charges) of the product. Air Lift Performance reserves the right to change the design of any product without assuming any obligation to modify any product previously manufactured.

This warranty gives you specific legal rights and you may also have other rights that may vary from state-to-state. Some states do not allow limitations on how long an implied warranty lasts or allow the exclusion or limitation of incidental or consequential damages. The above limitation or exclusion may not apply to you. There are no warranties, expressed or implied including any implied warranties of merchantability and fitness, which extend beyond this warranty period. There are no warranties that extend beyond the description on the face hereof. Seller disclaims the implied warranty of merchantability. (Dated proof of purchase required.)

Replacement Information

If you need replacement parts, contact the local dealer or call Air Lift customer service at (800) 248-0892. Most parts are immediately available and can be shipped the same day.

Contact Air Lift Performance customer service at (800) 248-0892 first if:

- Parts are missing from the kit.
- Need technical assistance on installation or operation.
- Broken or defective parts in the kit.
- Wrong parts in the kit.
- Have a warranty claim or question.

Contact the retailer where the kit was purchased:

- If it is necessary to return or exchange the kit for any reason.
- If there is a problem with shipping if shipped from the retailer.
- If there is a problem with the price.

Contact Information

If you have any questions, comments or need technical assistance contact our customer service department by calling (800) 248-0892. For calls from outside the USA or Canada, our local number is (517) 322-2144. You may also contact customer service anytime by e-mail at techsupport@airliftperformance.com.

For inquiries by mail, our address is PO Box 80167, Lansing, MI 48908-0167. Our shipping address for returns is 2727 Snow Road, Lansing, MI 48917.

You may also contact our sales team anytime by e-mail at sales@airliftperformance.com or on the web at www.airliftperformance.com.

Notes

Notes

Notes

Need Help?

Contact our customer service department by calling (800) 248-0892. For calls from outside the USA or Canada, our local number is (517) 322-2144.



Thank you for purchasing Air Lift Performance products!

Air Lift Performance • 2727 Snow Road • Lansing, MI 48917 or PO Box 80167 • Lansing, MI 48908-0167
Toll Free (800) 248-0892 • Local (517) 322-2144 • Fax (517) 322-0240 • www.airliftperformance.com

Printed in
the USA

Air Lift[™] **PERFORMANCE**

Kit 27666 Manual Air Management System



INSTALLATION GUIDE

For maximum effectiveness and safety, please read these instructions completely before proceeding with installation.

Failure to read these instructions can result in an incorrect installation.

TABLE OF CONTENTS

| | |
|--|------------|
| Introduction | 2 |
| Important Safety Notice | 2 |
| Notation Explanation | 2 |
| Hardware List | 3 |
| NPT Assembly Instructions | 3 |
| Helpful Tips: Air Line and Fittings | 3 |
| Installing the Air Management System | 4 |
| Install Components | 4 |
| Mounting the Switch Panel | 5 |
| Attaching the Air Lines | 5 |
| Troubleshooting Guide | 6 |
| Tuning the Air Pressure | 7 |
| Leak Testing and Detection | 7 |
| Installation Diagram | 8-9 |
| Warranty and Returns Policy | 10 |
| Replacement Information | 11 |
| Contact Information | 11 |
| Electrical Schematic | 12 |
| Paddle Switch Mounting Bracket Template | 13 |
| 16380 Compressor Template | 15 |

Introduction

The purpose of this publication is to assist with the installation, maintenance and troubleshooting of the Air Management System.

It is important to read and understand the entire installation guide before beginning installation or performing any maintenance, service or repair. The information here includes a hardware list, tool list, step-by-step installation information, maintenance guidelines and troubleshooting guide.

Air Lift Company reserves the right to make changes and improvements to its products and publications at any time. For the latest version of this manual, contact Air Lift Company at (800) 248-0892 or visit our website at www.airliftcompany.com.

IMPORTANT SAFETY NOTICE

The installation of this kit does not alter the Gross Vehicle Weight Rating (GVWR) or payload of the vehicle. Check your vehicle's owner's manual and do not exceed the maximum load listed for your vehicle.

Gross Vehicle Weight Rating: The maximum allowable weight of the fully loaded vehicle (including passengers and cargo). This number — along with other weight limits, as well as tire, rim size and inflation pressure data — is shown on the vehicle's Safety Compliance Certification Label.

Payload: The combined, maximum allowable weight of cargo and passengers that the vehicle is designed to carry. Payload is GVWR minus the Base Curb Weight.

NOTATION EXPLANATION

Hazard notations appear in various locations in this publication. Information which is highlighted by one of these notations must be observed to help minimize risk of personal injury or possible improper installation which may render the vehicle unsafe. Notes are used to help emphasize areas of procedural importance and provide helpful suggestions. The following definitions explain the use of these notations as they appear throughout this guide.

 **DANGER**

INDICATES IMMEDIATE HAZARDS WHICH WILL RESULT IN SEVERE PERSONAL INJURY OR DEATH.

 **WARNING**

INDICATES HAZARDS OR UNSAFE PRACTICES WHICH COULD RESULT IN SEVERE PERSONAL INJURY OR DEATH.

 **CAUTION**

INDICATES HAZARDS OR UNSAFE PRACTICES WHICH COULD RESULT IN DAMAGE TO THE MACHINE OR MINOR PERSONAL INJURY.

NOTE

Indicates a procedure, practice or hint which is important to highlight.

Hardware List

| Item | Part # | Description | Quantity | Item | Part # | Description | Quantity |
|--|--------|---------------------------------|----------|---|--------|--------------------------------|----------|
| A | 16380 | Viair 380C Compressor | 1 | Electrical | | | |
| B | 11955 | 4 Gallon Aluminum Air Tank | 1 | S | 24782 | 30/50A Relay | 1 |
| C | 26228 | Dual Needle Gauge | 2 | T | 24608 | 10 Gauge Red Wire | 15' |
| D | 21703 | Paddle Switch | 4 | U | 24643 | 16 Gauge Red Wire | 20' |
| E | 11031 | Paddle Switch Mounting Bracket | 1 | V | 24644 | 16 Gauge Black Wire | 10' |
| F | 20946 | 1/4" Airline | 80' | W | 24537 | Quick Splice | 3 |
| G | 10530 | Air Line Cutter | 1 | X | 24568 | 18 Gauge Ring Terminal | 2 |
| H | 24575 | 145 - 175 PSI Pressure Switch | 1 | Y | 24594 | Blue Female Spade Terminal | 9 |
| Paddle Switch Mounting Bracket Hardware | | | | Z | 24748 | 12 Gauge Ring Terminal 3/8" ID | 1 |
| I | 17434 | #8 x 3/4" Stainless Steel Screw | 4 | AA | 24542 | Fuse Tap | 1 |
| Tank Mounting Hardware | | | | BB | 24561 | Mini Fuse Adapter | 1 |
| J | 17188 | 3/8"-16 x 1.25" Grade 5 Bolt | 4 | CC | 24649 | Yellow Butt Connector | 1 |
| K | 18444 | 3/8" Flat Washer | 8 | DD | 24595 | Yellow Female Spade Terminal | 2 |
| L | 18435 | 3/8"-16 Nyloc Nut | 4 | EE | 17263 | 1/4" x 1" Self Threading Screw | 1 |
| Tank Fittings | | | | FF | 24539 | Fuse Holder | 1 |
| M | 21737 | 3/8" Pipe Plug | 1 | GG | 24547 | 30A Spade Fuse | 1 |
| N | 21738 | 1/4" FNPT x 3/8" MNPT Bushing | 1 | HH | 17132 | 1/2" Self Threading Screw | 2 |
| O | 21779 | 1/4" NPT x 1/4" Tube Elbow | 2 | Gauge and Paddle Switch Fittings | | | |
| P | 21610 | 1/8" FNPT x 1/4" MNPT Bushing | 1 | II | 21838 | 1/4" Union Tee | 4 |
| Q | 21633 | Inflation Valve | 1 | JJ | 21842 | 1/4" Y Tee | 3 |
| R | 23586 | Thread Sealant | 1 | | | | |



Missing or damaged parts? Call Air Lift customer service at (800) 248-0892 for a replacement part.

NPT ASSEMBLY INSTRUCTIONS

1. Inspect the port and fitting ensuring both are free of contaminants and excessive burrs and nicks.
2. Apply a stripe of liquid pipe sealant around the male threads leaving the first two threads uncovered.
3. Screw finger tight into the port.
4. Wrench tighten the fitting to the correct turns past finger tight position (see table 1).



NEVER BACK OFF AN INSTALLED PIPE FITTING TO ACHIEVE PROPER ALIGNMENT. LOOSENING INSTALLED PIPE FITTINGS WILL CORRUPT THE SEAL AND CONTRIBUTE TO LEAKAGE AND FAILURE.

| Torque Specifications | | |
|-----------------------|-------------------------|--------------|
| Fitting Size | Turns Past Finger Tight | Torque lb/ft |
| 1/8" NPT | 1.5 - 3.0 | 12 |
| 1/4" NPT | 1.5 - 3.0 | 25 |
| 3/8" NPT | 1.5 - 3.0 | 40 |
| 1/2" NPT | 1.5 - 3.0 | 54 |
| 3/4" NPT | 1.5 - 3.0 | 78 |
| 1" NPT | 1 - 2.5 | 112 |
| 1 1/4" NPT | 1 - 2.5 | 154 |
| 1 1/2" NPT | 1 - 2.5 | 211 |
| 2" NPT | 1 - 2.5 | 300 |

Table 1

HELPFUL TIPS: AIR LINE AND FITTINGS

1. Minimum hose bend radius
 - 1/4" hose = 1" hose bend radius.
2. Hose to fitting
 - No side loading on fitting from hose.
 - Hose straight for 1" before bending.
3. Hose cutting
 - Cut hose perpendicular to hose length.
 - Inspect hose for scratches that run lengthwise on hose prior to insertion.
 - Use proper hose cutter, cigar cutter, or razor on flat surface.
4. DOT/SAEJ844 air brake hose data
 - Maximum working pressure of 175 PSI.
 - Not to be used for frame (body) to un-sprung mass connection, use a braided leader hose for this moving connection.

| Compressor Tank Pressure | | |
|--------------------------|--------------|--------------------|
| Viair | Air Lift P/N | Max. Tank Pressure |
| 380C | 16380 | 175 |
| 400C | 16400 | 150 |
| 444C | 16444 | 175 |
| 450C | 16450 | 150 |

Table 2

Installing the Air Management System

INSTALL COMPONENTS

NOTE

For a complete schematic, please see fig. 1. (pages 8 – 9)

Layout

1. Plan component location first.
2. Prior to mounting components, check to make sure:
 - the compressor leader hose will reach the tank.
 - the plumbing will route cleanly through the vehicle.

NOTE

Be sure to install all components as far as possible from any heat sources. Plan and prepare wiring and plumbing routing thru the vehicle. Eliminate all sharp edges that could chafe. Use grommets when passing through compartment walls.

Prepare and install the compressor

1. Prepare the compressor intake. If inside the vehicle, attach filter to port on end of compressor (fig. 1). If the compressor is located outside the vehicle, snorkel inlet filter to a dry location inside vehicle using components supplied with the compressor.
2. Center punch and drill four holes using the template on page 15.
3. Attach using the hardware supplied with the compressor.

NOTE

Air compressors ingest moisture and will deposit water in the tank. Tanks must be regularly purged to eliminate the possibility of water freezing inside the system or causing corrosion. Be sure to provide easy access to drain/fill valve (preferably outside the vehicle). The system does not include moisture separators or water traps, and does require periodic tank moisture drain. If using an engine driven compressor, proper oil and water filtration must be added as these compressors will contaminate the air suspension system. Water traps are available and sold separately through Air Lift Performance, part numbers: 21011 (1/4"), 21012 (3/8"), 21013 (1/2").

Tank pre-assembly (see fig. 1)

1. Determine tank location and orientation prior to installing fittings.
2. Apply thread sealant as necessary to all fittings.
3. Install the drain/fill PTC fitting in the lower most tank threaded port.
4. Choose a tank threaded port for the compressor fitting.
5. Choose the highest tank threaded port for air line supply.
6. Plug any remaining tank ports with hex plugs.

Tank install (see fig. 1)

1. Using the tank feet as a template, drill holes for hardware assembly.
2. Attach the tank using the supplied hardware.
3. Cut an appropriate length of hose from the manifold port T, to the PTC fitting on the tank.
4. Route the drain/fill air line with a schrader valve (preferably outside the vehicle).

NOTE

When cutting plastic air line, only use a standard hose cutter like (Air Lift part number 10530) or razorblade. Cut all hose ends square and as smoothly as possible. See hose cutting tips on page 4.

MOUNTING THE SWITCH PANEL

Refer to the switch panel template on page 13.

1. Find a location to mount the paddle switch mounting bracket (E).
2. Snap all four paddle switches (D) into the paddle switch mounting bracket (E) so the DEL is toward the top.

NOTE

You may select different locations for the paddle switches. The paddle switches do not need to be used with the supplied paddle switch mounting bracket.

3. Cut six pieces of air line (F) the same length (approximately 3"-6").
4. Push four of these pieces onto the "SUP" port of the switch. Attach two Y fittings (JJ) to the air lines.
5. Push the other two pieces of line into the Y fittings (JJ).
6. Attach the last Y fitting (JJ) to the air lines.
7. Mount the paddle switch mounting bracket (E) with four screws (I).

ATTACHING THE AIR LINES **CAUTION**

WHEN CUTTING OR TRIMMING THE AIR LINE, USE AN AIR LINE CUTTER (G), A RAZOR BLADE OR A SHARP KNIFE. A CLEAN, SQUARE CUT WILL ENSURE AGAINST LEAKS. DO NOT USE WIRE CUTTERS OR SCISSORS TO CUT THE AIR LINE. THESE TOOLS MAY FLATTEN OR CRIMP THE AIR LINE, CAUSING IT TO LEAK.

1. Run a length of air line (F) from the air fitting on the compressor to the end of the switch cluster.
2. Run a length of air line from the remaining air fittings on the switch to its respective air spring.
3. Repeat step 2 for the remaining air fittings and air springs.
4. Use a tee and connect into each one of the air spring lines to connect to its respective gauge port.
5. Test and make sure that the switches operate the appropriate air springs.

Troubleshooting Guide

For further technical assistance please contact our customer service department by calling (800) 248-0892, Monday through Friday. For calls from outside the USA or Canada, our local number is (517) 322-2144.

| PROBLEM | CAUSE | SOLUTION |
|---|---|---|
| <i>Compressor doesn't run</i> | There is a blown fuse or relay, bad ground, or poor electrical connections. | Replace the fuse, check the ground wire, or check the compressor connector |
| <i>Compressor runs all the time.</i> | The compressor relay is defective or there is a leak. | Replace the relay or locate the leak and repair. |
| <i>Air spring or tank leak.</i> | Fitting seal or air line is compromised. | Check to make sure air lines are seated in connectors. Inspect fittings with soapy water. Trim hose or re-seal fitting. |
| <i>Compressors runs all the time but doesn't fill the tank.</i> | Compressor in-line check valve fitting has been overtorqued. | Loosen fitting and check again. Replace if needed. |

Tuning the Air Pressure

Pressure determination comes down to three things — level vehicle, ride comfort, and stability.

1. Level vehicle

If the vehicle's headlights are shining into the trees or the vehicle is leaning to one side, then it is not level. Raise the air pressure to correct either of these problems and level the vehicle.

2. Ride comfort

If the vehicle has a rough or harsh ride it may be due to either too much pressure or not enough. Try different pressures to determine the best ride comfort.

3. Stability

Stability translates into safety and should be the priority, meaning the driver may need to sacrifice a perfectly level and comfortable ride. Stability issues include roll control, bounce, dive during braking and sponginess. Tuning out these problems usually requires an increase in pressure.

Leak Testing and Detection

Leak detection

1. A leak can be defined as a loss of pressure of more than 5 psi over an 8 hour period. Be aware that ambient temperature change has an effect on pressure that may seem like a leak. For example: a change of 10° Fahrenheit up or down from your baseline will have an approximate gain or loss of indicated pressure of 2 psi. If a leak is suspected after including any temperature change, then proceed to #2.
2. Spray soapy water (1/5 Dawn brand dish soap to 4/5 water) on suspect fittings and hose connections and look for any bubbling caused by air leakage.
3. Fix leaking connection (review pages 3 and 4 for help on NPT fittings and air line connections).
4. Wipe down sprayed connections with rag to remove any residual soapy water.

NOTE

Dawn brand dish soap will not corrode the metals (aluminum, brass, steel) with which it comes into contact.

Installation Diagram

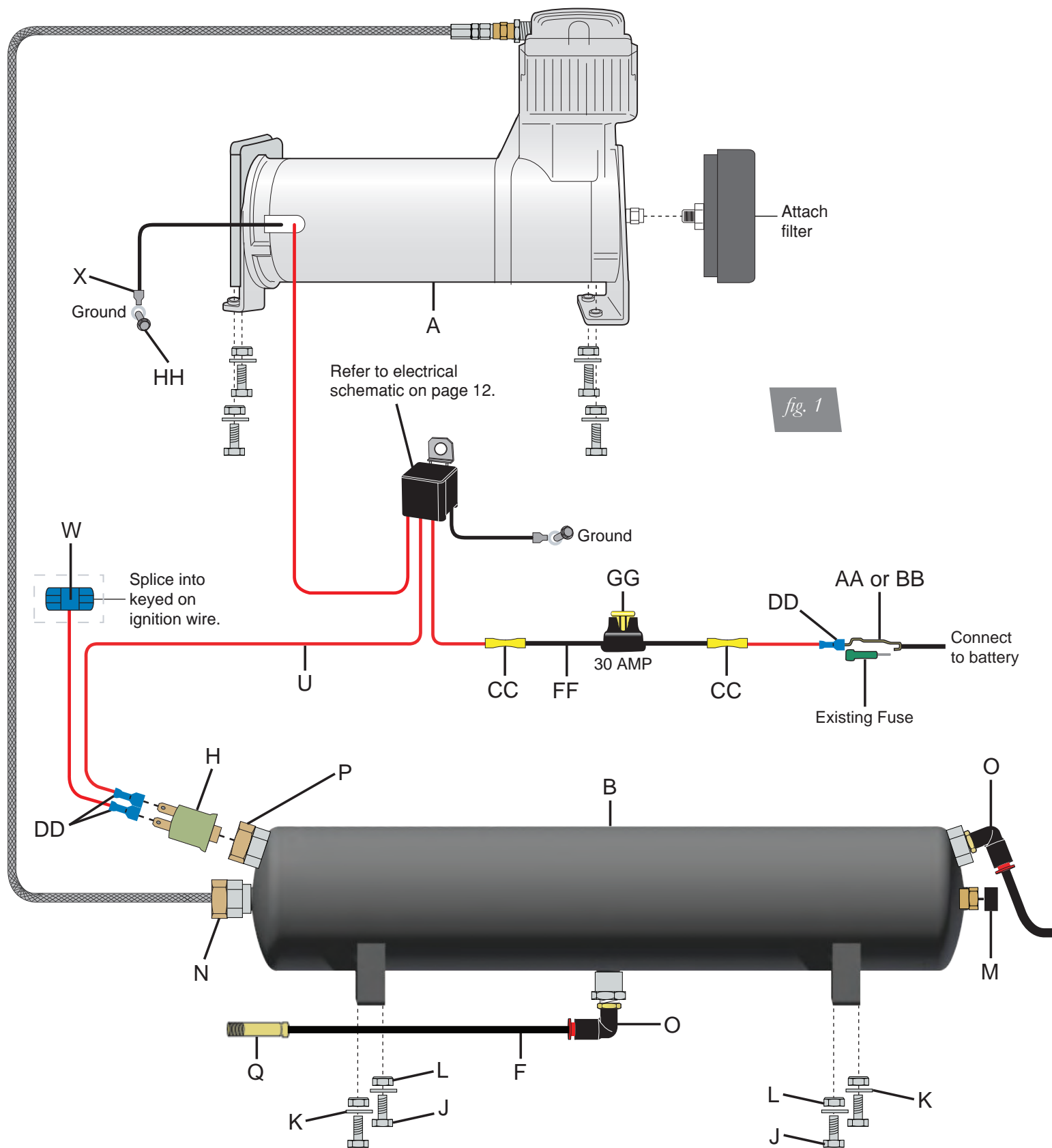

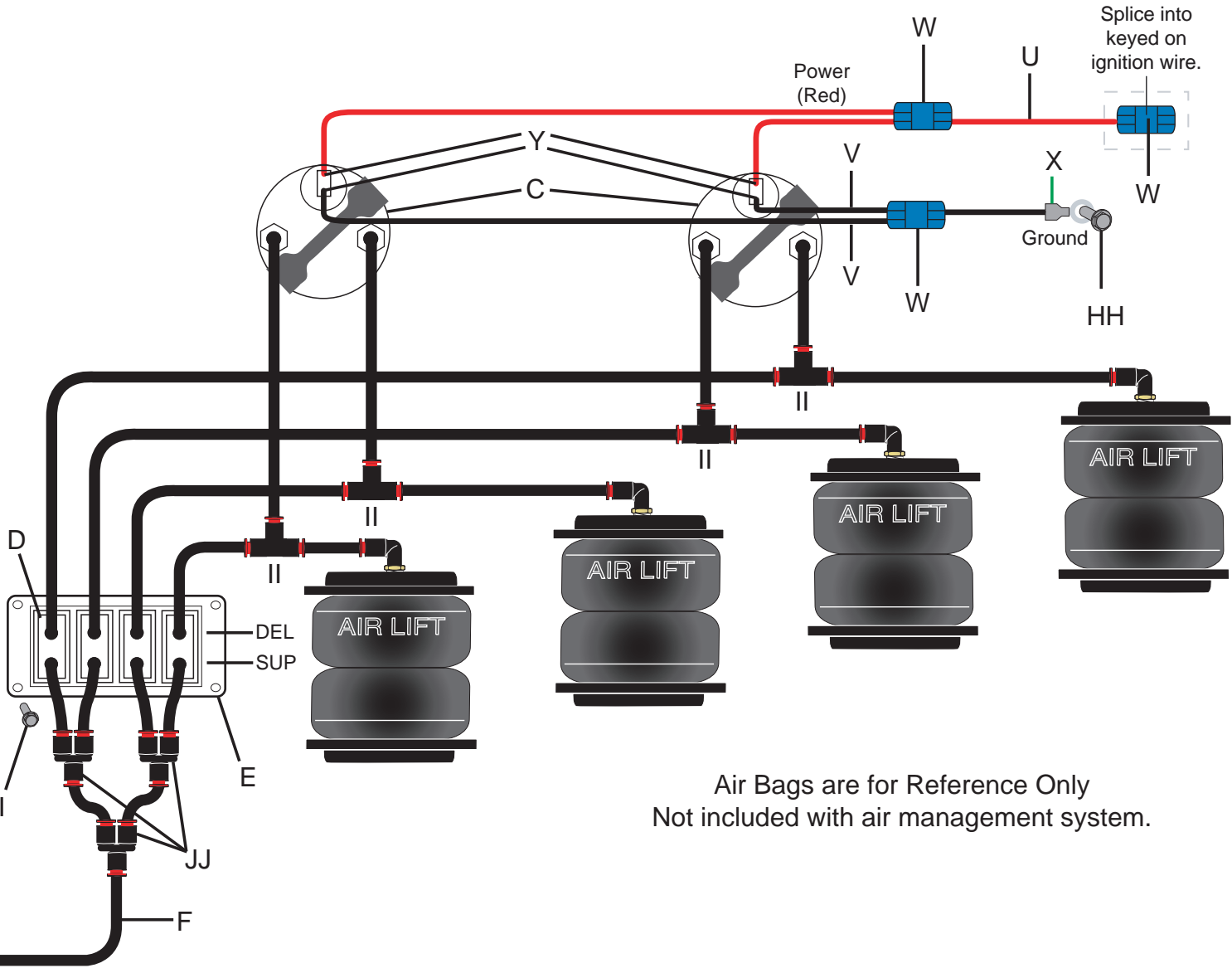
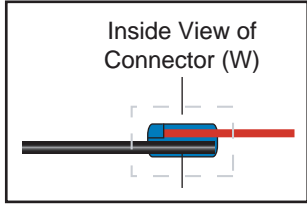

Air Bags are for Reference Only
Not included with air management system.

NOTE: Air Lift recommends using a hose cutting tool to ensure a proper cut. If a hose connection has been disconnected the hose must be trimmed 1/2" back to provide for a leak free seal.

Warranty and Returns Policy

Air Lift Company warrants its products, for the time periods listed below, to the original retail purchaser against manufacturing defects when used on catalog-listed applications on cars, vans, light trucks and motorhomes under normal operating conditions for as long as Air Lift manufactures the product. The warranty does not apply to products that have been improperly applied, improperly installed, used in racing or off-road applications, used for commercial purposes, or which have not been maintained in accordance with installation instructions furnished with all products. The consumer will be responsible for removing (labor charges) the defective product from the vehicle and returning it, transportation costs prepaid, to the dealer from which it was purchased or to Air Lift Company for verification.

Air Lift will repair or replace, at its option, defective products or components. A minimum \$10.00 shipping and handling charge will apply to all warranty claims. Before returning any defective product, you must call Air Lift at (800) 248-0892 in the U.S. and Canada (elsewhere, (517) 322-2144) for a Returned Materials Authorization (RMA) number. Returns to Air Lift can be sent to: Air Lift Company • 2727 Snow Road • Lansing, MI • 48917.

Product failures resulting from abnormal use or misuse are excluded from this warranty. The loss of use of the product, loss of time, inconvenience, commercial loss or consequential damages is not covered. The consumer is responsible for installation/reinstallation (labor charges) of the product. Air Lift Company reserves the right to change the design of any product without assuming any obligation to modify any product previously manufactured.

This warranty gives you specific legal rights and you may also have other rights that vary from state-to-state. Some states do not allow limitations on how long an implied warranty lasts or allow the exclusion or limitation of incidental or consequential damages. The above limitation or exclusion may not apply to you. There are no warranties, expressed or implied including any implied warranties of merchantability and fitness, which extend beyond this warranty period. There are no warranties that extend beyond the description on the face hereof. Seller disclaims the implied warranty of merchantability. (Dated proof of purchase required.)

| | | | |
|--------------------------------------|-------------------------|------------------------------------|-----------------------|
| Air Lift 1000™ | Lifetime Limited | LoadController/Dual™ | 2 Year Limited |
| RideControl™ | Lifetime Limited | Load Controller™ (I) | 2 Year Limited |
| LoadLifter 5000™* | Lifetime Limited | Load Controller™ (II) | 2 Year Limited |
| SlamAir™ | Lifetime Limited | SmartAir™ | 2 Year Limited |
| AirCell™ | Lifetime Limited | Wireless AIR™ | 2 Year Limited |
| Air Lift Performance™** | 1 Year Limited | WirelessONE™ | 2 Year Limited |
| LoadController/Single™ .. | 2 Year Limited | Other Accessories | 2 Year Limited |

**formerly SuperDuty*

***formerly LifeStyle & Performance and Easystreet*

Replacement Information

If you need replacement parts, contact the local dealer or call Air Lift customer service at (800) 248-0892. Most parts are immediately available and can be shipped the same day.

Contact Air Lift Company customer service at (800) 248-0892 first if:

- Parts are missing from the kit.
- Need technical assistance on installation or operation.
- Broken or defective parts in the kit.
- Wrong parts in the kit.
- Have a warranty claim or question.

Contact the retailer where the kit was purchased:

- If it is necessary to return or exchange the kit for any reason.
- If there is a problem with shipping if shipped from the retailer.
- If there is a problem with the price.

Contact Information

If you have any questions, comments or need technical assistance contact our customer service department by calling (800) 248-0892, Monday through Friday. For calls from outside the USA or Canada, our local number is (517) 322-2144.

For inquiries by mail, our address is PO Box 80167, Lansing, MI 48908-0167. Our shipping address for returns is 2727 Snow Road, Lansing, MI 48917.

You may also contact us anytime by e-mail at sales@airliftcompany.com or on the web at www.airliftcompany.com.

Electrical Schematic

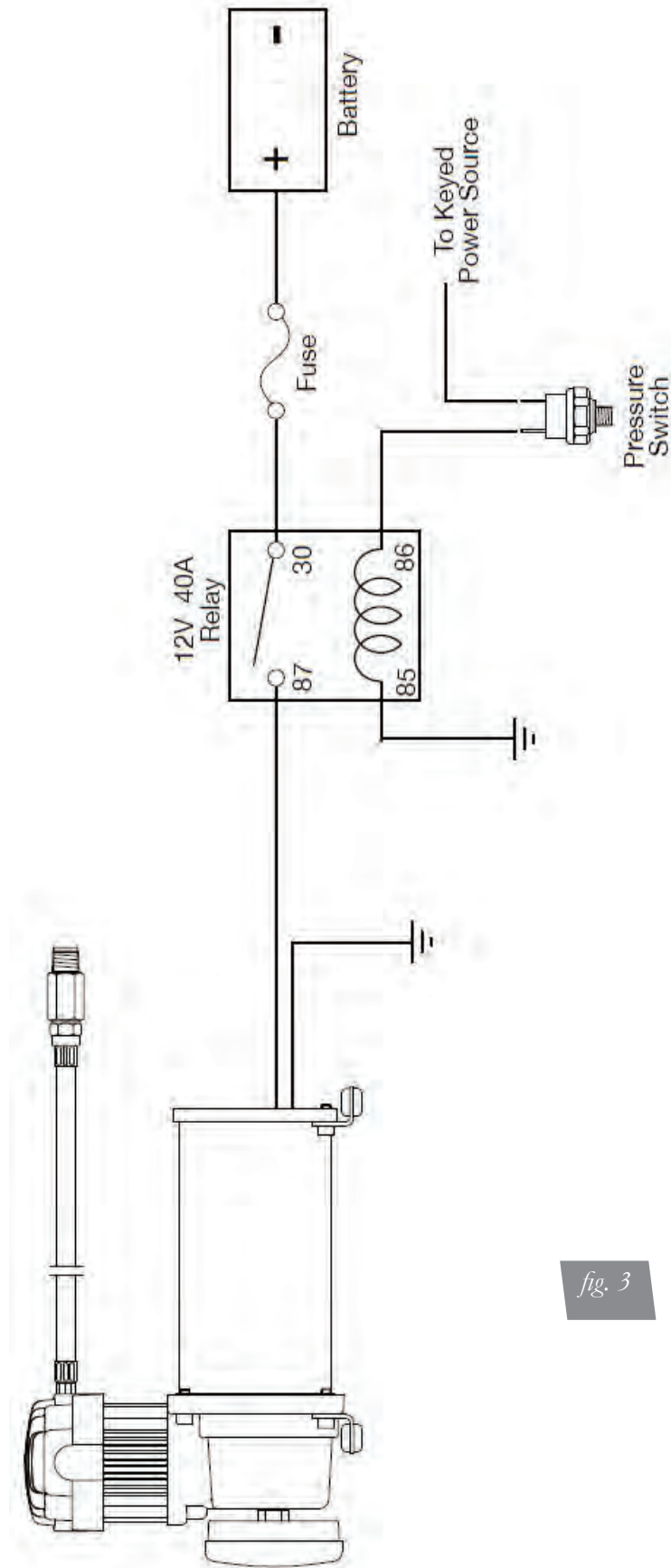
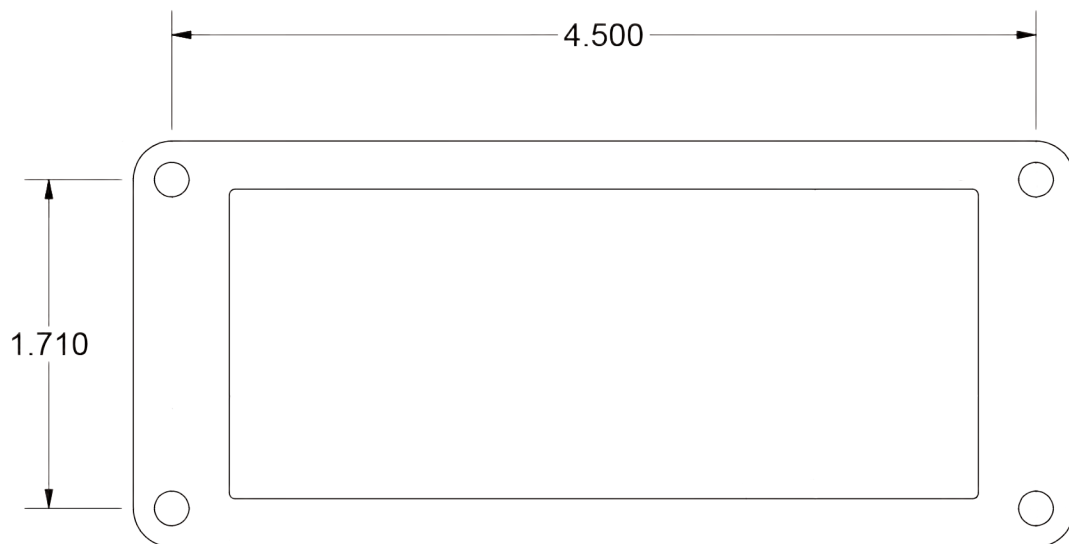
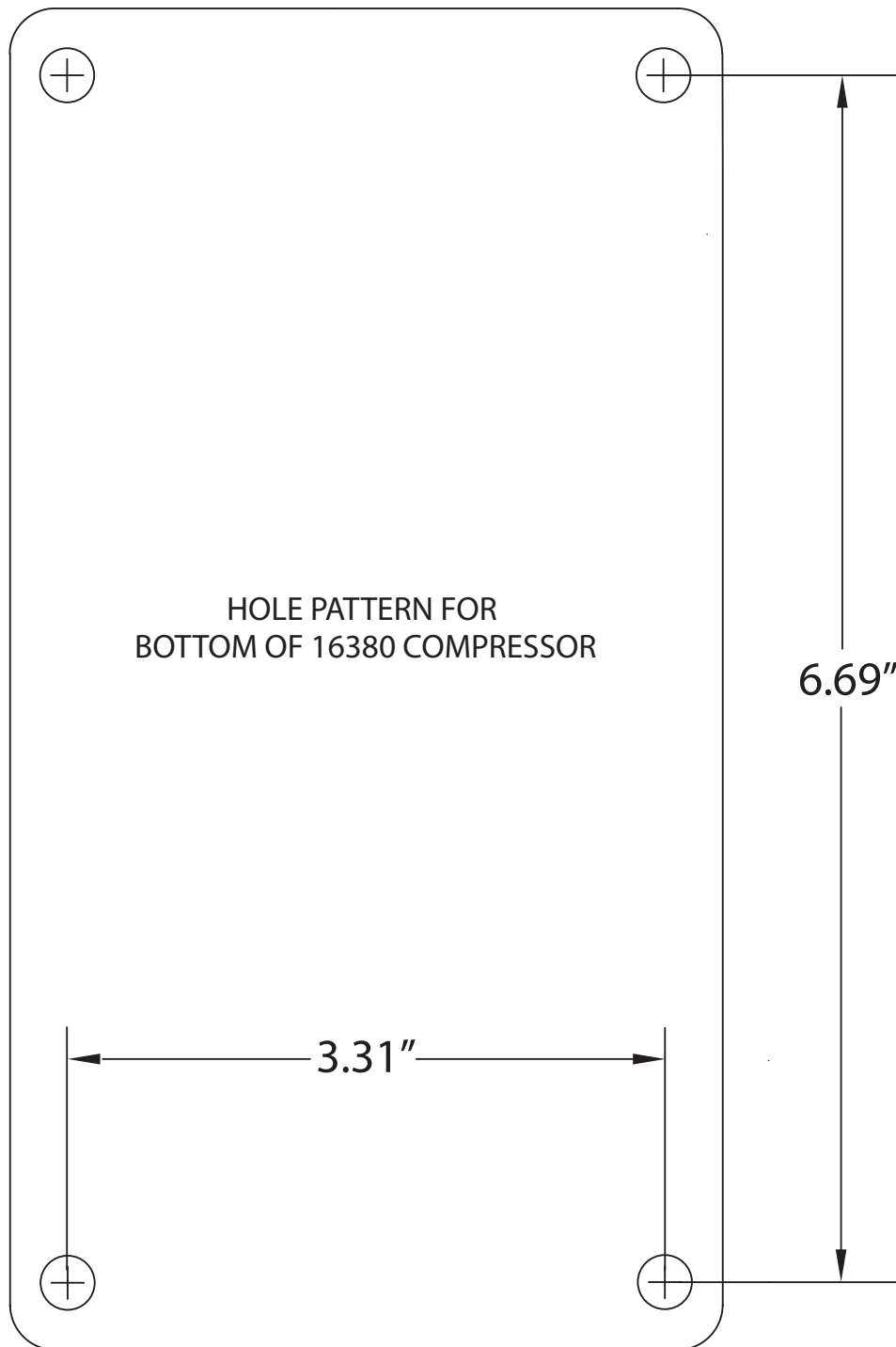

fig. 3

Paddle Switch Mounting Bracket Template



16380 Compressor Template



Need Help?

Contact our customer service department by calling (800) 248-0892, Monday through Friday. For calls from outside the USA or Canada, our local number is (517) 322-2144.



Thank you for purchasing Air Lift Performance products!

Air Lift Performance • 2727 Snow Road • Lansing, MI 48917 or PO Box 80167 • Lansing, MI 48908-0167
Toll Free (800) 248-0892 • Local (517) 322-2144 • Fax (517) 322-0240 • www.airliftperformance.com

Printed in
the USA