

AIRLIFT 1000

P/N 80523

BY
AIRLIFT

MN-75
(12612)
ECN1965

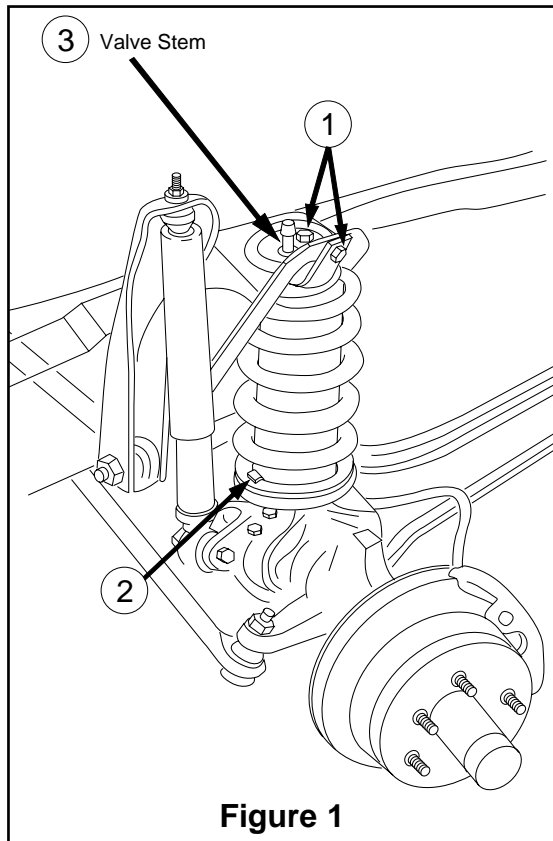

Figure 1

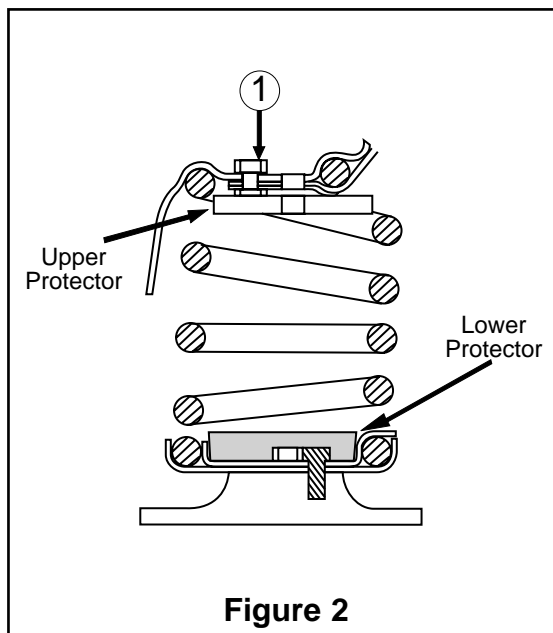
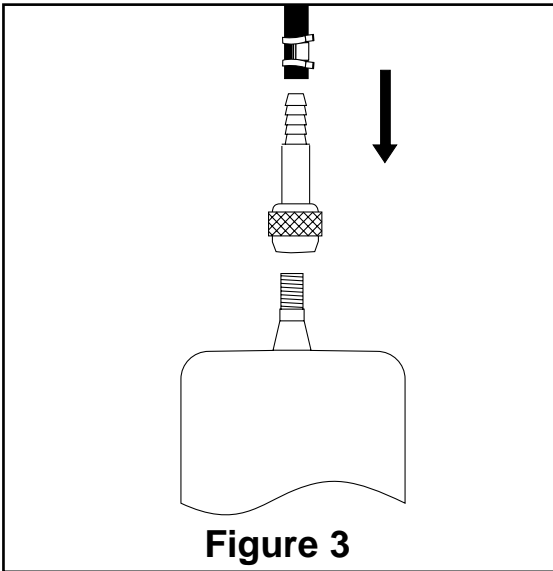

Figure 2

1. Jack up front end of vehicle and place safety stands under axle. Remove front wheels and lower shock absorber attaching bolts.
2. Remove the upper spring retaining bolts (Figure 1, Item 1) and strap. Lower axle or raise body until the spring is loose in the upper seat. CAUTION: Do not strain flexible hydraulic brake line. Remove brake line bracket attaching bolt on axle if necessary.
3. Rotate coil spring in lower spring seat beyond locking tabs to allow spring removal (Figure 1, Item 2). On some models, it may be necessary to loosen lower spring seat retaining bolts.
4. A template is provided to locate a hole in the upper spring seat for valve stem access. The same template is used for both left and right sides. Fold template along dotted line. Place under right hand upper spring seat with type facing downward, right hand arrow forward.
5. Place 3/8" capscrew in template and through outer retaining strap hole. Insert another 3/8" capscrew in one of the inner holes that align with the inner retaining strap hole in the spring seat.
Hole "A" is used on 1973 and up.
Hole "B" is used on 1966 - 1972.
6. Center punch and drill a 1/2" hole at forward star marked R.H.S. Repeat this procedure for left hand side using other star location.
7. Insert air cylinder, stem up, into bottom of coil spring. Push cylinder completely to the top.
8. Replace coil spring in lower spring seat, insuring that it is under the retaining tab (Figure 1, Item 2).
9. Install the upper protector with the offset, smaller hole over the valve stem and centered on the cylinder (Figure 2).
10. Raise axle or lower body to position coil spring into upper spring seat (Figure 2).
11. Install the upper coil retaining strap. Replace the inner 1" long bolt from the upper coil retaining strap with the 3/4" long bolt provided in the package (Figure 2, Item 1).
12. Tighten lower spring seat retaining bolts to specifications if loosened in step 3.
13. Insert lower protector between turns of the coil spring and push firmly into lower spring seat (Figure 2).
14. Rotate cylinder to align valve stem with drilled hole in upper seat.



15. Slowly lower body or raise axle until cylinder contacts upper and lower spring seats. Care should be taken to guide valve stem in the proper location (Figure 1, Item 3).

16. Replace lower shock absorber attaching bolts and tighten.

17. Determine air line routing. A tee air line installation can be used unless weight of vehicle varies from one side to the other and unequal pressures are needed to correct suspension alignment and level vehicle. Dual air lines are used in this case. **CAUTION:** Avoid areas which may cause failure of the air line. For example: battery, exhaust, engine, radiator, and moving parts such as steering, suspension and cables.

18. Proceed with desired air line routing (Tee or Dual).

AIR LINE INSTRUCTIONS

CAUTION: LEAVE SUFFICIENT AIR LINE SLACK TO PREVENT ANY STRAIN ON FITTINGS DURING AXLE MOTIONS.

TO PREVENT AIR LINE FROM MELTING, KEEP IT AT LEAST TWELVE INCHES FROM EXHAUST SYSTEM, ENGINE AND HEAT SOURCES. CAUTION: AVOID AREAS WHICH MAY CAUSE FAILURE OF THE AIR LINE. FOR EXAMPLE: BATTERY, EXHAUST, ENGINE, RADIATOR, AND MOVING PARTS SUCH AS STEERING, SUSPENSION AND CABLES.

TEE AIR LINE CONNECTION:

A. Find desired tee location on the frame rail or radiator core support bracket (Figure 5).

B. Determine and cut adequate length of air line to reach from tee to left and right side on air cylinders.

C. Connect the air line to the two opposite legs on the tee (Figure 4).

D. Route air line to left and right air springs, generally along inner fender panel or frame rails (Figure 5).

E. Slide air line clamp onto the air line. Push the air line over the barbed end of straight fitting. Compress the ears on the air line clamp with pliers and slide it down to cover the barbed section (Figure 4). Repeat for other side.

F. Connect the straight fitting to the right & left air springs and tighten securely (Figure 3).

G. Select a location for inflation valve in the hood release, front bumper, fender flange or behind the license plate, assuring that the valve will be protected and accessible with an air hose.

H. Connect the remaining air line over the last fitting on tee and route along frame to desired inflation valve location. Attach air line to chassis with plastic straps or wire.

I. Drill a 5/16" hole for inflation valve and mount as illustrated (Rubber washer is for outside weather seal (Figure 7)).

J. Connect the air line to the inflation valve (Figure 6).

K. Continue with step 19, page 3.

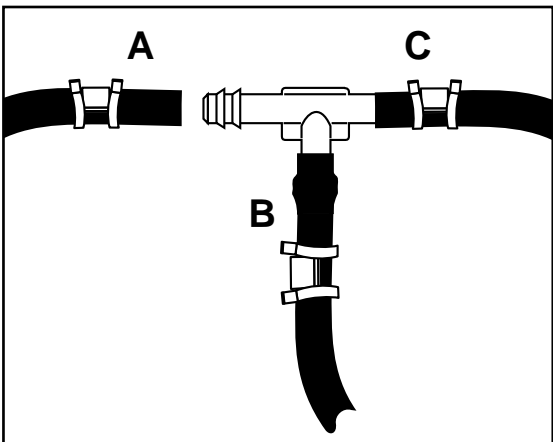

Use this procedure for all air line connections:
A. Slide air line clamp onto the air line
B. Push the air line over the barbed stem.
C. Compress the ears on the air line clamp with pliers and slide it forward to fully cover the barbed section.

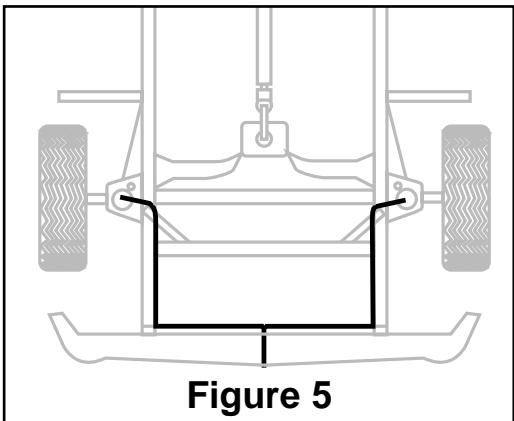

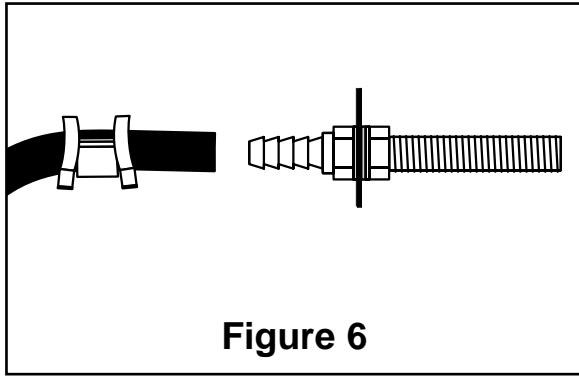

Figure 6

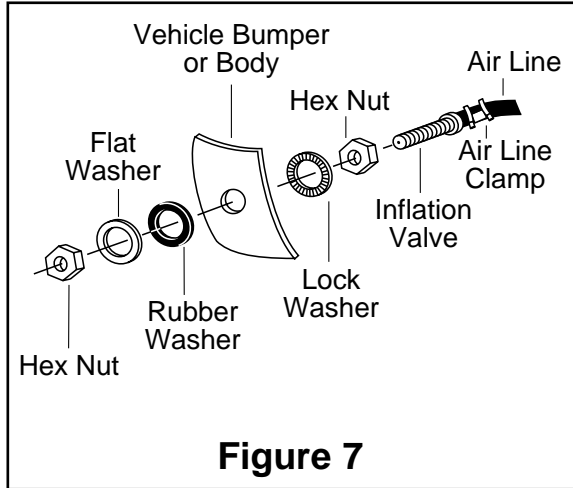

Figure 7

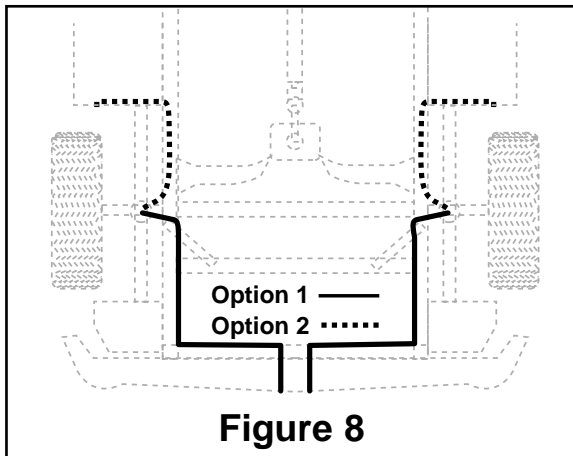

Figure 8

DUAL AIR LINE CONNECTION:

- A. Select a location for the inflation valves in the rocker panel flange or by hood release assuring that each valve will be protected and accessible with an air line.
 - B. Determine and cut adequate length, not longer than 90" of air line to reach from valve location to left side air cylinder.
 - C. Slide air line clamp onto the air line. Push the air line over the barbed end of straight fitting. Compress the ears on the air line clamp with pliers and slide it down to cover the barbed section (Figure 4). Repeat for other side.
 - D. Connect the straight fitting to the right & left air springs and tighten securely (Figure 3).
 - E. Route air line along frame or under fender panel to desired inflation valve location (Figure 8). Attach air line to chassis with plastic straps or wire.
 - F. Drill 5/16" hole for inflating valves and mount as illustrated (Rubber washer is for outside weather seal, Figure 7).
 - G. Connect the air line to the inflation valve.
 - H. Repeat process for other side.
 - I. Continue below with step 19.
19. Replace front wheels and return vehicle to normal standing height.
 20. Inflate cylinders to 50 psi air pressure. Test for air leaks by applying a liquid soap and water solution to all valve cores, fittings and connections. Adjust pressure down until vehicle is visually level and for best ride comfort.
 21. Recheck air pressure after 24 hours. A 2-4 psi loss after initial installation is normal. If pressure has dropped more than 5 lbs re-test for leaks with a soapy water solution.
- * Read Maintenance/Operation for proper care of your air cylinders on page 4.

FAILURE TO MAINTAIN MINIMUM PRESSURE WILL VOID THE WARRANTY

MINIMUM AIR PRESSURE 10 P.S.I.	MAXIMUM AIR PRESSURE 50 P.S.I.
<p>MAINTENANCE TIPS:</p> <ol style="list-style-type: none">1. Check pressure weekly!2. Always maintain at least 5 p.s.i. air pressure to prevent chafing or coil pinch.3. If you develop an air leak in the system, use a soapy/water solution to check all air line connections and the valve core before removing cylinder. <p>OPERATING TIPS:</p> <ol style="list-style-type: none">1. Inflate your air springs to 35 p.s.i. before adding the payload. This will allow the air cylinder to properly mesh with the coil spring. After vehicle is loaded, adjust your air pressure (down) to level the vehicle and for ride comfort.2. When you are carrying a payload it will be helpful to increase the tire inflation pressure in proportion to any overload condition. We recommend a 2 p.s.i. increase above normal (not to exceed tire manufacturers maximum) for each 100 lbs. additional load on the axle.	
	<p>Thank you for purchasing Air Lift Products</p> <p>AIR LIFT COMPANY P.O. BOX 80167 Lansing, MI 48908-0167</p>
<p>FOR TECHNICAL ASSISTANCE CALL 1-800-248-0892</p>	
<p>Caution: DO NOT EXCEED THE VEHICLE MANUFACTURERS MAXIMUM GROSS VEHICLE WEIGHT RATING.</p>	

USE 3/8 CAP SCREW TO ALIGN
TEMPLATE ON RETAINING

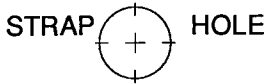

FOLD AWAY APPROX. 30°
ALONG THIS LINE

CENTER PUNCH FORWARD STAR
IN EACH SPRING SEAT
DRILL 1/2" DIA. HOLE

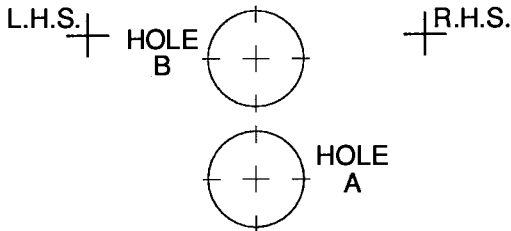

POSITION TEMPLATE ON APPROPRIATE EXISTING
HOLE IN SPRING SEAT

12-461

USE 3/8 CAP SCREW TO ALIGN
TEMPLATE ON RETAINING

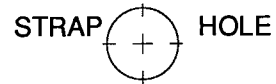

FOLD AWAY APPROX. 30°
ALONG THIS LINE

CENTER PUNCH FORWARD STAR
IN EACH SPRING SEAT
DRILL 1/2" DIA. HOLE

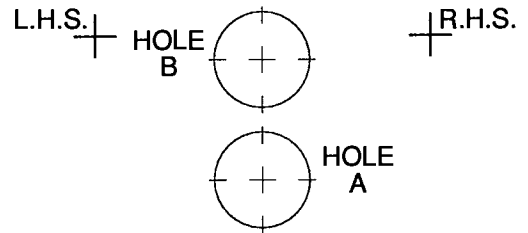

POSITION TEMPLATE ON APPROPRIATE EXISTING
HOLE IN SPRING SEAT

12-461

USE 3/8 CAP SCREW TO ALIGN
TEMPLATE ON RETAINING

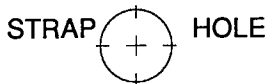

FOLD AWAY APPROX. 30°
ALONG THIS LINE

CENTER PUNCH FORWARD STAR
IN EACH SPRING SEAT
DRILL 1/2" DIA. HOLE

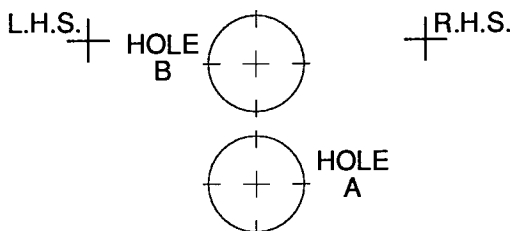

POSITION TEMPLATE ON APPROPRIATE EXISTING
HOLE IN SPRING SEAT

12-461

USE 3/8 CAP SCREW TO ALIGN
TEMPLATE ON RETAINING

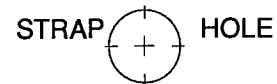

FOLD AWAY APPROX. 30°
ALONG THIS LINE

CENTER PUNCH FORWARD STAR
IN EACH SPRING SEAT
DRILL 1/2" DIA. HOLE

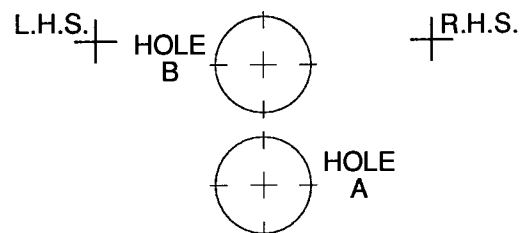

POSITION TEMPLATE ON APPROPRIATE EXISTING
HOLE IN SPRING SEAT

12-461



Product Use Information

Frequently asked questions

Q. Will installing air springs increase the weight ratings of a vehicle?

No. Adding air springs will not change the weight ratings (GAWR, GCWR and/or GVWR) of a vehicle. Exceeding the GVWR is dangerous and voids the Air Lift warranty.

Q. Is it necessary to keep air in the air springs at all time and how much pressure will they need?

The minimum air pressure should be maintained at all times. The minimum air pressure keeps the air spring in shape, ensuring that it will move throughout its travel without rubbing or wearing on itself.

Q. Is it necessary to add a compressor system to the air springs?

No. Air pressure can be adjusted with any type of compressor as long as it can produce sufficient pressure to service the springs. Even a bicycle tire pump can be used, but it's a lot of work.

Q. How long should air springs last?

If the air springs are properly installed and maintained they can last indefinitely.

Q. Will raising the vehicle on a hoist for service work damage the air springs?

No. The vehicle can be lifted on a hoist for short-term service work such as tire rotation or oil changes. However, if the vehicle will be on the hoist for a prolonged period of time, support the axle with jack stands in order to take the tension off of the air springs.

Tuning the air pressure

Pressure determination comes down to three things — level vehicle, ride comfort, and stability.

1. Level vehicle

If the vehicle's headlights are shining into the trees or the vehicle is leaning to one side, then it is not level (fig. 1). Raise the air pressure to correct either of these problems and level the vehicle.

2. Ride comfort

If the vehicle has a rough and harsh ride it may be due to either too much pressure or not enough (fig. 2). Try different pressures to determine the best ride comfort.

3. Stability

Stability translates into safety and should be the priority, meaning the driver may need to sacrifice a perfectly level and comfortable ride. Stability issues include roll control, bounce, dive during braking and sponginess (fig. 3). Tuning out these problems usually requires an increase in pressure.



Bad headlight aim



Sway and body roll



Rough ride

Guidelines for adding air:

1. Start with the vehicle level or slightly above.
2. When in doubt, always add air.
3. For motorhomes, start with 50-100 PSI in the rear because it can be safely assumed that it is heavily loaded.
4. If the front of the vehicle dives while braking, increase the pressure in the front air bags, if equipped.
5. If it is ever suspected that the air bags have bottomed out, increase the pressure (fig. 4).
6. Adjust the pressure up and down to find the best ride.
7. If the vehicle rocks and rolls, adjust the air pressure to reduce movement.
8. It may be necessary to maintain different pressures on each side of the vehicle. Loads such as water, fuel, and appliances will cause the vehicle to be heavier on one side (fig. 5). As much as a 50 PSI difference is not uncommon.

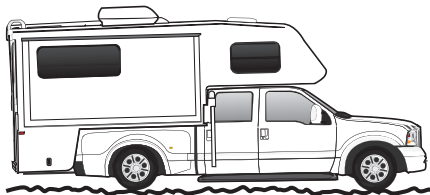

Bottoming out

fig. 4

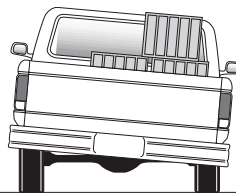

Unlevel

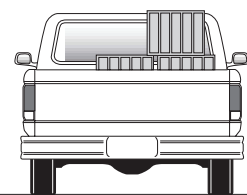

Level

fig. 5

Warranty and Returns Policy

Air Lift Company warrants its products, for the time periods listed below, to the original retail purchaser against manufacturing defects when used on catalog-listed applications on cars, vans, light trucks and motorhomes under normal operating conditions for as long as Air Lift manufactures the product. The warranty does not apply to products that have been improperly applied, improperly installed, used in racing or off-road applications, used for commercial purposes, or which have not been maintained in accordance with installation instructions furnished with all products. The consumer will be responsible for removing (labor charges) the defective product from the vehicle and returning it, transportation costs prepaid, to the dealer from which it was purchased or to Air Lift Company for verification.

Air Lift will repair or replace, at its option, defective products or components. A minimum \$10.00 shipping and handling charge will apply to all warranty claims. Before returning any defective product, you must call Air Lift at (800) 248-0892 in the U.S. and Canada (elsewhere, (517) 322-2144) for a Returned Materials Authorization (RMA) number. Returns to Air Lift can be sent to: Air Lift Company • 2727 Snow Road • Lansing, MI • 48917.

Product failures resulting from abnormal use or misuse are excluded from this warranty. The loss of use of the product, loss of time, inconvenience, commercial loss or consequential damages is not covered. The consumer is responsible for installation/reinstallation (labor charges) of the product. Air Lift Company reserves the right to change the design of any product without assuming any obligation to modify any product previously manufactured.

This warranty gives you specific legal rights and you may also have other rights that vary from state-to-state. Some states do not allow limitations on how long an implied warranty lasts or allow the exclusion or limitation of incidental or consequential damages. The above limitation or exclusion may not apply to you. There are no warranties, expressed or implied including any implied warranties of merchantability and fitness, which extend beyond this warranty period. There are no warranties that extend beyond the description on the face hereof. Seller disclaims the implied warranty of merchantability. (Dated proof of purchase required.)

Air Lift 1000 Lifetime Limited
RideControl Lifetime Limited
SlamAir Lifetime Limited
LoadLifter 5000* Lifetime Limited
EasyStreet Systems 1 Year Limited

Load Controller (I) 2 Year Limited
Load Controller (II) 2 Year Limited
SmartAir 2 Year Limited
Wireless AIR..... 2 Year Limited
Other Accessories..... 2 Year Limited

**formerly SuperDuty*