

Load CONTROLLER™

by AIR LIFT®

Kit 25801



INSTALLATION GUIDE

For maximum effectiveness and safety, please read these instructions completely before proceeding with installation.

Failure to read these instructions can result in an incorrect installation.



TABLE OF CONTENTS



Installation Diagram	2
Installing the LoadController System	3
Mounting the Gauge Panel	3
Mounting the Solenoid.	3
Wiring the Electrical Connections	4
Connecting the Air Lines	4
Product Use, Maintenance and Servicing	6
Troubleshooting Guide	6
Frequently Asked Questions	6
Tuning the Air Pressure	7
Guidelines for Adding Air	7
Warranty and Returns Policy	8
Replacement Information	9
Contact Information	9
Template	10



Installation Diagram

Existing System

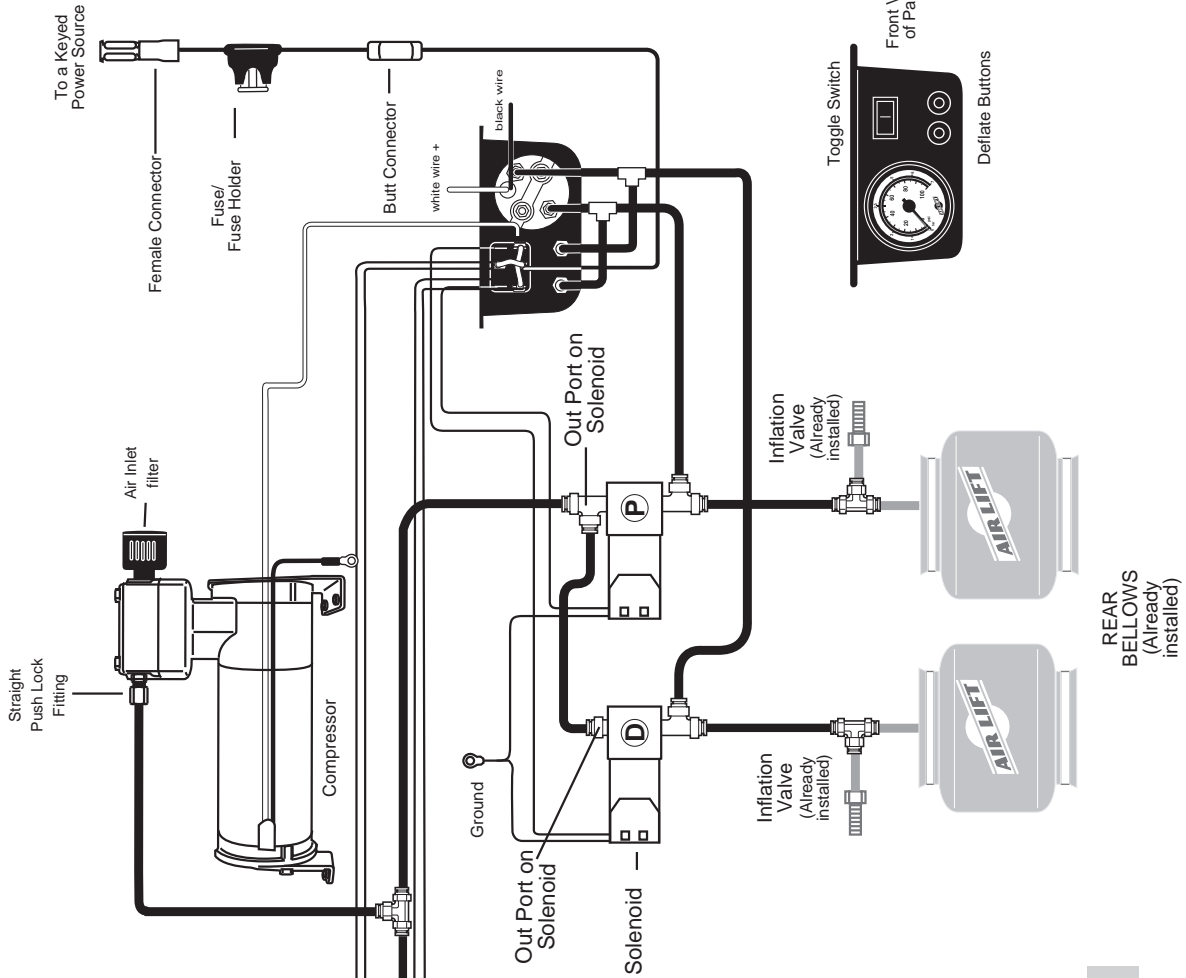

Add-on System

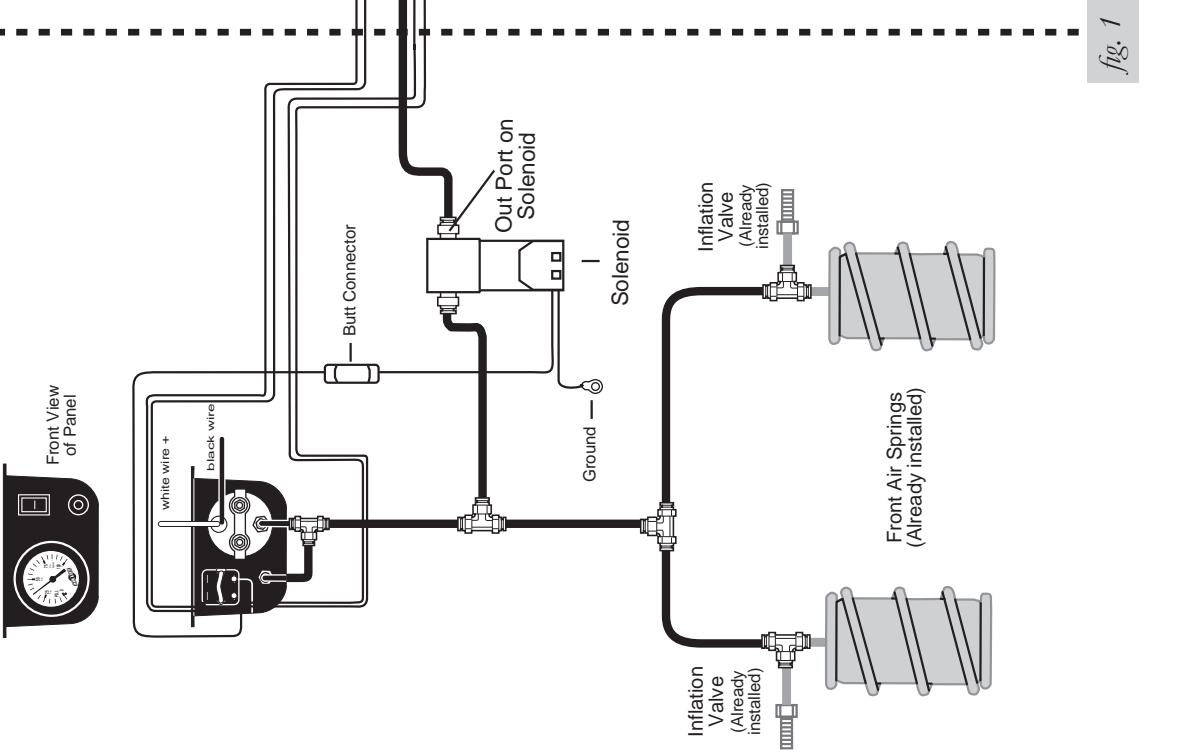

fig. 1

Installing the LoadController System

MOUNTING THE GAUGE PANEL

NOTE

All pre-assembled gauge panels have been 100% leak and function tested. DO NOT attempt to tighten, loosen or adjust any fittings or connections. This will likely cause a leak or malfunction and void the warranty.

1. Select a convenient, sturdy mounting location for the gauge panel, usually next to the existing gauge panel (fig. 2).

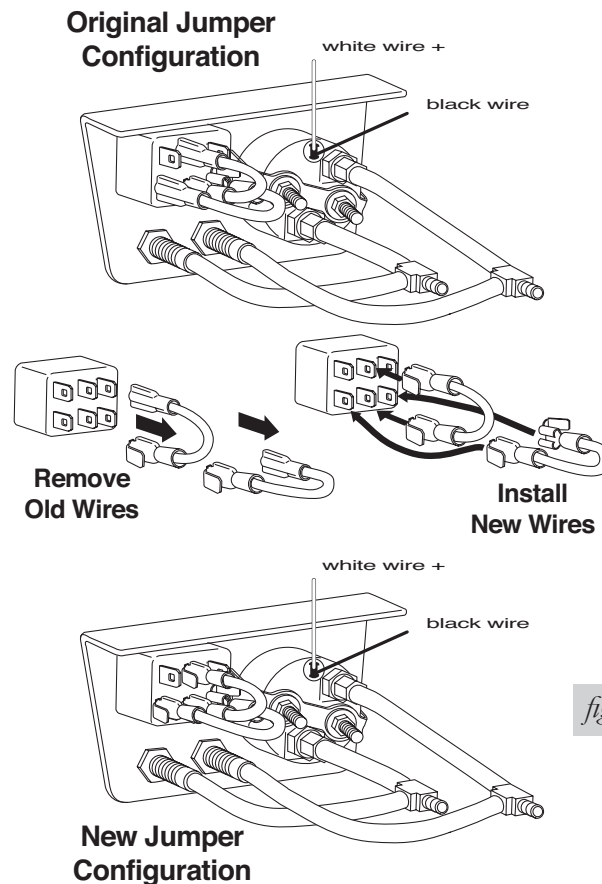

2. Using the gauge panel mounting bracket as a template, mark the mounting screw hole locations. Center punch and drill two 1/8" diameter holes.
3. Position the gauge panel to the mounting surface and secure with 2 self-tapping screws.

MOUNTING THE SOLENOID

1. Insert the two fittings into the solenoids. Tighten securely.
2. Select a convenient mounting location for the solenoid, which provides protection from the elements. Using the body of the solenoid as a template, mark the two holes and center punch and drill two 5/32" holes. Use the #6 x 2" round head machine screws and nuts for mounting.

WIRING THE ELECTRICAL CONNECTIONS

1. Two new jumper wires are provided with this kit to replace the ones on your existing gauge panel. Remove the leads from the compressor and from the power source, noting which terminal on the gauge panel each lead is connected to. Remove the old jumper wires and install the new ones (fig. 2). Connect the leads from the power source and the compressor.
2. Determine the amount of wire needed to connect the gauge panel. Cut and strip the wire, attaching female blade connectors on both ends. Install one end on the male blade connector attached to the top terminal on the original gauge panel, and install the other end on the male blade connector attached to the side terminal on the new gauge panel (fig. 3).

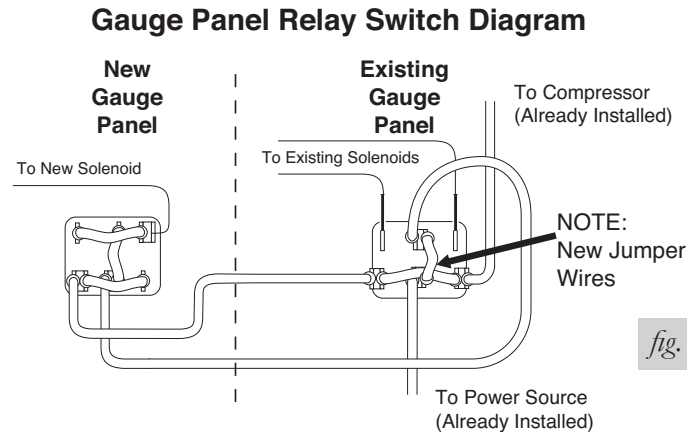

3. Determine the length of the second wire need to connect the 2 panels. Strip both ends and attach female blade connectors, in this case installing them on the male blade connectors on the lower left terminal of the original gauge panel and the lower left terminal of the new gauge panel (fig. 3).
4. Route the small red power wire for the illuminated gauge to an accessory power source. Attach the small black wire to an adequate ground.

CONNECTING THE AIR LINES

1. Remove the air pressure from all air cylinders. Take the core out or use a tire gauge to bleed off the air pressure.

NOTE

Keep air line away from heat (exhaust system, etc.) and moving chassis components. Secure air line to frame with nylon tie straps provided.

2. Use a standard tube cutter, a razor blade, or very sharp knife to cut the air line. A clean square cut will ensure against leaks. Cut the air line already installed between each air cylinder and inflation valve. Install a tee between the two air lines connecting the two air springs (figs. 1 and 4).

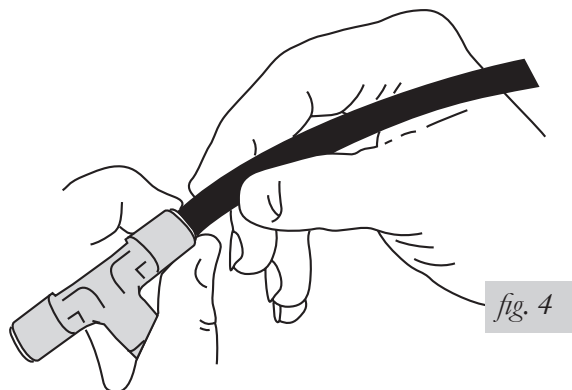

3. Measure the distance from tee to the solenoid. Cut the air line to the proper length and install on last leg of tee previously installed between the air spring and the inflation valve.
4. Route air line coming from both air springs, along the frame and secure with nylon tie straps. Push the air line into one leg of the tee on the solenoid (figs. 4 and 5).

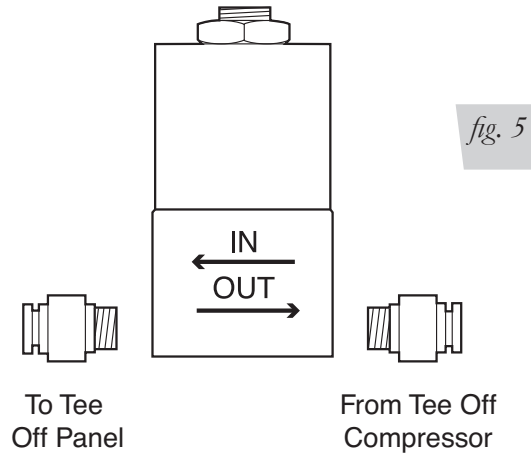

5. Measure distance between solenoid and control panel. Cut sufficient air line and attach one end into last leg of tee on solenoid and route air line to gauge and control panel (fig. 1).
6. Select a point in the air line between the compressor and the original solenoids, at which to install a tee. This will provide air for the new solenoid (fig. 6).

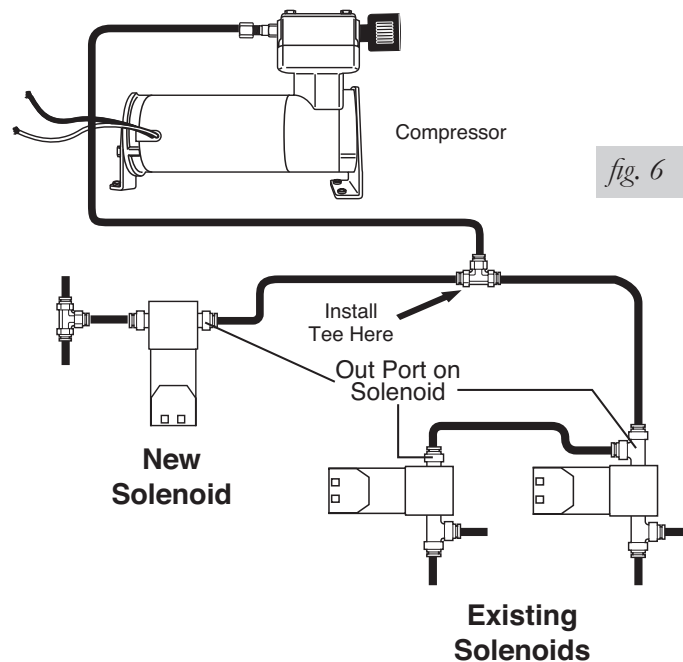

7. Cut the air line and install a tee (fig. 6).
8. Measure distance between the new solenoid and the tee. Cut a length of air line and install one end on the last leg of the tee.
9. Route air line to tee fitting installed in one of the ports in the solenoids. Attach air line as shown in fig. 6. Caution should be used not to kink air line.
10. Turn on ignition switch. Push button in and watch pressure increase on the air gauge. Inflate to 100 PSI Inspect each connection with a soap and water solution. If a leak is found in the barbed fittings, reduce air pressure to zero and tighten threaded connections or remove air line, cut off one inch and reinstall.

Product Use, Maintenance and Servicing

TROUBLESHOOTING GUIDE

Check the inflation pressure weekly, air spring bellows will permeate (loss of pressure through the rubber wall) at the approximate rate of 3-4 PSI per week. Leakage at a higher rate indicates a leak. To find a leak:

1. Inflate the system to 100 PSI
2. Spray all fittings with a solution of 1/5 dish soap to 4/5 water.
 - a. Check inflation valve: valve core and air line connections. If leak is found in the valve core, tighten. It may be replaced with standard tire valve core. Fittings sometime only need tightening.
 - b. Check elbow fitting where threaded into bellows (all threaded connections must have pipe sealant applied) and air line connection. If a leak is found where elbow is threaded into bellows, remove the fitting and clean thoroughly and apply fresh liberal coat of pipe sealant. If a leak is found in the barbed fittings, reduce air pressure to zero and tighten threaded connections or remove air line, cut off one inch, and reinstall.
3. Spray bellows to determine if leak exists. The bellows are not repairable and must be replaced if a leak is found in them.
4. If leak still cannot be found deflate and remove entire unit. Inflate to 15 PSI only and submerge in water.
5. If leakage is suspected in the control panel, inflate the system to 100 PSI and follow steps above. The fittings at the tee and back of the control panel should also be checked with soapy solution. Most leakage can be cured by disassembly, inspection and reassembly of fittings.
6. If compressor fails to function, check 20 amp fuse and ground connection. Repair and replace as necessary.
7. If electric motor runs, but compressor doesn't function check to make sure solenoid valves are opening correctly.

FREQUENTLY ASKED QUESTIONS

Q. Will installing air springs increase the weight ratings of a vehicle?

No. Adding air springs will not change the weight ratings (GAWR, GCWR and/or GVWR) of a vehicle. Exceeding the GVWR is dangerous and voids the Air Lift warranty.

Q. Is it necessary to keep air in the air springs at all times and how much pressure will they need?

For LoadLifter 5000 Ultimate, the recommended minimum air pressure is 5 PSI, but it can safely be run at zero air pressure.

Q. Is it necessary to add a compressor system to the air springs?

No. Air pressure can be adjusted with any type of compressor as long as it can produce sufficient pressure to service the springs. Even a bicycle tire pump can be used, but it's a lot of work.

Q. How long should air springs last?

If the air springs are properly installed and maintained they can last indefinitely.

Q. Will raising the vehicle on a hoist for service work damage the air springs?

No. The vehicle can be lifted on a hoist for short-term service work such as tire rotation or oil changes. However, if the vehicle will be on the hoist for a prolonged period of time, support the axle with jack stands in order to take the tension off of the air springs.

TUNING THE AIR PRESSURE

Pressure determination comes down to three things — level vehicle, ride comfort, and stability.

1. Level vehicle

If the vehicle's headlights are shining into the trees or the vehicle is leaning to one side, then it is not level (fig. 2.1). Raise the air pressure to correct either of these problems and level the vehicle.

2. Ride comfort

If the vehicle has a rough or harsh ride it may be due to either too much pressure or not enough (fig. 2.2). Try different pressures to determine the best ride comfort.

3. Stability

Stability translates into safety and should be the priority, meaning the driver may need to sacrifice a perfectly level and comfortable ride. Stability issues include roll control, bounce, dive during braking and sponginess (fig. 2.3). Tuning out these problems usually requires an increase in pressure.



Bad headlight aim

fig. 2.1



Rough ride

fig. 2.2

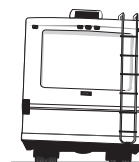

Sway and
body roll

fig. 2.3

GUIDELINES FOR ADDING AIR

1. Start with the vehicle level or slightly above.
2. When in doubt, always add air.
3. If the front of the vehicle dives while braking, increase the pressure in the front air bags, if equipped.
4. If it is ever suspected that the air bags have bottomed out, increase the pressure (fig. 2.4).
5. Adjust the pressure up and down to find the best ride.
6. If the vehicle rocks and rolls, adjust the air pressure to reduce movement.
7. It may be necessary to maintain different pressures on each side of the vehicle. Loads such as water, fuel, and appliances will cause the vehicle to be heavier on one side (fig. 2.5). As much as a 50 PSI difference is not uncommon.



Bottoming out

fig. 2.4

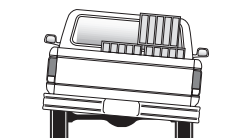

Unlevel

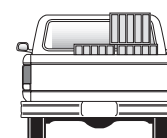

Level

fig. 2.5

Warranty and Returns Policy

Air Lift Company warrants its products, for the time periods listed below, to the original retail purchaser against manufacturing defects when used on catalog-listed applications on cars, vans, light trucks and motorhomes under normal operating conditions for as long as Air Lift manufactures the product. The warranty does not apply to products that have been improperly applied, improperly installed, used in racing or off-road applications, used for commercial purposes, or which have not been maintained in accordance with installation instructions furnished with all products. The consumer will be responsible for removing (labor charges) the defective product from the vehicle and returning it, transportation costs prepaid, to the dealer from which it was purchased or to Air Lift Company for verification.

Air Lift will repair or replace, at its option, defective products or components. A minimum \$10.00 shipping and handling charge will apply to all warranty claims. Before returning any defective product, you must call Air Lift at (800) 248-0892 in the U.S. and Canada (elsewhere, (517) 322-2144) for a Returned Materials Authorization (RMA) number. Returns to Air Lift can be sent to: Air Lift Company • 2727 Snow Road • Lansing, MI • 48917.

Product failures resulting from abnormal use or misuse are excluded from this warranty. The loss of use of the product, loss of time, inconvenience, commercial loss or consequential damages is not covered. The consumer is responsible for installation/reinstallation (labor charges) of the product. Air Lift Company reserves the right to change the design of any product without assuming any obligation to modify any product previously manufactured.

This warranty gives you specific legal rights and you may also have other rights that vary from state-to-state. Some states do not allow limitations on how long an implied warranty lasts or allow the exclusion or limitation of incidental or consequential damages. The above limitation or exclusion may not apply to you. There are no warranties, expressed or implied including any implied warranties of merchantability and fitness, which extend beyond this warranty period. There are no warranties that extend beyond the description on the face hereof. Seller disclaims the implied warranty of merchantability. (Dated proof of purchase required.)

Air Lift 1000™	Lifetime Limited	LoadController/Dual™	2 Year Limited
RideControl™	Lifetime Limited	Load Controller™ (I)	2 Year Limited
LoadLifter 5000™*	Lifetime Limited	Load Controller™ (II)	2 Year Limited
LoadLifter 5000™ Ultimate ...	Lifetime Limited	SmartAir™	2 Year Limited
SlamAir™	Lifetime Limited	Wireless AIR™	2 Year Limited
AirCell™	Lifetime Limited	WirelessONE™	2 Year Limited
Air Lift Performance™**	1 Year Limited	Other Accessories	2 Year Limited
LoadController/Single™	2 Year Limited		

**formerly SuperDuty*

***formerly LifeSTYLE & Performance, EasyStreet*

Replacement Information

If you need replacement parts, contact the local dealer or call Air Lift customer service at (800) 248-0892. Most parts are immediately available and can be shipped the same day.

Contact Air Lift Company customer service at (800) 248-0892, first if:

- Parts are missing from the kit.
- Need technical assistance on installation or operation.
- Broken or defective parts in the kit.
- Wrong parts in the kit.
- Have a warranty claim or question.

Contact the retailer where the kit was purchased:

- If it is necessary to return or exchange the kit for any reason.
- If there is a problem with shipping if shipped from the retailer.
- If there is a problem with the price.

Contact Information

If you have any questions, comments or need technical assistance, contact our customer service department by calling (800) 248-0892, Monday through Friday. For calls from outside the USA or Canada, our local number is (517) 322-2144.

For inquiries by mail, our address is PO Box 80167, Lansing, MI 48908-0167. Our shipping address for returns is 2727 Snow Road, Lansing, MI 48917.

You may also contact us anytime by e-mail at sales@airliftcompany.com or on the web at www.airliftcompany.com.

Template

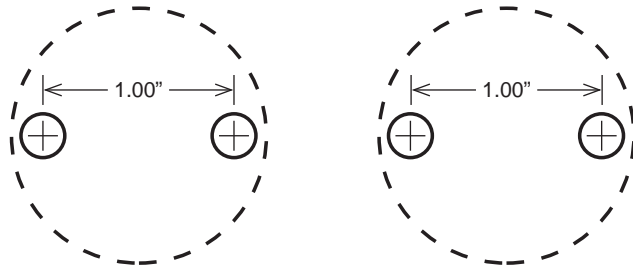



Notes

Notes

Need Help?

Contact our customer service department by calling (800) 248-0892, Monday through Friday. For calls from outside the USA or Canada, our local number is (517) 322-2144.

**Register your warranty online at
www.airliftcompany.com/warranty**



Thank you for purchasing Air Lift products — the professional installer's choice!

Air Lift Company • 2727 Snow Road • Lansing, MI 48917 or PO Box 80167 • Lansing, MI 48908-0167
Toll Free (800) 248-0892 • Local (517) 322-2144 • Fax (517) 322-0240 • www.airliftcompany.com

Printed in
the USA