

LoadLIFTER™ 5000

by AIR LIFT®

Kit 57289

Dodge Ram 2500HD



INSTALLATION GUIDE

For maximum effectiveness and safety, please read these instructions completely before proceeding with installation.

Failure to read these instructions can result in an incorrect installation.

TABLE OF CONTENTS

Introduction	2
Important Safety Notice	2
Notation Explanation	2
Installation Diagram	3
Hardware and Tools Lists	4
Installing the LoadLifter 5000 System	5
Getting Started	5
Assembling the Air Spring Assemblies	7
Finished Assemblies	9
Attaching the Assemblies to the Frame	9
Installing the Air Lines	11
Finished Installation Photos	12
Checking for Leaks	14
Fixing Leaks	14
Before Operating	15
Installation Checklist	15
Post-Installation Checklist	15
Product Use, Maintenance and Servicing	16
Minimum and Maximum Pressure	16
Maintenance Guidelines	16
Troubleshooting Guide	16
Frequently Asked Questions	17
Tuning the Air Pressure	17
Guidelines for Adding Air	18
Choosing the Right On-Board Air Compressor System . . .	19
Limited Warranty and Return Policy	20
Replacement Information	21
Contact Information	21

Introduction

The purpose of this publication is to assist with the installation, maintenance and troubleshooting of the LoadLifter 5000 air spring kit. LoadLifter 5000 utilizes sturdy, reinforced, commercial grade single or double, depending on the kit, convolute bellows. The bellows are manufactured like a tire with layers of rubber and cords that control growth. LoadLifter 5000 kits are recommended for most 3/4 and 1 ton pickups and SUVs with leaf springs and provide up to 5,000 lbs. of load-leveling support with air adjustability from 5-100 PSI. The kits are used in motor home rear applications and various front applications where leaf springs are used.

It is important to read and understand the entire installation guide before beginning installation or performing any maintenance, service or repair. The information here includes a hardware list, tool list, step-by-step installation information, maintenance guidelines and operating tips.

Air Lift Company reserves the right to make changes and improvements to its products and publications at any time. For the latest version of this manual, contact Air Lift Company at (800) 248-0892 or visit our website at www.airliftcompany.com.

IMPORTANT SAFETY NOTICE

The installation of this kit does not alter the Gross Vehicle Weight Rating (GVWR) or payload of the vehicle. Check your vehicle's owner's manual and do not exceed the maximum load listed for your vehicle.

Gross Vehicle Weight Rating: The maximum allowable weight of the fully loaded vehicle (including passengers and cargo). This number — along with other weight limits, as well as tire, rim size and inflation pressure data — is shown on the vehicle's Safety Compliance Certification Label.

Payload: The combined, maximum allowable weight of cargo and passengers that the truck is designed to carry. Payload is GVWR minus the Base Curb Weight.

NOTATION EXPLANATION

Hazard notations appear in various locations in this publication. Information which is highlighted by one of these notations must be observed to help minimize risk of personal injury or possible improper installation which may render the vehicle unsafe. Notes are used to help emphasize areas of procedural importance and provide helpful suggestions. The following definitions explain the use of these notations as they appear throughout this guide.

 **DANGER**

INDICATES IMMEDIATE HAZARDS WHICH WILL RESULT IN SEVERE PERSONAL INJURY OR DEATH.

 **WARNING**

INDICATES HAZARDS OR UNSAFE PRACTICES WHICH COULD RESULT IN SEVERE PERSONAL INJURY OR DEATH.

 **CAUTION**

INDICATES HAZARDS OR UNSAFE PRACTICES WHICH COULD RESULT IN DAMAGE TO THE MACHINE OR MINOR PERSONAL INJURY.

NOTE

Indicates a procedure, practice or hint which is important to highlight.

Installation Diagram

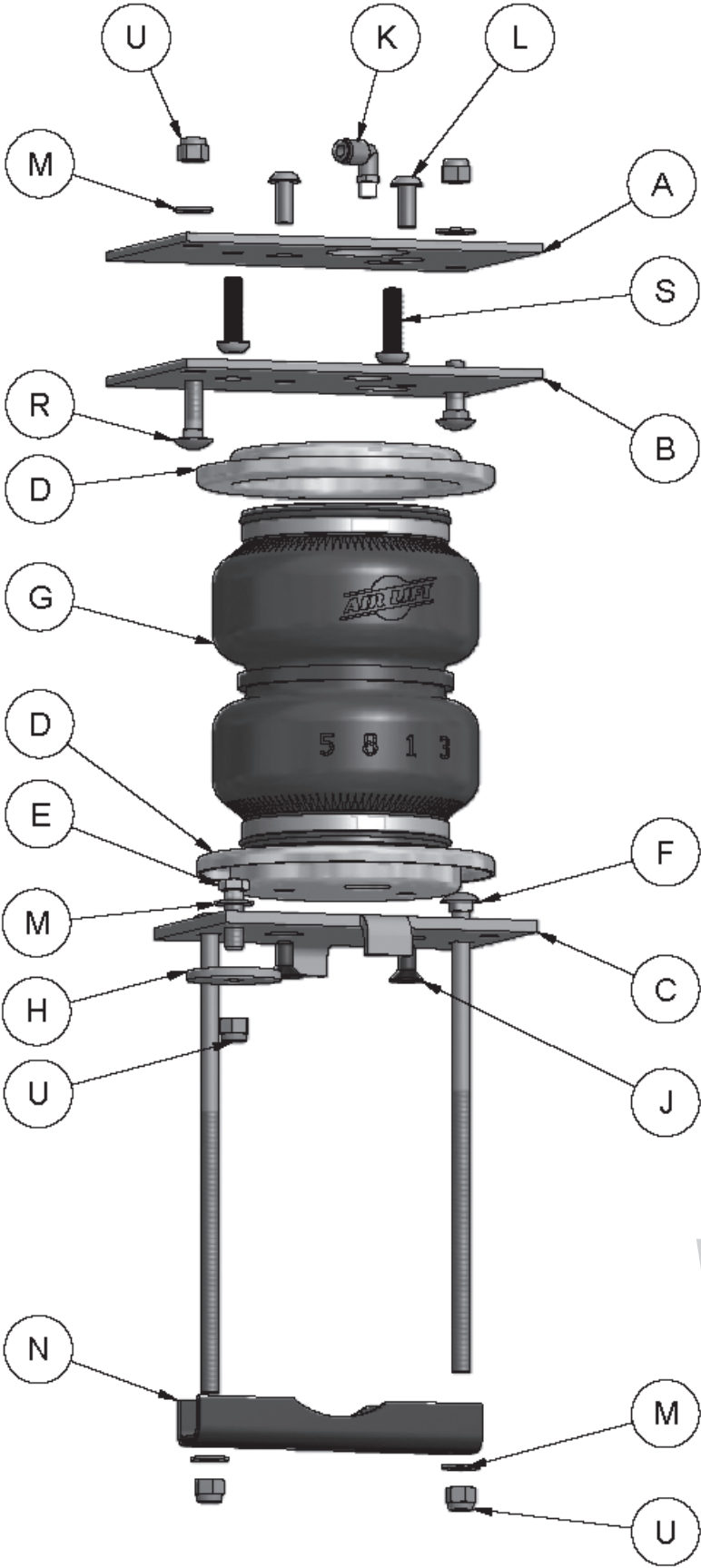

fig. 1

Hardware and Tools Lists

HARDWARE LIST

Item	Part #	Description	Qty	Item	Part #	Description	Qty
A	07160	Upper Frame Bracket.....	2	AA*	20086	Air Line Assembly	1
B	07161	Upper Air Spring Bracket.....	2	BB*	10466	Zip Ties	6
C	03019	Lower Bracket.....	2	CC*	21230	Valve Caps.....	2
D	11951	Roll Plate.....	4	DD*	18501	5/16" Flat Washer	2
E	17188	3/8"-16 X 1.25" Hex Head Bolt.....	2	EE*	21234	Rubber Washer.....	2
F	17387	3/8"-16 X 10" Carriage Bolt.....	4	FF*	18411	Star Washer.....	2
G	58437	Air Spring	2	GG*	21233	5/16" Hex Nut.....	4
H	18260	Large Flat Washer	2				
J	17215	3/8"-24 X 3/4" Flat Head Screw	4				
K	21837	90° Swivel Fitting	2				
L	17365	3/8"-24 X 7/8" Button Head Screw	4				
M	18444	3/8" Flat Washer	10				
N	01531	Clamp Bar	2				
R	17361	3/8"-16 X 1.25" Carriage Bolt.....	4				
S	17366	M10-1.5" Button Head Screw.....	4				
U	18435	3/8"-16 Nyloc Nut.....	10				

*Not shown

TOOLS LIST

Description.....	Qty
9/16" Crows Foot Adapter	1
Standard Open-end Combo Wrenches	1
Ratchet	1
5/16" drill bits (very sharp).....	1
Metric and Standard Sockets	1
Heavy duty drill.....	1
Torque wrench.....	1
#6 Metric Allen Wrench (socket if available).....	1
7/32" Allen Wrench (socket if available)	1
Hose cutter, razor blade, or sharp knife	1
Hoist or floor jacks.....	1
Safety stands.....	2
Safety glasses	1
Air compressor or compressed air source.....	1
Spray bottle with dish soap/water solution	1



Missing or damaged parts? Call Air Lift customer service at (800) 248-0892 for a replacement part.

Installing the LoadLifter 5000 System

GETTING STARTED

1. Raise the vehicle and support the frame with jack stands, drop the axle down to make room for the air spring assemblies to be put into position between the frame and axle (Fig. 2).

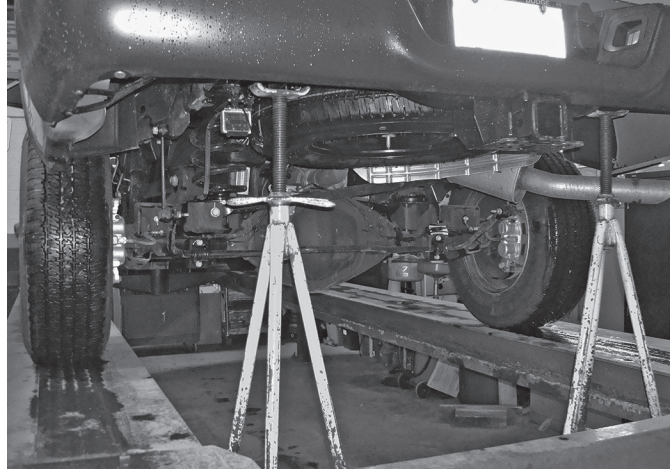

fig. 2

2. On the left side (driver) axle there is a small vent tube (Fig. 3) that needs to be tied on an angle with a Zip Tie (BB).

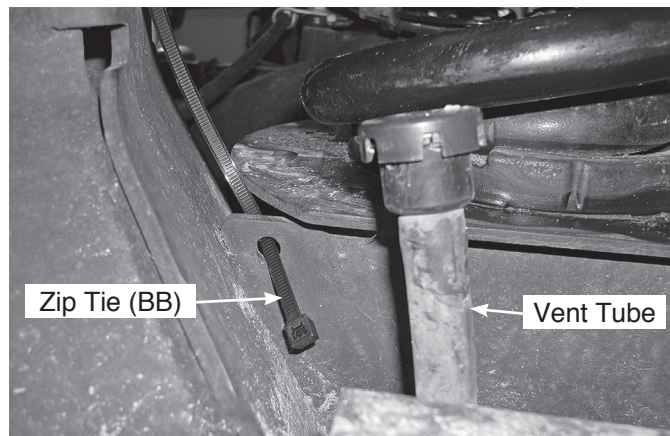

fig. 3

3. Insert the Zip Tie (BB) into the small hole in the lower coil spring seat, then around the vent tube and just snug the zip tie enough to angle the tube out of the way (Fig. 4).

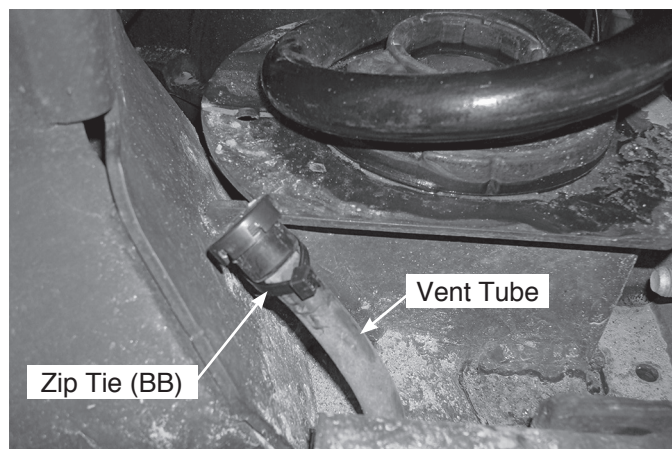
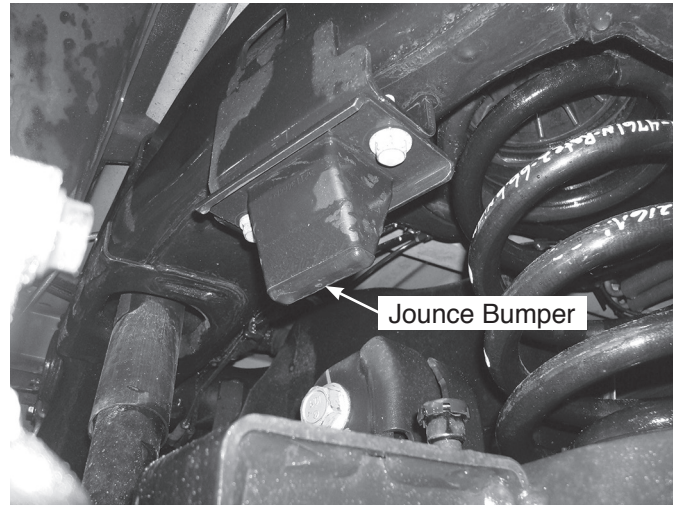
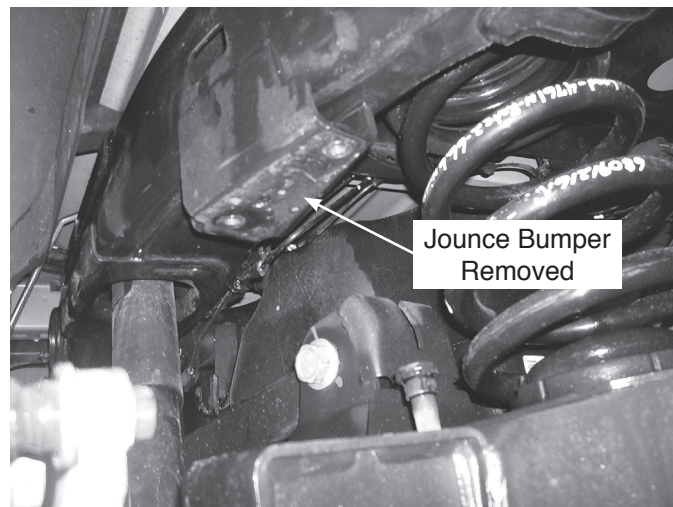

fig. 4

- Remove the left and right side jounce bumpers (Figs. 5 & 6).

fig. 5

fig. 6

- Attach the upper frame bracket (A) to the frame (Figs. 7 & 8) using the M10 button head screws (S).

NOTE

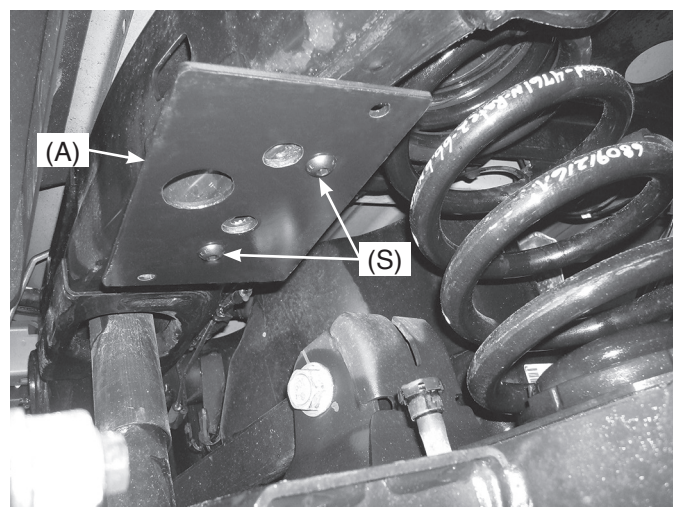
The large hole in the bracket goes to the outside of the frame (toward the tire).



Driver Side
Shown

fig. 7

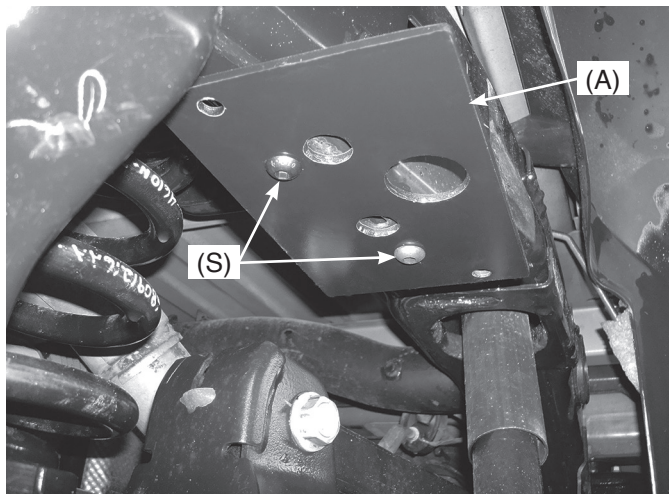

Passenger Side Shown

fig. 8

6. Torque the mounting hardware to 30 lb.-ft.

ASSEMBLING THE AIR SPRING ASSEMBLIES

1. Set a roll plate (D) over the top of each air spring (G).

NOTE

The radiused (rounded) edge of the roll plate (D) will be towards the air spring so that the air spring is seated inside both roll plates.

2. Install the swivel fitting (K) into the top of the air spring finger tight plus one and a half turns (Fig. 9). Repeat for both air springs.

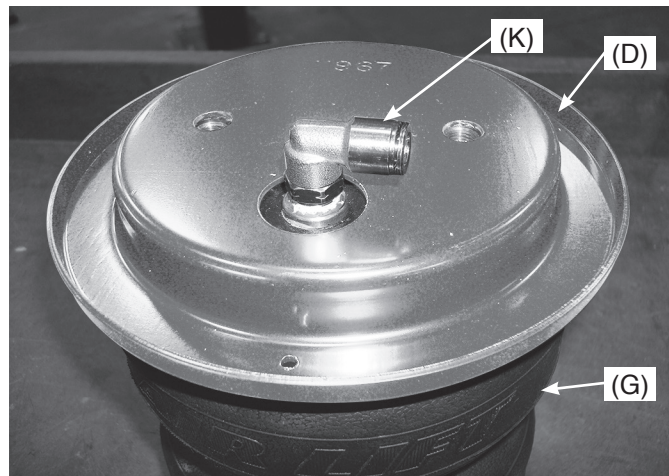

fig. 9

3. Set both air springs in front of you with the fittings pointing at you (Fig. 10).
4. Insert the 3/8" carriage bolt (R) through the upper air spring bracket (B) in the hole at the back side only (Figs. 1 & 10).

NOTE

The upper air spring brackets will be a mirror image when set onto the air springs (see Fig. 10).

Left Hand Side (Driver) Assembly

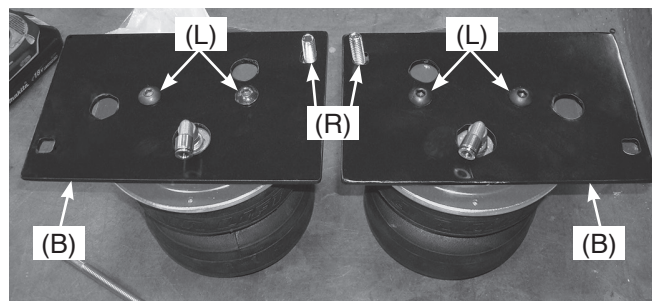

Right Hand Side (Passenger) Assembly

fig. 10

5. Set both brackets onto the air springs and attach using the 3/8" button head screws (L). Torque no more than 20 lb.-ft.
6. Install the thick 3/8" flat washer (H) onto the lower bracket (C) with 3/8" hex head bolt (E), 3/8" flat washer (M) and 3/8" nyloc nut (U) as shown (Figs. 1 & 11). Tighten securely.
7. Insert the long 3/8" carriage bolts (F) into the square holes in the lower bracket opposite side of the flanges (Figs. 1 & 11).

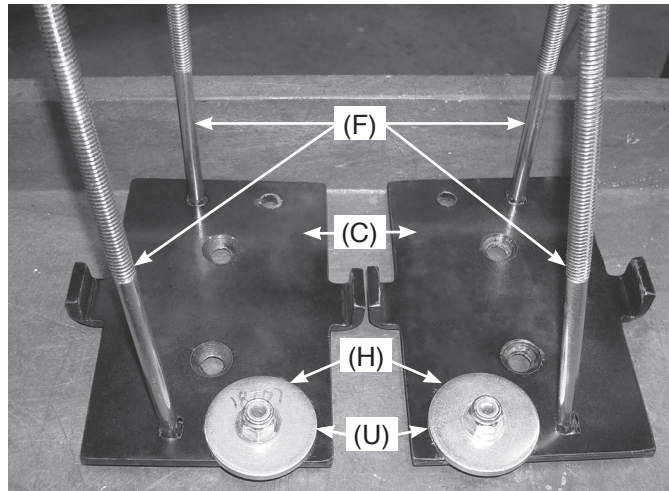

fig. 11

8. Set a roll plate (D) over the bottom of the air spring and install the lower brackets onto the air spring assembly so that the large washer previously installed will be forward of the axle once installed (Figs. 12 & 13) using the 3/8" flat head screws (J). Torque to no more than 20 lb.-ft.

Left Hand Side
(Driver) Assembly

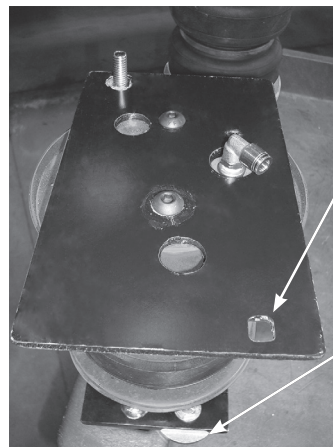
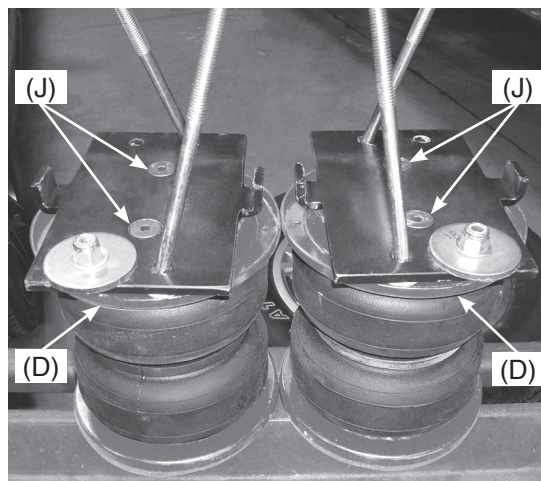

fig. 12

- Make sure the lower bracket attached with the large washer is on the same side as the open square hole in the top bracket as shown.
- The large washer installed on the lower bracket will be forward of the axle once installed.

Left Hand Side
(Driver) Assembly

See Figures 8 and 10 to position correctly on the assembly.



Right Hand Side
(Passenger)
Assembly

See Figures 8 and 10 to position correctly on the assembly.

fig. 13

FINISHED ASSEMBLIES

Left Hand Side
(Driver) shown

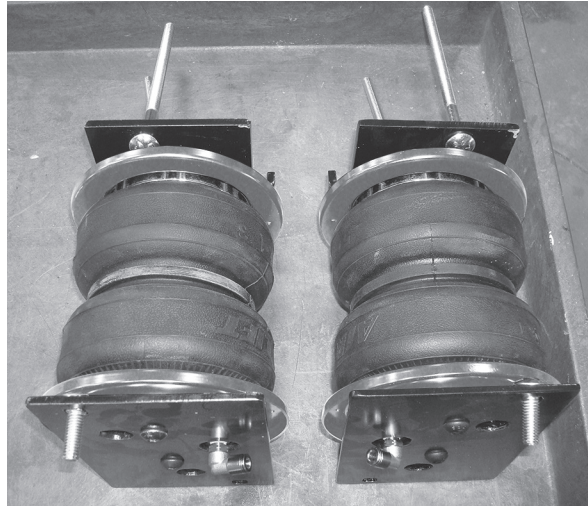

Right Hand Side
(Passenger)
shown

fig. 14

ATTACHING THE ASSEMBLIES TO THE FRAME

1. With the axle slightly hanging, set the left side (driver) assembly on the axle making sure that the carriage bolt (F) goes in between the brake line and the axle (Fig. 15).

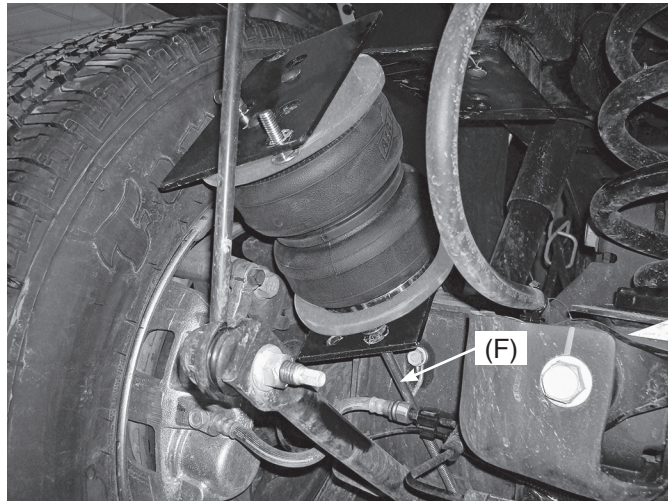

fig. 15

2. Carefully set the upper air spring bracket into position making sure that the carriage bolt and fitting line up with the holes in the frame bracket (Fig. 16). Raise the axle up so that the brackets come together making sure the fitting and the carriage bolt go through the holes and do not bind.

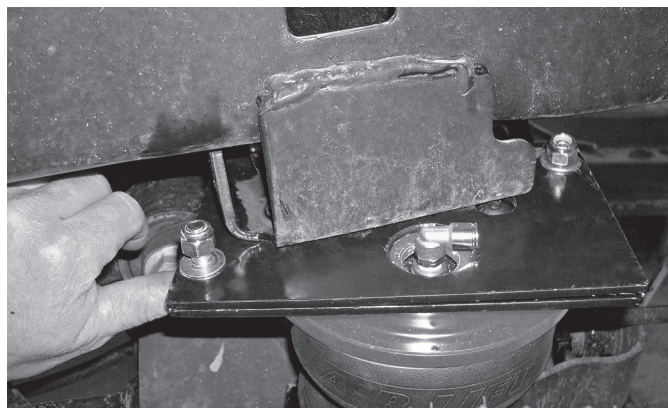

fig. 16

3. Insert the remaining Carriage Bolt (R) through the open front holes from the bottom up and cap both upper carriage bolts with 3/8" flat washer (M) and 3/8" nyloc nut (U). Torque to 16 lb.-ft. Repeat for the other side.

NOTE

It may be necessary to use a 9/16" crows foot adapter to torque the nut underneath the frame.

4. Bring the axle all the way up and position the lower bracket over the lower jounce bumper strike plate so that the large washer on the bottom of the bracket is forward and over the lower jounce bumper strike plate (Fig. 17).

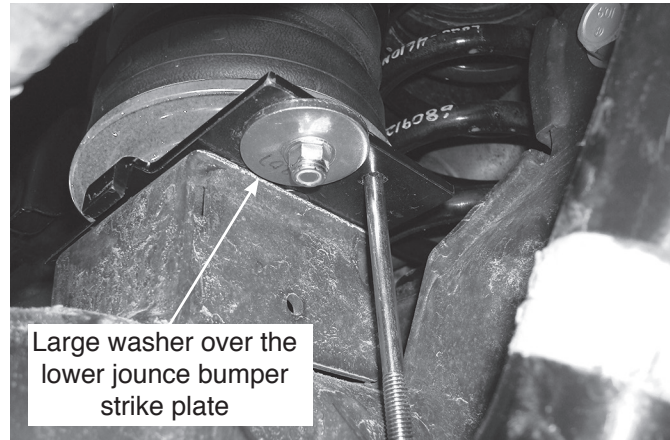

Large washer over the lower jounce bumper strike plate

Right Hand Side (Passenger) shown

fig. 17

5. Set the clamp bar (N) over the two long carriage bolts (F) under the axle and cap with two 3/8" flat washers (M) and 3/8" nyloc nut (U) (Fig. 18).

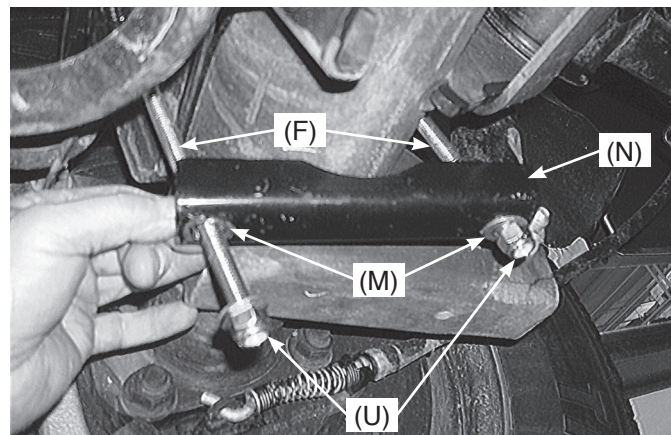

fig. 18

6. Torque evenly to 10 lb.-ft. (Fig. 19). Repeat for the other side.

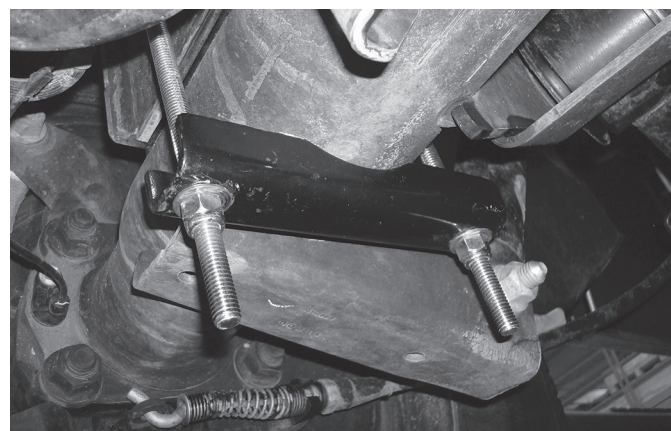

fig. 19

7. Raise the axle or lower the vehicle and remove the jack stands.

INSTALLING THE AIR LINES

1. Choose a convenient location for mounting the inflation valves. Popular locations for the inflation valve are:
 - a. The wheel well flanges
 - b. The license plate recess in bumper
 - c. Under the gas cap access door
 - d. Through the license plate

NOTE

Whatever the chosen location, make sure there is enough clearance around the inflation valves for an air chuck.

2. Drill two 5/16" holes to install the inflation valves.
3. Cut the air line assembly in two equal lengths.

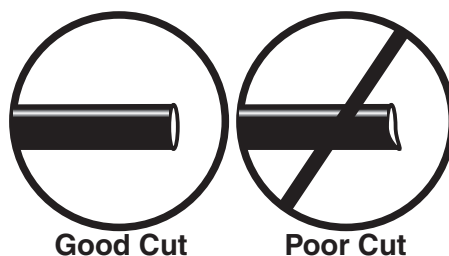

fig. 20

CAUTION

WHEN CUTTING OR TRIMMING THE AIR LINE, USE A HOSE CUTTER, A RAZOR BLADE, OR A SHARP KNIFE. A CLEAN, SQUARE CUT WILL ENSURE AGAINST LEAKS. DO NOT USE WIRE CUTTERS OR SCISSORS TO CUT THE AIR LINE. THESE TOOLS MAY FLATTEN OR CRIMP THE AIR LINE CAUSING IT TO LEAK AROUND THE O-RING SEAL INSIDE THE ELBOW FITTING (FIG. 20).

4. Place a 5/16" nut and star washer on the air valve. Leave enough of the inflation valve in front of the nut to extend through the hole and have room for the rubber washer, flat washer, and 5/16" nut and cap. There should be enough valve exposed after installation—approximately 1/2"— to easily apply a pressure gauge or an air chuck (Fig. 21).

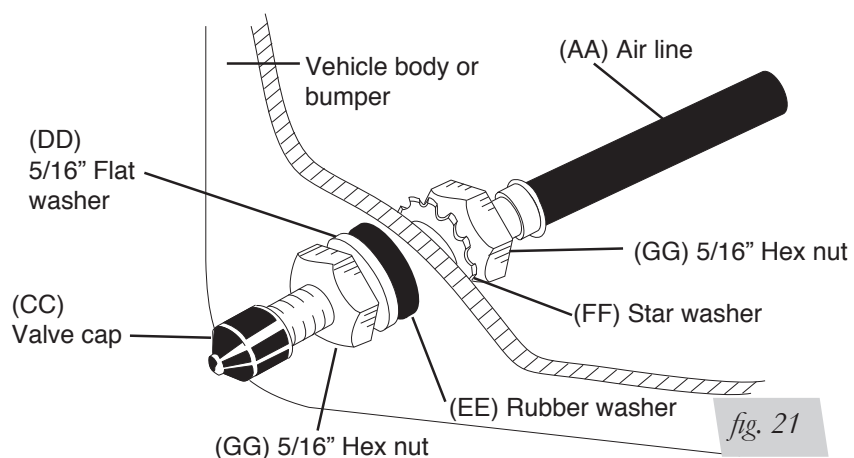
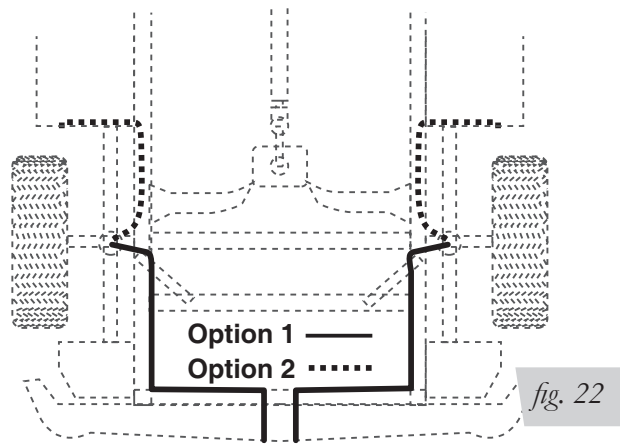

fig. 21

5. Push the inflation valve through the hole and use the rubber washer, flat washer, and another 5/16" nut to secure it in place. Tighten the nuts to secure the assembly.
6. Route the air line along the frame to the air fitting on the air spring (Fig. 22). Keep AT LEAST 6" of clearance between the air line and heat sources, such as the exhaust pipes, muffler, or catalytic converter. Avoid sharp bends and edges. Use the plastic tie straps to secure the air line to fixed, non-moving points along the chassis. Be sure that the tie straps are tight, but do not pinch the air line. Leave at least 2" of slack to allow for any movement that might pull on the air line.



- Cut off the air line, leaving approximately 12" of extra air line. A clean square cut will ensure against leaks. Insert the air line into the air fitting. This is a push-to-connect fitting. Simply push the air line into the 90° swivel fitting until it bottoms out (9/16" of air line should be in the fitting).

FINISHED INSTALLATION PHOTOS

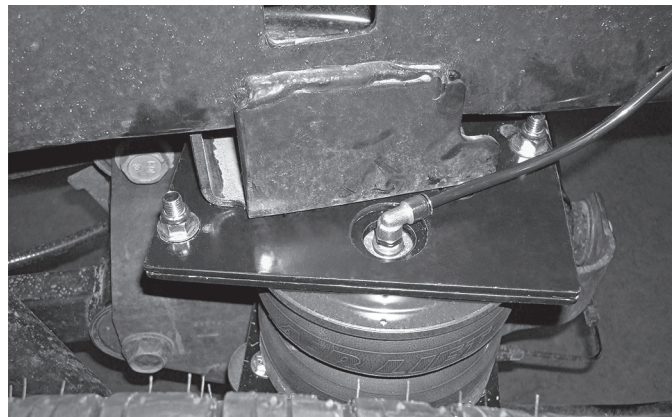

fig. 23

Left side (driver) top view

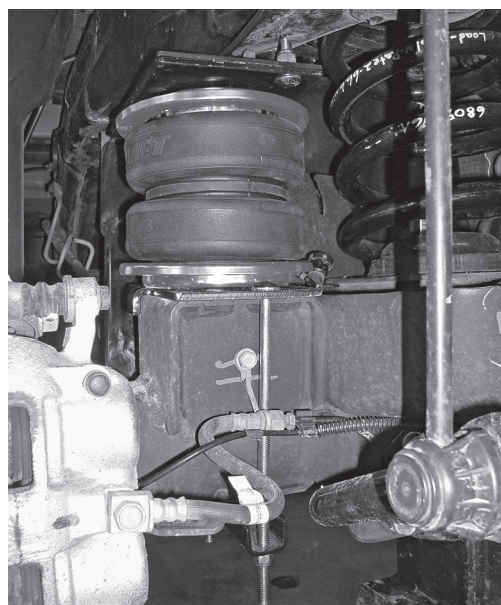

fig. 24

Left side (driver) back view shown with tire removed

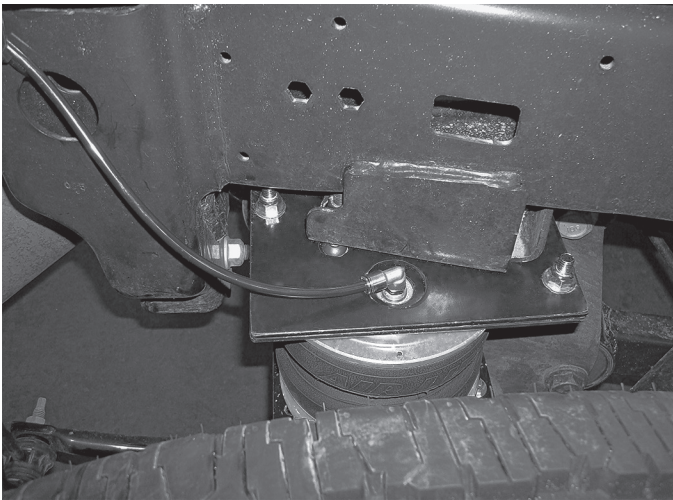

fig. 25

Right side (passenger) top view

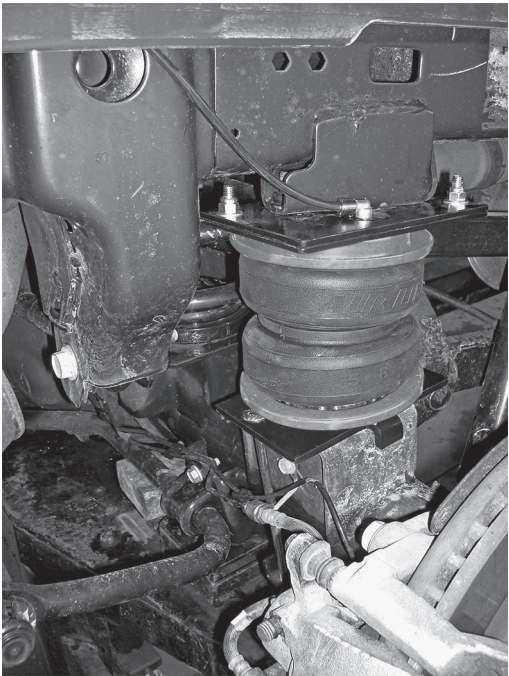

fig. 26

Right side (passenger) view shown with tire removed

CHECKING FOR LEAKS

1. Inflate the air spring to 30 PSI.
2. Spray all connections and the inflation valves with a solution of 1/5 liquid dish soap and 4/5 water. Spot leaks easily by looking for bubbles in the soapy water.
3. After the test, deflate the springs to the minimum pressure required to restore the system to normal ride height. Do not deflate to lower than 5 PSI.
4. Check the air pressure again after 24 hours. A 2 - 4 PSI loss after initial installation is normal. Retest for leaks if the loss is more than 5 lbs.

FIXING LEAKS

1. If there is a problem with the swivel fitting:
 - a. Check the air line connection by deflating the spring and removing the line by pulling the collar against the fitting and pulling firmly on the air line. Trim 1" off the end of the air line. Be sure the cut is clean and square (see Fig. 12). Reinsert the air line into the push-to-connect fitting.
 - b. Check the threaded connection by tightening the swivel fitting another 1/2 turn. If it still leaks, deflate the air spring, remove the fitting, and re-coat the threads with thread sealant. Reinstall by hand tightening as much as possible and then use a wrench for an additional two turns.
2. If there is a problem with the inflation valve:
 - a. Check the valve core by tightening it with a valve core tool.
 - b. Check the air line by removing the air line from the barbed type fitting. Cut the air line off a few inches in front of the fitting and use a pair of pliers or vice grips to pull/twist the air line off of the fitting.

 **CAUTION**

DO NOT CUT OFF THE AIR LINE COMPLETELY AS THIS WILL USUALLY NICK THE BARB AND RENDER THE FITTING USELESS.

3. If the preceding steps have not resolved the problem, call Air Lift customer service at (800) 248-0892.

Before Operating

INSTALLATION CHECKLIST (To be completed by installer)

- Clearance test — Inflate the air springs to 60 PSI and ensure there is at least 1/2" clearance around each bellow, away from anything that might rub against them. Be sure to check the tire, brake drum, frame, shock absorbers and brake cables.
- Leak test before road test — Inflate the air springs to 60 PSI, check all connections for leaks with a soapy water solution. See the *Checking for Leaks* section for tips on how to spot leaks. All leaks must be eliminated before the vehicle is road tested.
- Heat test — Be sure there is sufficient clearance from any heat sources — at least 6" for air springs and air lines. If a heat shield was included in the kit, install it. If there is no heat shield, but one is required, call (800) 248-0892.
- Fastener test — Recheck all bolts for proper torque. Re-torque after 100 miles.
- Road test — The vehicle should be road tested after the preceding tests. Inflate the air springs to 25 PSI (50 PSI if the vehicle is loaded). Drive the vehicle 10 miles and recheck for clearance, loose fasteners and air leaks.
- Operating instructions — If professionally installed, the installer should review the *Product Use, Maintenance and Servicing* section with the owner. Be sure to provide the owner with all of the paperwork which came with the kit.

Technician's Signature _____

Date _____

POST-INSTALLATION CHECKLIST

- Overnight leak down test — Recheck air pressure after the vehicle has been used for 24 hours. If the pressure has dropped more than 5 PSI, then there is a leak that must be fixed. Either fix the leak yourself or return to the installer for service.
- Air pressure requirements — Regardless of load, the air pressure should always be adjusted to maintain ride height at all times.
- Thirty day or 500 mile test — Recheck the air spring system after 30 days or 500 miles, whichever comes first. If any part shows signs of rubbing or abrasion, the source should be identified and moved, if possible. If it is not possible to relocate the cause of the abrasion, the air spring may need to be remounted. If professionally installed, the installer should be consulted. Check all fasteners for tightness.

Product Use, Maintenance and Servicing

Minimum Recommended Pressure	Maximum Air Pressure
5 PSI	100 PSI

MAINTENANCE GUIDELINES

NOTE

By following the steps below, vehicle owners will obtain the longest life and best results from their air springs.

1. Check the air pressure weekly.
2. Always maintain normal ride height. Never inflate beyond 100 PSI.
3. If you develop an air leak in the system, use a soapy water solution (1/5 liquid dish soap and 4/5 water) to check all air line connections and the inflation valve core before deflating and removing the air spring.

CAUTION

FOR YOUR SAFETY AND TO PREVENT POSSIBLE DAMAGE TO YOUR VEHICLE, DO NOT EXCEED MAXIMUM GROSS VEHICLE WEIGHT RATING (GVWR), AS INDICATED BY THE VEHICLE MANUFACTURER. ALTHOUGH YOUR AIR SPRINGS ARE RATED AT A MAXIMUM INFLATION PRESSURE OF 100 P.S.I., THE AIR PRESSURE ACTUALLY NEEDED IS DEPENDANT ON YOUR LOAD AND GVWR.

4. Loaded vehicles require at least 25 PSI or more. A “loaded vehicle” refers to a vehicle with a heavy bed load, a trailer, or both. As discussed above, never exceed GVWR, regardless of air spring, air pressure, or other load assist. The springs in this kit will support approximately 40 lbs. of load (combined on both springs) for each 1 PSI of pressure. The required air pressure will vary depending on the state of the original suspension. Operating the vehicle below the minimum air spring pressure will void the Air Lift warranty.
5. When increasing load, always adjust the air pressure to maintain the normal ride height. Increase or decrease pressure from the system as necessary to attain normal ride height for optimal ride and handling. Remember that loads carried behind the axle (including tongue loads) require more leveling force (pressure) than those carried directly over the axle.
6. Always add air to springs in small quantities, checking the pressure frequently.
7. Should it become necessary to raise the vehicle by the frame, make sure the system is at minimum pressure (5 PSI) to reduce the tension on the suspension/brake components. Use of on board leveling systems do not require deflation or disconnection.
8. Periodically check the air spring system fasteners for tightness. Also, check the air springs for any signs of rubbing. Realign if necessary.
9. On occasion, give the air springs a hard spray with a garden hose in order to remove mud, sand, gravel or other abrasive debris.

TROUBLESHOOTING GUIDE

1. Leak test the air line connections, the threaded connection into the air spring, and all fittings in the control system.
2. Inspect the air lines to be sure none are pinched. Tie straps may be too tight. Loosen or replace the strap and replace leaking components.
3. Inspect the air line for holes and cracks. Replace as needed.
4. Look for a kink or fold in the air line. Reroute as needed.

If the preceding steps do not solve the problem, it is possibly caused by a failed air spring — either a factory defect or an operating problem. Please call Air Lift at (800) 248-0892 for assistance.

FREQUENTLY ASKED QUESTIONS

Q. Will installing air springs increase the weight ratings of a vehicle?

No. Adding air springs will not change the weight ratings (GAWR, GCWR and/or GVWR) of a vehicle. Exceeding the GVWR is dangerous and voids the Air Lift warranty.

Q. Is it necessary to keep air in the air springs at all times and how much pressure will they need?

For LoadLifter 5000 Ultimate, the recommended minimum air pressure is 5 PSI, but it can safely be run at zero air pressure.

Q. Is it necessary to add a compressor system to the air springs?

No. Air pressure can be adjusted with any type of compressor as long as it can produce sufficient pressure to service the springs. Even a bicycle tire pump can be used, but it's a lot of work.

Q. How long should air springs last?

If the air springs are properly installed and maintained they can last indefinitely.

Q. Will raising the vehicle on a hoist for service work damage the air springs?

No. The vehicle can be lifted on a hoist for short-term service work such as tire rotation or oil changes. However, if the vehicle will be on the hoist for a prolonged period of time, support the axle with jack stands in order to take the tension off of the air springs.

TUNING THE AIR PRESSURE

Pressure determination comes down to three things — level vehicle, ride comfort, and stability.

1. Level vehicle

If the vehicle's headlights are shining into the trees or the vehicle is leaning to one side, then it is not level (Fig. 2.1). Raise the air pressure to correct either of these problems and level the vehicle.

2. Ride comfort

If the vehicle has a rough or harsh ride it may be due to either too much pressure or not enough (Fig. 2.2). Try different pressures to determine the best ride comfort.

3. Stability

Stability translates into safety and should be the priority, meaning the driver may need to sacrifice a perfectly level and comfortable ride. Stability issues include roll control, bounce, dive during braking and sponginess (Fig. 2.3). Tuning out these problems usually requires an increase in pressure.



Bad headlight aim *fig. 2.1*



Rough ride *fig. 2.2*

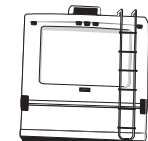

Sway and body roll *fig. 2.3*

GUIDELINES FOR ADDING AIR

1. Start with the vehicle level or slightly above.
2. When in doubt, always add air.
3. If the front of the vehicle dives while braking, increase the pressure in the front air bags, if equipped.
4. If it is ever suspected that the air bags have bottomed out, increase the pressure (Fig. 2.4).
5. Adjust the pressure up and down to find the best ride.
6. If the vehicle rocks and rolls, adjust the air pressure to reduce movement.
7. It may be necessary to maintain different pressures on each side of the vehicle. Loads such as water, fuel, and appliances will cause the vehicle to be heavier on one side (Fig. 2.5). As much as a 50 PSI difference is not uncommon.

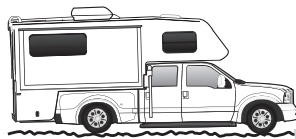

Bottoming out

fig. 2.4

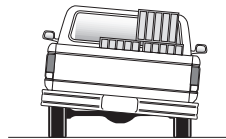

Unlevel

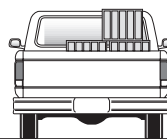

Level

fig. 2.5

Choosing the Right On-Board Air Compressor System

60 DAY NO QUESTIONS ASKED, MONEY-BACK GUARANTEE

TWO-YEAR COMPRESSOR SYSTEM WARRANTY

Add an on-board air compressor system to inflate and deflate your air springs automatically or with the touch of a button — from inside or outside of the vehicle.

- For convenient, on-the-go control of your air springs, add an Air Lift on-board air compressor system.
- Air Lift on-board air compressor systems eliminate the search for gas stations that have a working compressor, saving you time, energy and money.
- All systems include a compressor, controller and all parts needed for easy installation.

1. Choose single or dual path inflation (see illustrations at right)

2. Choose wireless, analog control or automatic

- **Wireless:** Control your air springs from inside or outside the vehicle. Easiest installation — no wires to the cab.
- **Analog:** In-cab control of your air springs. Economically priced.
- **Automatic:** Self-leveling system, keeps the vehicle level no matter what.

3. Choose heavy or standard duty compressor

- **Standard duty:** A standard duty compressor will work well for most customers who use their system on an intermittent basis.
- **Heavy duty:** For daily use, consider the heavy-duty compressor — it inflates faster and more quietly than the standard compressor.

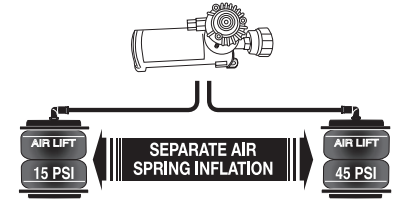

Dual path systems Air springs are controlled separately to allow for different air pressure from side-to-side. Perfect for uneven or top-heavy loads.

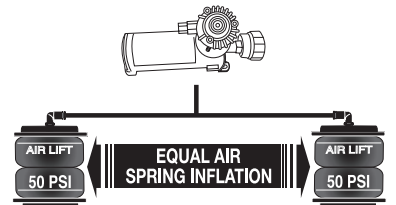

Single path systems Two springs will inflate at the same time. Good for loads that are evenly distributed from left-to-right or front-to-back.

Visit www.airliftcompany.com for more detailed info on compressor systems.

	WIRELESS	ANALOG	AUTOMATIC
SINGLE PATH	<p>WirelessAIR™ <i>OUR PREMIUM SYSTEM!</i></p> <ul style="list-style-type: none"> • Easy installation • Includes heavy-duty compressor <p>P/N 72000</p>	<p>LoadCONTROLLER™ <i>Dual</i></p> <p>Compact, economically priced control.</p> <p>DEFLATE LEFT INFLATE BOTH DEFLATE RIGHT</p> <p>P/N Standard Duty Compressor 25850; P/N Heavy Duty Compressor 25854</p>	<p>SmartAIR™ II</p> <ul style="list-style-type: none"> • Easy installation • Automatic self-leveling system • No in-cab controls required <p>Single Path P/N 25490, Dual Path P/N 25491</p>
	<p>WirelessONE™</p> <ul style="list-style-type: none"> • Easy installation • Includes standard-duty compressor <p>P/N 25870</p>	<p>LoadCONTROLLER™ <i>Single</i></p> <p>Compact, economically priced control.</p> <p>DEFLATE BOTH INFLATE BOTH</p> <p>P/N Standard Duty Compressor 25852; P/N Heavy Duty Compressor 25856</p>	

Limited Warranty and Return Policy

WHAT THIS WARRANTY COVERS

Air Lift Company provides a warranty to the original purchaser of its Load Support Products, for the periods of time listed below, by product line, from the date of original purchase, that the products will be free from defects in workmanship and materials when used on cars and trucks as specified by Air Lift Company and under normal operating conditions, subject to the requirements and exclusions set forth below.

WHAT THIS WARRANTY DOES NOT COVER

The warranty does not apply to products that have been improperly applied, improperly installed, or which have not been maintained in accordance with installation instructions furnished with all products. This warranty does not apply and is void if damage or failure is caused by: accident, abuse, misuse (including but not limited to racing or off-road activities or commercial use), abnormal use, faulty installation, liquid contact, fire, earthquake or other external cause; operating the product outside Air Lift Company's instructions, specifications or guidelines; or service, alteration, maintenance or repairs performed by anyone other than Air Lift Company to the product from its purchased condition. This warranty also does not apply to: consumable parts, such as batteries; cosmetic damage, including but not limited to scratches or dents; defects caused by normal wear and tear or otherwise due to the normal aging of the product, or if any serial or identification number has been removed or defaced from the product. Air Lift Company reserves the right to change the design of any product without assuming any obligation to modify any product previously manufactured.

LIMITATION OF LIABILITY

To the extent permitted by law, this warranty and the remedies set forth herein are exclusive and in lieu of all other warranties, remedies and conditions, whether oral, written, statutory, express or implied. AIR LIFT COMPANY DISCLAIMS ALL STATUTORY AND IMPLIED WARRANTIES, INCLUDING WITHOUT LIMITATION, WARRANTIES OF MERCHANTABILITY AND FITNESS FOR A PARTICULAR PURPOSE AND WARRANTIES AGAINST HIDDEN OR LATENT DEFECTS TO THE EXTENT PERMITTED BY LAW. To the extent such warranties cannot be disclaimed, such implied warranties shall apply only for the warranty period specified above. Please note that some states do not allow limitation on how long an implied warranty (or condition) lasts. So the above limitation may not apply to you.

Except as provided in this warranty and to the extent permitted by law, Air Lift Company shall not be liable for any direct, special, incidental or consequential damages resulting from any breach of warranty or condition, or arising in connection with the sale, use or repair of air lift products, or under any other legal theory, including but not limited to loss of use, loss of revenue, loss of actual or anticipated profits, loss of the use of money, loss of business, loss of opportunity, loss of goodwill, and loss of reputation. Air Lift Company's maximum liability shall not in any case exceed the purchase price paid by you for the Air Lift product. Please note that some states do not allow the exclusion or limitation of incidental or consequential damages, so the above limitation or exclusion may not apply to you.

HOW TO GET SERVICE

If a defect in workmanship or materials causes your Air Lift product to become inoperable within the warranty period, before returning any defective product, call Air Lift Company at (800) 248-0892 in the U.S. and Canada (elsewhere, (517) 322-2144) to obtain a Returned Materials Authorization (RMA) number. The consumer shall be responsible for removing (labor charges) the defective product from the vehicle and returning it, shipping costs prepaid, to Air Lift Company for verification. Returns to Air Lift Company must be postage prepaid and sent to: Air Lift Company • 2727 Snow Road • Lansing, MI • 48917. You must prove to the satisfaction of Air Lift Company the date of original purchase of your Air Lift product. You must also enclose the RMA number and a return address. A minimum \$10 shipping and handling charge will apply to all warranty claims. You must also pack the product to minimize the risk of it being damaged in transit. If we receive a product in damaged condition as the result of shipping, we will notify you and you must seek a claim with the shipper.

WHAT AIR LIFT COMPANY WILL DO

If you submit a valid claim to Air Lift Company during the warranty period, Air Lift Company will, at its option, repair your Air Lift product or furnish you with a new or rebuilt product. Air Lift Company will not reimburse you for repairs or replacement parts provided by other parties. Your repaired or replacement Air Lift product will be returned to you (subject to payment of the required warranty claim shipping and handling charge) and it will be covered under the warranty for the balance of the warranty period, if any. When a product or part is replaced, any replacement item becomes your property and the replaced item becomes property of Air Lift Company. You are responsible for installation/reinstallation (labor charges) of the product.

HOW THE LAW RELATES TO THIS WARRANTY

This warranty gives you specific legal rights and you may also have other rights which vary from state to state. By this warranty, Air Lift Company does not limit or exclude your rights except as allowed by law. To fully understand your rights, you should consult the laws of your state.

SPECIFIC LOAD SUPPORT WARRANTY PERIODS BY PRODUCT LINE

LoadLifter 5000™ Ultimate.....	Lifetime Limited	WirelessAIR™.....	2 Year Limited
LoadLifter 5000™.....	Lifetime Limited	WirelessONE™.....	2 Year Limited
RideControl™.....	Lifetime Limited	LoadController™ Single and Dual.....	2 Year Limited
Air Lift 1000™.....	Lifetime Limited	LoadController™ I and II.....	2 Year Limited
AirCell™.....	Lifetime Limited	SmartAir™ II.....	2 Year Limited
SlamAir™.....	Lifetime Limited	Other Accessories.....	2 Year Limited

Replacement Information

If you need replacement parts, contact the local dealer or call Air Lift customer service at (800) 248-0892. Most parts are immediately available and can be shipped the same day.

Contact Air Lift Company customer service at (800) 248-0892, first if:

- Parts are missing from the kit.
- Need technical assistance on installation or operation.
- Broken or defective parts in the kit.
- Wrong parts in the kit.
- Have a warranty claim or question.

Contact the retailer where the kit was purchased:

- If it is necessary to return or exchange the kit for any reason.
- If there is a problem with shipping if shipped from the retailer.
- If there is a problem with the price.

Contact Information

If you have any questions, comments or need technical assistance, contact our customer service department by calling (800) 248-0892. For calls from outside the USA or Canada, our local number is (517) 322-2144.

For inquiries by mail, our address is PO Box 80167, Lansing, MI 48908-0167. Our shipping address for returns is 2727 Snow Road, Lansing, MI 48917.

You may also contact us anytime by e-mail at sales@airliftcompany.com or on the web at www.airliftcompany.com.

Need Help?

Contact our customer service department by calling (800) 248-0892. For calls from outside the USA or Canada, our local number is (517) 322-2144.

**Register your warranty online at
www.airliftcompany.com/warranty**



Thank you for purchasing Air Lift products — the professional installer's choice!

Air Lift Company • 2727 Snow Road • Lansing, MI 48917 or PO Box 80167 • Lansing, MI 48908-0167
Toll Free (800) 248-0892 • Local (517) 322-2144 • Fax (517) 322-0240 • www.airliftcompany.com

Printed in
the USA