

RideCONTROL™
by AIR LIFT®

Kit 59570
Ford F-150

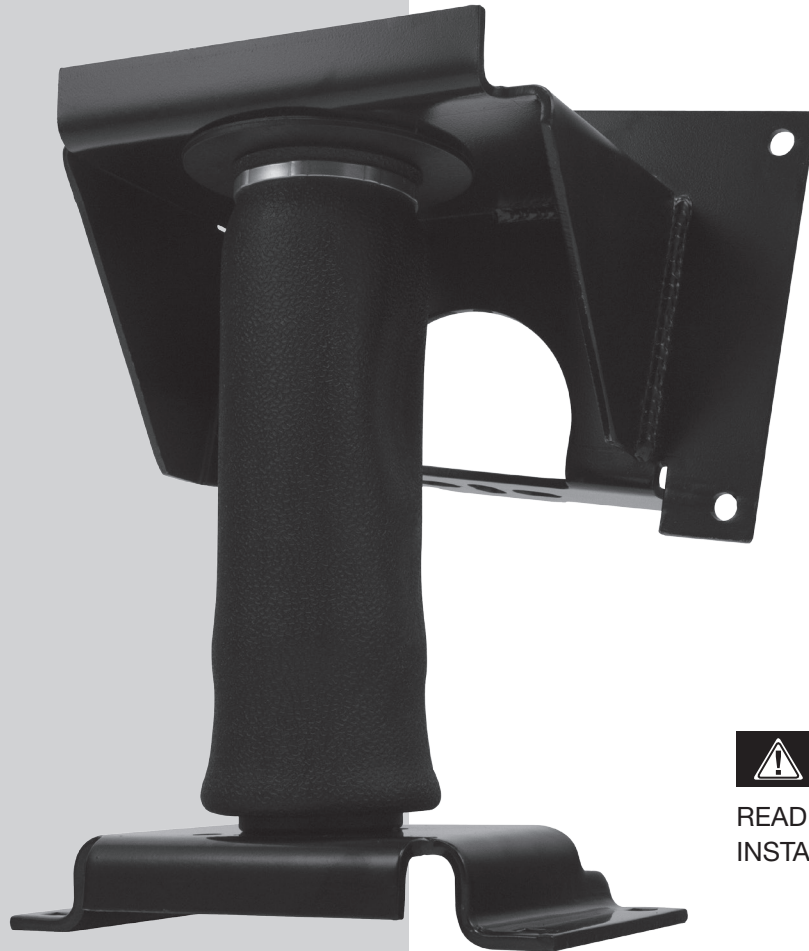

⚠ CAUTION

READ PAGE 9 BEFORE
INSTALLATION



INSTALLATION GUIDE

For maximum effectiveness and safety,
please read these instructions completely
before proceeding with installation.

*Failure to read these instructions can result in an
incorrect installation.*



TABLE OF CONTENTS



Introduction	2
Important Safety Notice	2
Notation Explanation	2
Installation Diagram	3
Hardware List	4
Tools List	4
Installing the RideControl System	5
Installing the Upper Brackets	5
Assembling the Air Spring Assembly	8
Installing the Air Lines	9
Aligning and Finishing the Installation	11
Checking for Leaks	13
Fixing Leaks	13
Before Operating	14
Minimum and Maximum Pressure	15
Maintenance Guidelines	15
Troubleshooting Guide	15
Frequently Asked Questions	16
Tuning the Air Pressure	16
Guidelines for Adding Air	17
Choosing the Right On-Board Air Compressor System	18
Warranty and Return Policy	19
Replacement Information	20
Contact Information	20



Introduction

The purpose of this publication is to assist with the installation and maintenance RideControl air spring kit. The air springs used in RideControl kits are designed and manufactured like a tire. The air springs have layers of rubber and cords that control the bag's growth and funnel it into one direction. The bags do not require a coil spring for control. RideControl kits utilize a sleeve style air bag that provides up to 2,000 pounds of load-leveling support. Each sleeve is rated at a maximum of 100 PSI

It is important to read and understand the entire installation guide before beginning installation or performing any maintenance, service or repair. The information here includes a hardware list, tool list, step-by-step installation information, maintenance tips and safety information.

Air Lift Company reserves the right to make changes and improvements to its products and publications at any time. Contact Air Lift Company at (800) 248-0892 or visit us online at www.airliftcompany.com for the latest version of this manual.

IMPORTANT SAFETY NOTICE

The installation of this kit does not alter the Gross Vehicle Weight Rating (GVWR) or payload of the vehicle. Check your vehicle's owner's manual and do not exceed the maximum load listed for your vehicle.

Gross Vehicle Weight Rating: The maximum allowable weight of the fully loaded vehicle (including passengers and cargo). This number — along with other weight limits, as well as tire, rim size and inflation pressure data — is shown on the vehicle's Safety Compliance Certification Label.

Payload: The combined, maximum allowable weight of cargo and passengers that the truck is designed to carry. Payload is GVWR minus the Base Curb Weight.

NOTATION EXPLANATION

Hazard notations appear in various locations in this publication. Information which is highlighted by one of these notations must be observed to help minimize risk of personal injury or possible improper installation which may render the vehicle unsafe. Notes are used to help emphasize areas of procedural importance and provide helpful suggestions. The following definitions explain the use of these notations as they appear throughout this guide.

DANGER

INDICATES IMMEDIATE HAZARDS WHICH WILL RESULT IN SEVERE PERSONAL INJURY OR DEATH.

WARNING

INDICATES HAZARDS OR UNSAFE PRACTICES WHICH COULD RESULT IN SEVERE PERSONAL INJURY OR DEATH.

CAUTION

INDICATES HAZARDS OR UNSAFE PRACTICES WHICH COULD RESULT IN DAMAGE TO THE MACHINE OR MINOR PERSONAL INJURY.

NOTE

Indicates a procedure, practice or hint which is important to highlight.

Installation Diagram

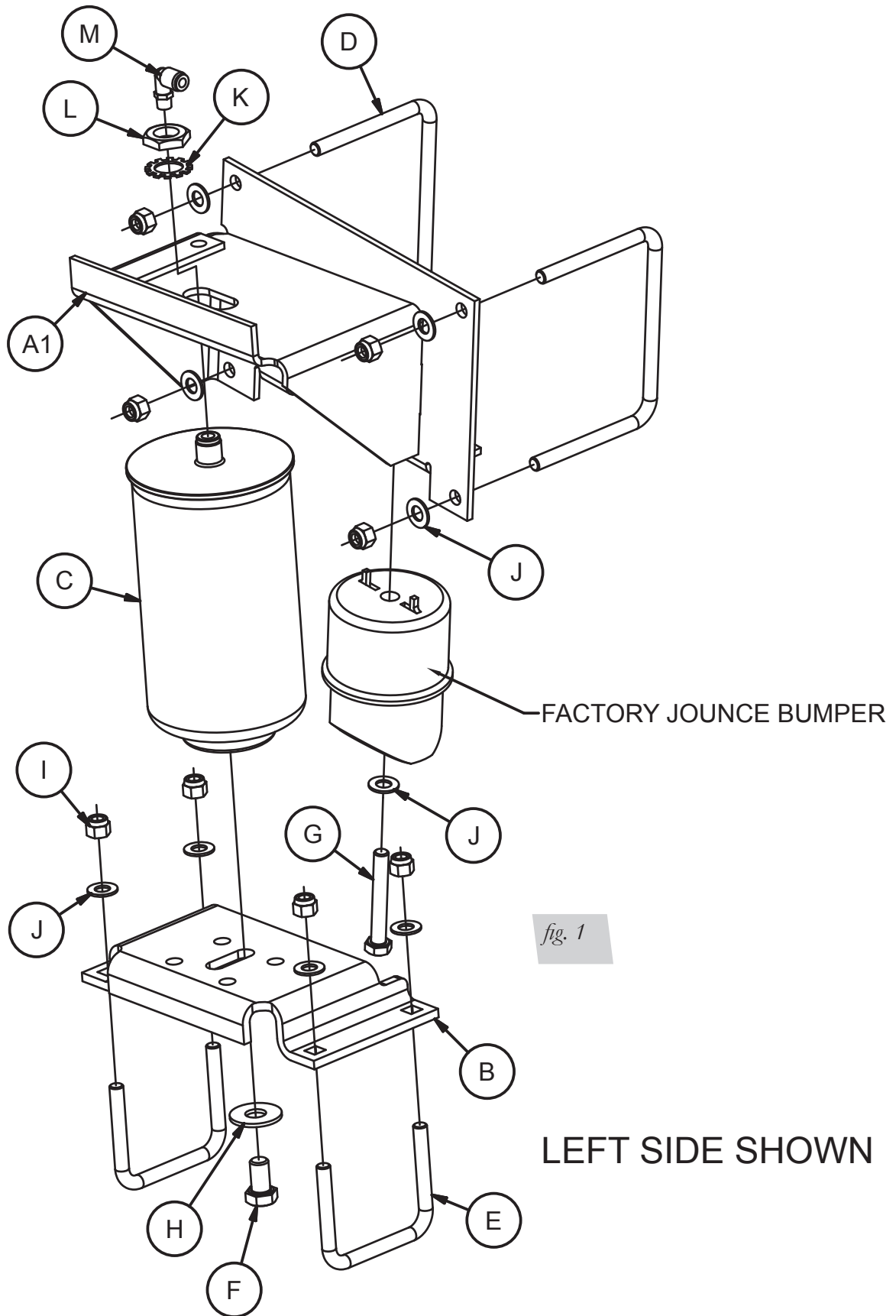

HARDWARE LIST

Item	Part #	Description.....Qty	Item	Part #	Description.....Qty
A1	07170	Left-hand upper bracket.....1	K	18450	3/4" serrated lock washer.....2
A2	07474	Right-hand frame bracket1	L	18454	3/4"-16 nyloc jam nut2
B	03008	Lower bracket2	M	21837	90° swivel fitting2
C	58571	Air spring.....2	AA	20086	Air line1
D	10787	Frame U-bolts4	BB	10466	Tie strap6
E	10975	Lower bracket U-bolts4	CC	21230	Valve cap2
F	17124	1/2"-3 X 7/8" hex head cap screw2	DD	18501	5/16" flat washer2
G	17499	M10-1.50 X 70 tap bolt2	EE	21234	Rubber washer.....2
H	18414	1/2" flat washer2	FF	18401	Star washer.....2
I	18435	3/8"-16 Nyloc nut.....16	GG	21233	5/16" hex nut.....4
J	18444	3/8" Flat washer18			



Missing or damaged parts? Call Air Lift customer service at (800) 248-0892 for a replacement part.

TOOLS LIST

Description..... Qty	Description..... Qty
Hoist or floor jacks..... 1	5/16" drill bit (very sharp)..... 1
Safety stands..... 2	Heavy duty drill..... 1
Safety glasses 1	Bench or hand grinder..... 1
Torque wrench..... 1	Black spray paint 1
Standard open-end combo wrenches..... 1	Hose cutter, razor blade, or sharp knife 1
Medium size crescent wrench 1	Air compressor or compressed air source..... 1
Ratchet 1	Spray bottle with dish soap/water solution 1
Metric and standard sockets..... 1	

Installing the RideControl System

INSTALLING THE UPPER BRACKETS

1. Jack the vehicle up and support the axle with safety stands. Remove the rear wheels (fig. 2).



fig. 2

2. Unbolt and remove the jounce bumpers (these will be reinstalled later) (fig. 3).

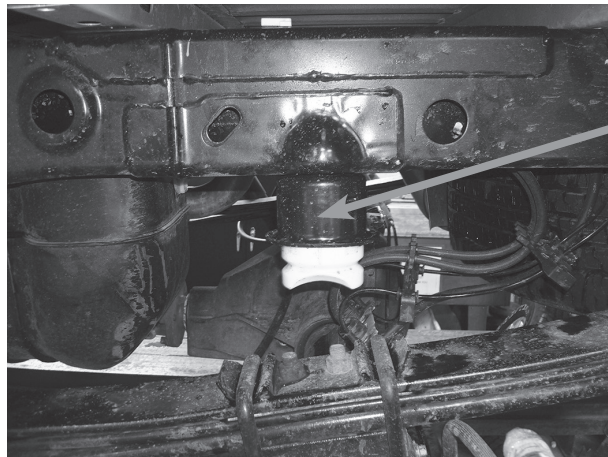

Remove the jounce bumpers. These will be reinstalled later.

fig. 3

3. Set the frame U-bolts (D) around the frame from the inside-out on both sides of the vehicle—ahead of and behind where the jounce bumper is mounted. Figure 6 shows both U-bolts installed between the brake lines and wiring. Repeat U-bolt installation for the right side (passenger side).

CAUTION

DO NOT PINCH THE BRAKE LINES AND WIRING ON THE INSIDE OF THE LEFT (DRIVER SIDE FRAME). U-BOLTS MUST BE BETWEEN THESE COMPONENTS AND THE FRAME (FIGS. 4, 5, AND 6).

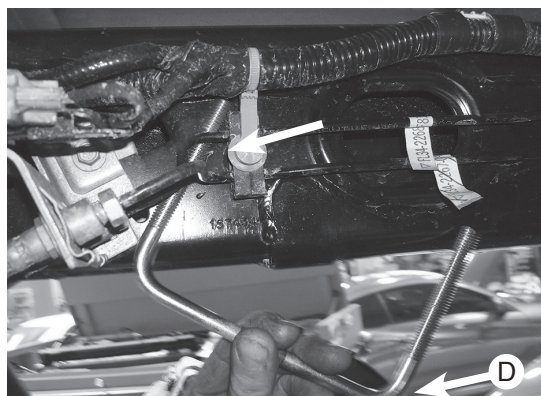
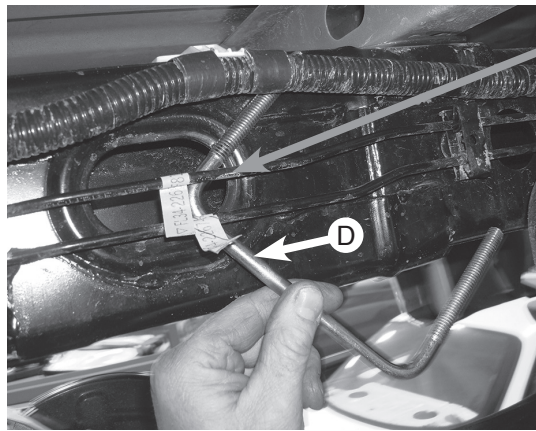

Figure 4 shows U-bolt (D) being installed on the inside of the left (driver-side) frame section on the back side of the jounce bumper mounting location.

fig. 4

Figure 5 shows U-bolt (D) being installed on the inside of the left (driver-side) frame section on the front side of where the jounce bumper is mounted.

fig. 5



CAUTION: DO NOT PINCH THE BRAKE LINES AND WIRING ON THE INSIDE OF THE LEFT (DRIVER SIDE) FRAME. U-BOLTS MUST BE BETWEEN THESE COMPONENTS AND THE FRAME.

fig. 6

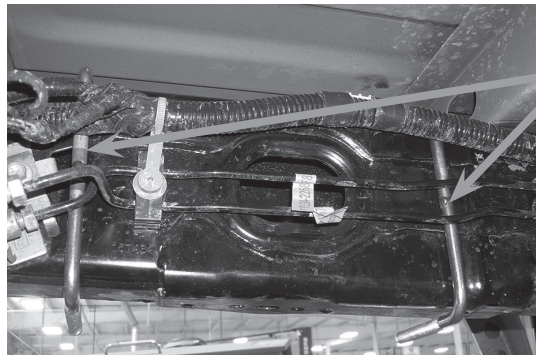

Figure 6 shows the U-bolts in the proper location, under the brake lines and wiring on the inside of the left side frame (driver-side).

4. With the U-bolts into position, set the left (A1) and right (A2) upper bracket against the frame while aligning the U-bolts (fig. 7) through the mounting holes in the bracket (fig. 8).



fig. 7

Figure 7 shows the left (driver-side) outside frame with the U-bolts in position.



fig. 8

Figure 8 shows the left (driver-side) outside frame with the upper bracket over the U-bolts and in position.

5. Cap the U-bolts with four 3/8" flat washers (J) and 4 x 3/8" nyloc nuts (I) (fig. 1). Leave loose at this time.
6. In order to make sufficient clearance for the flex member (the rubber part) on the air spring, it will be necessary to trim the edge of the bracket off on the outside flange of the jounce bumper cup (steel portion). Do this by grinding the flange flush with the rest of the cup (figs. 9 and 10). Spray black paint on the bare metal surface once complete. Repeat for both sides.

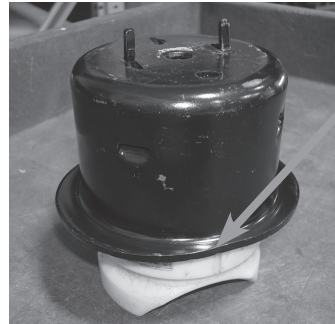

The outside edge of the jounce bumper cup will need to be trimmed here.

fig. 9



The outside edge of the jounce bumper cup showed trimmed. Spray bare surface with black paint.

fig. 10

7. Insert the M-10 tap bolt (G) through a flat washer (J) and then through the jounce bumper (fig. 1). Using the center hole in the bottom flange of the upper bracket, install this assembly back onto the bottom frame flange in the location from which it was removed, making sure the edge that was ground off faces the outside of the vehicle (fig. 11). Tighten the bolt so that the bracket just touches the frame at this time. Do not tighten or torque yet. Repeat for the opposite side.



fig. 11

CAUTION

MAKE ONE LAST CHECK THAT THE U-BOLTS ON THE INSIDE OF THE LEFT FRAME (DRIVER SIDE) ARE NOT PINCHING THE BRAKE LINES OR THE WIRING. ADJUST IF NECESSARY AT THIS POINT.

8. With the upper bracket flush to the bottom frame flange from the last step, torque the frame U-bolts evenly to 10 ft-lbs. Once this is done and the bracket is flush against the frame, torque the jounce bumper bolt to 30 ft-lbs. Repeat for the other side.

ASSEMBLING THE AIR SPRING ASSEMBLY

1. Install the fitting (M) onto the top port of the air spring (C) (fig. 12) finger-tight plus one-and-a-half turns. Repeat for both air springs.

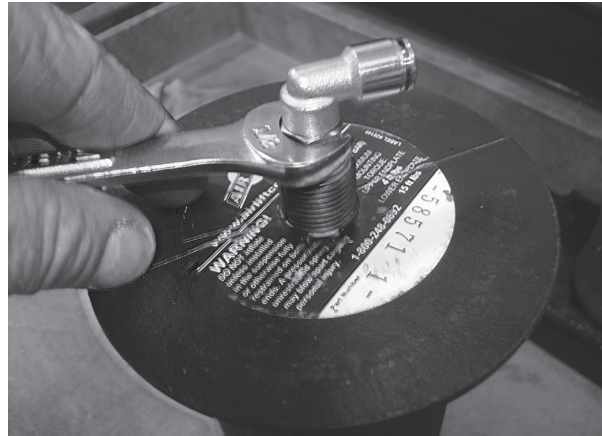
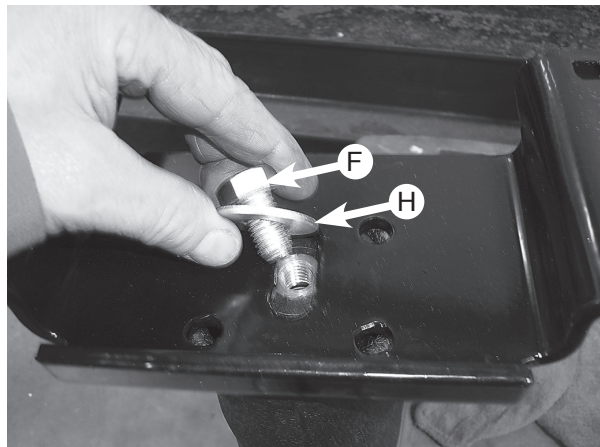

fig. 12

2. Install the air springs (C) to the lower brackets (B) using the 1/2" bolt (F) and flat washer (H) (figs. 1 and 13). Leave loose at this time.



Loosely attach the spring (C) to the lower bracket (B) with the 1/2" bolt (F) and flat washer (H).

fig. 13

3. Set the assemblies onto the leaf spring making sure the upper fitting and thread post on the air spring goes through the slot in the upper bracket. The flange on the lower bracket points to the outside (tire-side) of the vehicle (fig. 14).

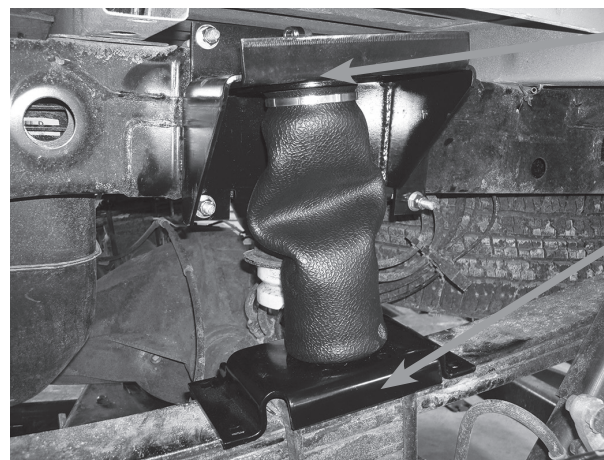

Make sure the fitting and thread post go through the slot in the upper bracket.

Make sure the flange on the lower bracket points to the outside (tire-side) of the vehicle.

fig. 14

4. Set the lower bracket U-bolts (E) under the leaf springs and through the holes in the lower bracket (fig. 15) and cap with four 3/8" flat washers (J) and 3/8" nyloc nuts (I). Torque to finger-tight only at this time.

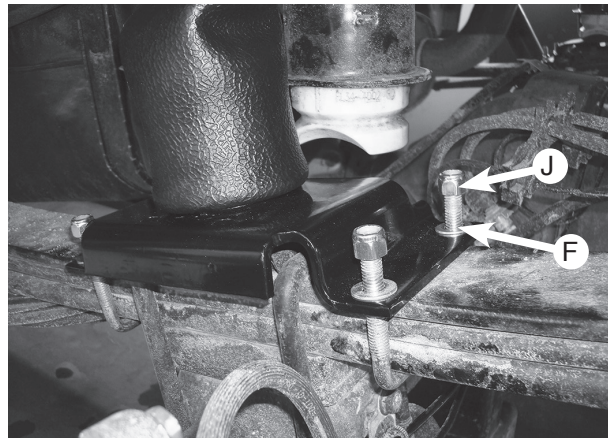

fig. 15

Install U-bolts under leaf springs and through the holes in the lower bracket and cap with flat washers (J) and nyloc nuts (I). Torque to finger-tight only at this time.

5. Install the upper air spring hardware by setting the 3/4" serrated lock washer (K) over the fitting and thread post (fig. 16). Set the 3/4" nyloc jam nut (L) over the fitting (with the flat side down) and thread onto the post. Torque to finger-tight only at this time.

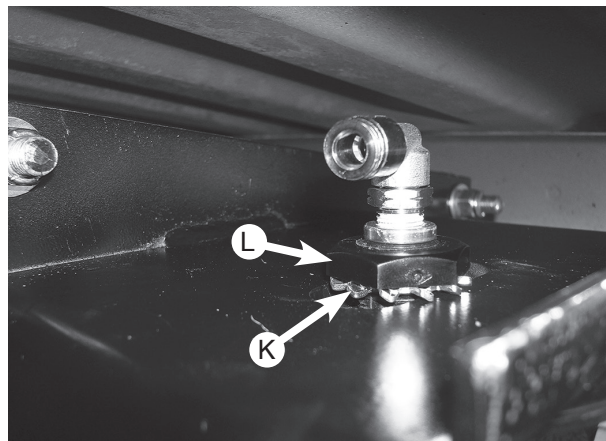

fig. 16

Set 3/4" serrated flat washer (K) over fitting and thread post on the air spring. Thread the nylon jam nut (L) onto the thread post. Torque to finger-tight only.

INSTALLING THE AIR LINES

1. Ford prefers not to have any non-aluminum component be attached to the body of this truck. It will be necessary to find a steel mounting location for the inflation valve, such as:
 - a. the license plate recess in bumper,
 - b. under the bumper,
 - c. bumper mounting brackets.

NOTE

What ever the chosen location is, make sure there is enough clearance around the inflation valves for an air chuck.

2. Drill two 5/16" holes to install the inflation valves.
3. Cut the air line assembly in two equal lengths.

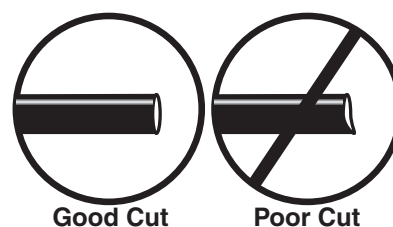
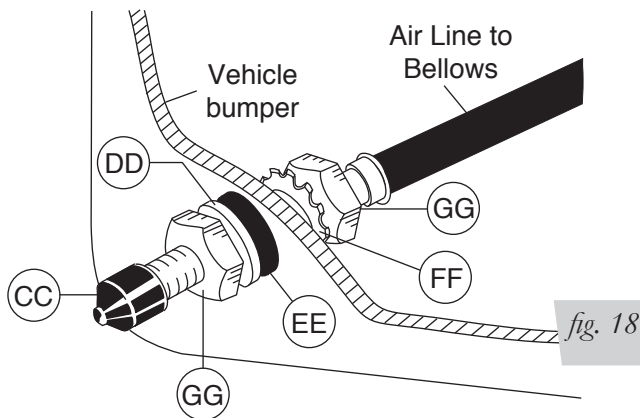

fig. 17

CAUTION

WHEN CUTTING OR TRIMMING THE AIR LINE, USE A HOSE CUTTER, A RAZOR BLADE, OR A SHARP KNIFE. A CLEAN, SQUARE CUT WILL PREVENT LEAKS. DO NOT USE WIRE CUTTERS OR SCISSORS TO CUT THE AIR LINE. THESE TOOLS MAY FLATTEN OR CRIMP THE AIR LINE CAUSING IT TO LEAK AROUND THE O-RING SEAL INSIDE THE ELBOW FITTING (FIG. 17).



4. Place a 5/16" nut (GG) and a star washer (FF) on the air valve. Leave enough of the inflation valve in front of the nut to extend through the hole and have room for the rubber washer (EE), flat washer (DD), and 5/16" nut (GG) and cap (CC). There should be enough valve exposed after installation - approximately 1/2" - to easily apply a pressure gauge or an air chuck (fig. 18).
5. Push the inflation valve through the hole and use the rubber washer (EE), flat washer (DD), and another 5/16" nut (GG). Tighten the nuts to secure the assembly in place (fig. 18).
6. Route the air line along the frame to the air fitting on the air spring (fig. 19). Keep AT LEAST 6" of clearance between the air line and heat sources, such as the exhaust pipes, muffler, or catalytic converter. Avoid sharp bends and edges. Use the plastic tie straps to secure the air line to fixed, non-moving points along the chassis. Be sure that the tie straps are tight, but do not pinch the air line. Leave at least 2" of slack to allow for any movement that might pull on the air line.

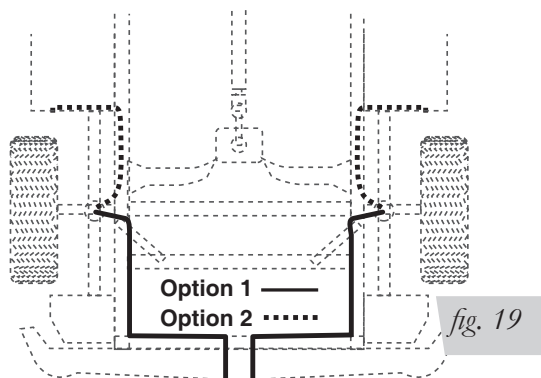

7. Cut off the air line, leaving approximately 12" of extra air line. A clean square cut will ensure that the line will not leak. Insert the air line into the air fitting. This is a push-to-connect fitting. Simply push the air line into the 90° swivel fitting until it bottoms out (9/16" of air line should be in the fitting).

ALIGNING AND FINISHING THE INSTALLATION

1. With the mounting hardware and hose assembly in place, inflate the air spring to 5 PSI (only) at this time.
2. Adjust the spring so that it is perpendicular to both top and bottom brackets by using the slot in the top and bottom mounts. Pinch the flex member at the bottom around the piston (figs. 20 and 21). There should be a symmetrical cushion of air around the flex member and piston.

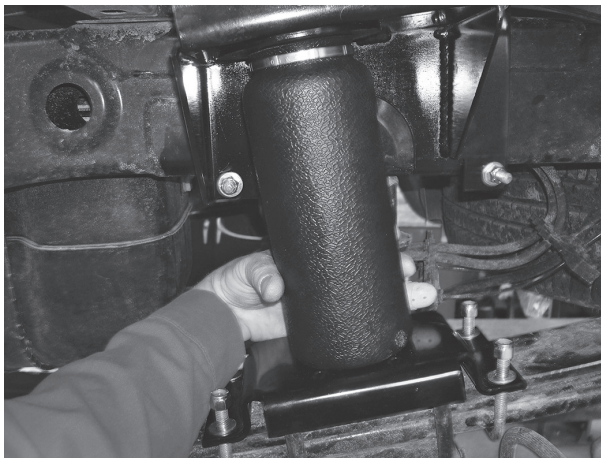

fig. 20

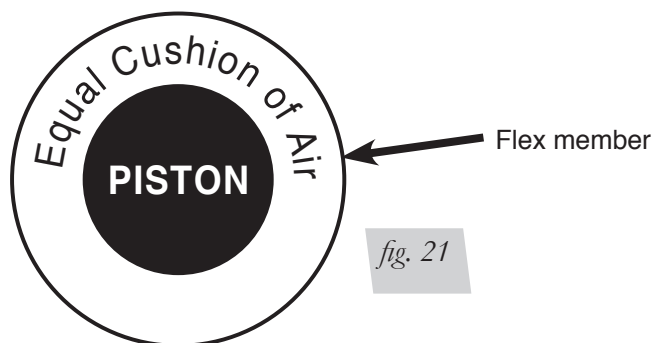
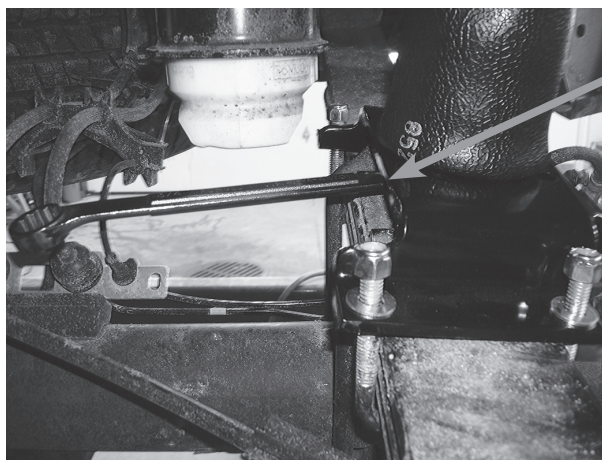

fig. 21

3. You will need to adjust and tighten the bottom of the air spring first. In order to do this, mark the location of the bottom piston in reference to the lower bracket. Deflate the air pressure from the air spring and raise the inside of the lower bracket up enough to slip a 3/4" open end wrench onto the 1/2" bolt, which is attaching the spring to the lower mount (fig. 22). Tighten the bolt no more than 15 ft-lbs. Repeat for the opposite side.



Raise the inside of the lower bracket up enough to slip a 3/4" wrench over the 1/2" bolt and torque to no more than 15 ft-lbs.

fig. 22

4. Once the lower is set, inflate the air springs back to 5 PSI and, if necessary, readjust the upper spring forward or back in the slot. Using a medium crescent wrench or an open end wrench, tighten the nylon jam nut to no more than 4 ft-lbs. (just snug) (fig. 23). Repeat for the other side.

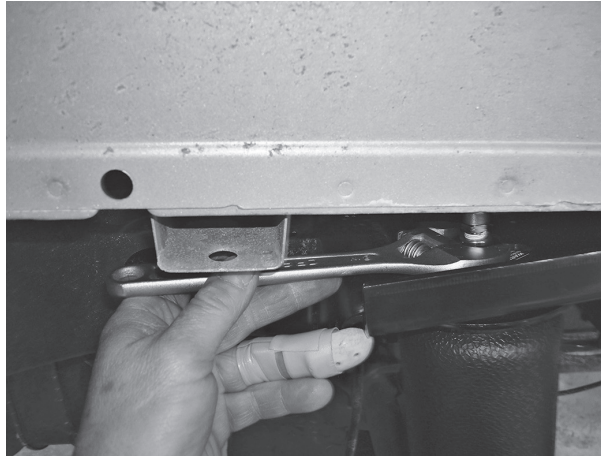

Adjust air spring and torque to no more than 4 ft-lbs. using a medium size crescent wrench or open end wrench.

fig. 23

5. Once the air spring has been properly aligned, torque the lower mounting hardware on the lower bracket U-bolts to 15 ft-lbs. on both sides.
6. Figures 24 and 25 show the left- and right-hand assemblies installed on the vehicle.

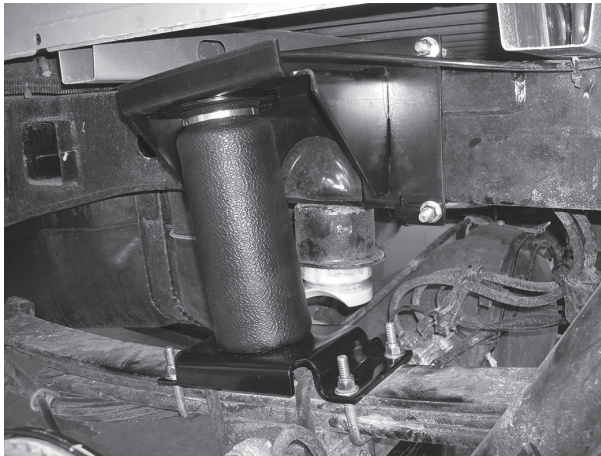

Back, side view of left side (driver-side) installation shown.

fig. 24

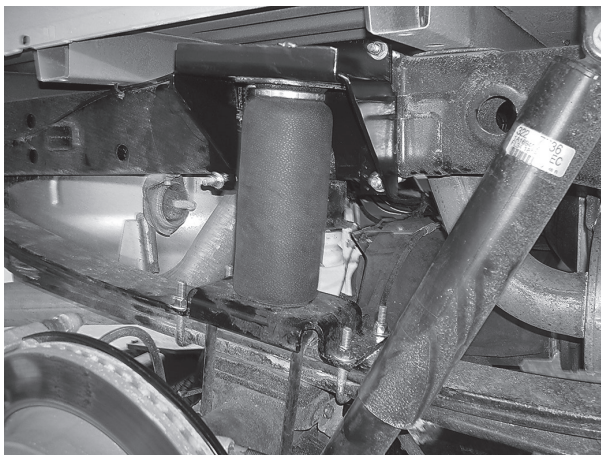

Forward, side view of right-side (passenger-side) installation shown.

fig. 25

7. Install the tires back onto the vehicle and torque to the manufactures torque specifications.

CHECKING FOR LEAKS

1. Inflate the air spring to 30 PSI.
2. Spray all connections and the inflation valves with a solution of 1/5 liquid dish soap and 4/5 water. Spot leaks easily by looking for bubbles in the soapy water.
3. After the test, deflate the springs to the minimum pressure required to restore the system to normal ride height. Do not deflate to lower than 5 PSI.
4. Check the air pressure again after 24 hours. A 2 - 4 PSI loss after initial installation is normal. Retest for leaks if the loss is more than 5 lbs.

FIXING LEAKS

1. If there is a problem with the swivel fitting:
 - a. Check the air line connection by deflating the spring and removing the line by pulling the collar against the fitting and pulling firmly on the air line. Trim 1" off the end of the air line. Be sure the cut is clean and square (see fig. 17). Reinsert the air line into the push-to-connect fitting.
 - b. Check the threaded connection by tightening the swivel fitting another 1/2 turn. If it still leaks, deflate the air spring, remove the fitting, and re-coat the threads with thread sealant. Reinstall by hand tightening as much as possible and then use a wrench for an additional two turns.
2. If there is a problem with the inflation valve:
 - a. Check the valve core by tightening it with a valve core tool.
 - b. Check the air line by removing the air line from the barbed type fitting. Cut the air line off a few inches in front of the fitting and use a pair of pliers or vice grips to pull/twist the air line off of the fitting.



CAUTION

DO NOT CUT OFF THE AIR LINE COMPLETELY AS THIS WILL USUALLY NICK THE BARB AND RENDER THE FITTING USELESS.

3. If the preceding steps have not resolved the problem, call Air Lift customer service at (800) 248-0892.

Before Operating

INSTALLATION CHECKLIST (To be completed by installer)

- Clearance test — Inflate the air springs to 60 PSI and ensure there is at least 1/2" clearance around each bellow, away from anything that might rub against them. Be sure to check the tire, brake drum, frame, shock absorbers and brake cables.
- Leak test before road test — Inflate the air springs to 60 PSI, check all connections for leaks with a soapy water solution. See the *Checking for Leaks* section for tips on how to spot leaks. All leaks must be eliminated before the vehicle is road tested.
- Heat test — Be sure there is sufficient clearance from any heat sources — at least 6" for air springs and air lines. If a heat shield was included in the kit, install it. If there is no heat shield, but one is required, call (800) 248-0892.
- Fastener test — Recheck all bolts for proper torque. Re-torque after 100 miles.
- Road test — The vehicle should be road tested after the preceding tests. Inflate the air springs to 25 PSI (50 PSI if the vehicle is loaded). Drive the vehicle 10 miles and recheck for clearance, loose fasteners and air leaks.
- Operating instructions — If professionally installed, the installer should review the *Product Use, Maintenance and Servicing* section with the owner. Be sure to provide the owner with all of the paperwork which came with the kit.

Technician's Signature _____

Date _____

POST-INSTALLATION CHECKLIST

- Overnight leak down test — Recheck air pressure after the vehicle has been used for 24 hours. If the pressure has dropped more than 5 PSI, then there is a leak that must be fixed. Either fix the leak yourself or return to the installer for service.
- Air pressure requirements — Regardless of load, the air pressure should always be adjusted to maintain ride height at all times.
- Thirty day or 500 mile test — Recheck the air spring system after 30 days or 500 miles, whichever comes first. If any part shows signs of rubbing or abrasion, the source should be identified and moved, if possible. If it is not possible to relocate the cause of the abrasion, the air spring may need to be remounted. If professionally installed, the installer should be consulted. Check all fasteners for tightness.

Product Use, Maintenance and Servicing

Minimum Recommended Pressure	Maximum Air Pressure
5 PSI	100 PSI

MAINTENANCE GUIDELINES

NOTE

By following the steps below, vehicle owners will obtain the longest life and best results from their air springs.

1. Check the air pressure weekly.
2. Always maintain normal ride height. Never inflate beyond 100 PSI.
3. If you develop an air leak in the system, use a soapy water solution (1/5 liquid dish soap and 4/5 water) to check all air line connections and the inflation valve core before deflating and removing the air spring.

CAUTION

FOR YOUR SAFETY AND TO PREVENT POSSIBLE DAMAGE TO YOUR VEHICLE, DO NOT EXCEED MAXIMUM GROSS VEHICLE WEIGHT RATING (GVWR), AS INDICATED BY THE VEHICLE MANUFACTURER. ALTHOUGH YOUR AIR SPRINGS ARE RATED AT A MAXIMUM INFLATION PRESSURE OF 100 PSI, THE AIR PRESSURE ACTUALLY NEEDED IS DEPENDANT ON YOUR LOAD AND GVWR.

4. Loaded vehicles require at least 25 PSI or more. A “loaded vehicle” refers to a vehicle with a heavy bed load, a trailer, or both. As discussed above, never exceed GVWR, regardless of air spring, air pressure, or other load assist. The springs in this kit will support approximately 40 lbs. of load (combined on both springs) for each 1 PSI of pressure. The required air pressure will vary depending on the state of the original suspension. Operating the vehicle below the minimum air spring pressure will void the Air Lift warranty.
5. When increasing load, always adjust the air pressure to maintain the normal ride height. Increase or decrease pressure from the system as necessary to attain normal ride height for optimal ride and handling. Remember that loads carried behind the axle (including tongue loads) require more leveling force (pressure) than those carried directly over the axle.
6. Always add air to springs in small quantities, checking the pressure frequently.
7. Should it become necessary to raise the vehicle by the frame, make sure the system is at minimum pressure (5 PSI) to reduce the tension on the suspension/brake components. Use of on board leveling systems do not require deflation or disconnection.
8. Periodically check the air spring system fasteners for tightness. Also, check the air springs for any signs of rubbing. Realign if necessary.
9. On occasion, give the air springs a hard spray with a garden hose in order to remove mud, sand, gravel or other abrasive debris.

TROUBLESHOOTING GUIDE

1. Leak test the air line connections, the threaded connection into the air spring, and all fittings in the control system.
2. Inspect the air lines to be sure none are pinched. Tie straps may be too tight. Loosen or replace the strap and replace leaking components.
3. Inspect the air line for holes and cracks. Replace as needed.
4. Look for a kink or fold in the air line. Reroute as needed.

If the preceding steps do not solve the problem, it is possibly caused by a failed air spring — either a factory defect or an operating problem. Please call Air Lift at (800) 248-0892 for assistance.

FREQUENTLY ASKED QUESTIONS

Q. Will installing air springs increase the weight ratings of a vehicle?

No. Adding air springs will not change the weight ratings (GAWR, GCWR and/or GVWR) of a vehicle. Exceeding the GVWR is dangerous and voids the Air Lift warranty.

Q. Is it necessary to keep air in the air springs at all times and how much pressure will they need?

For LoadLifter 5000 Ultimate, the recommended minimum air pressure is 5 PSI, but it can safely be run at zero air pressure.

Q. Is it necessary to add a compressor system to the air springs?

No. Air pressure can be adjusted with any type of compressor as long as it can produce sufficient pressure to service the springs. Even a bicycle tire pump can be used, but it's a lot of work.

Q. How long should air springs last?

If the air springs are properly installed and maintained they can last indefinitely.

Q. Will raising the vehicle on a hoist for service work damage the air springs?

No. The vehicle can be lifted on a hoist for short-term service work such as tire rotation or oil changes. However, if the vehicle will be on the hoist for a prolonged period of time, support the axle with jack stands in order to take the tension off of the air springs.

TUNING THE AIR PRESSURE

Pressure determination comes down to three things — level vehicle, ride comfort, and stability.

1. Level vehicle

If the vehicle's headlights are shining into the trees or the vehicle is leaning to one side, then it is not level (fig. 2.1). Raise the air pressure to correct either of these problems and level the vehicle.

2. Ride comfort

If the vehicle has a rough or harsh ride it may be due to either too much pressure or not enough (fig. 2.2). Try different pressures to determine the best ride comfort.

3. Stability

Stability translates into safety and should be the priority, meaning the driver may need to sacrifice a perfectly level and comfortable ride. Stability issues include roll control, bounce, dive during braking and sponginess (fig. 2.3). Tuning out these problems usually requires an increase in pressure.

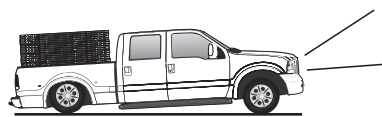

Bad headlight aim

fig. 2.1



Rough ride

fig. 2.2

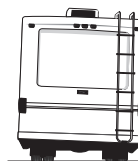

Sway and
body roll

fig. 2.3

GUIDELINES FOR ADDING AIR

1. Start with the vehicle level or slightly above.
2. When in doubt, always add air.
3. If the front of the vehicle dives while braking, increase the pressure in the front air bags, if equipped.
4. If it is ever suspected that the air bags have bottomed out, increase the pressure (fig. 2.4).
5. Adjust the pressure up and down to find the best ride.
6. If the vehicle rocks and rolls, adjust the air pressure to reduce movement.
7. It may be necessary to maintain different pressures on each side of the vehicle. Loads such as water, fuel, and appliances will cause the vehicle to be heavier on one side (fig. 2.5). As much as a 50 PSI difference is not uncommon.



Bottoming out

fig. 2.4

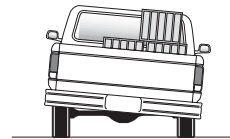

Unlevel

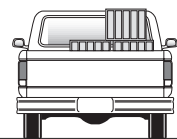

Level

fig. 2.5

Choosing the Right On-Board Air Compressor System

60 DAY NO QUESTIONS ASKED, MONEY-BACK GUARANTEE

TWO YEAR COMPRESSOR SYSTEM WARRANTY

Add an on-board air compressor system to inflate and deflate your air springs with the touch of a button — from inside or outside of the vehicle.

- For convenient, on-the-go control of your air springs, add an Air Lift on-board air compressor system.
- Air Lift on-board air compressor systems eliminate the search for gas stations that have a working compressor, saving you time, energy and money.
- All systems include a compressor, controller and all parts needed for easy installation.

1. Choose single or dual path inflation (see illustrations at right)

2. Choose wireless or analog control

- **Wireless:** Control your air springs from inside or outside the vehicle. Easiest installation - no wires to the cab.
- **Analog:** In-cab control of your air springs. Economically priced.

3. Choose heavy or standard duty compressor

- **Standard duty:** A standard duty compressor will work well for most customers who use their system on an intermittent basis.
- **Heavy duty:** For daily use, consider the heavy duty compressor - it inflates faster and more quietly than the standard compressor.

Visit www.airliftcompany.com for more detailed info on compressor systems.

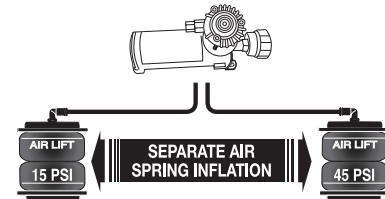

Dual path systems Air springs are controlled separately to allow for different air pressure from side-to-side. Perfect for uneven or top-heavy loads.

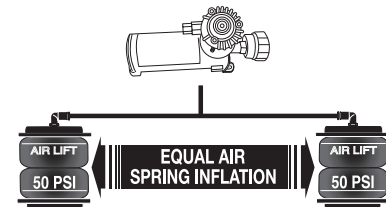

Single path systems Two springs will inflate at the same time. Good for loads that are evenly distributed from left-to-right or front-to-back.

WIRELESS

ANALOG

DUAL PATH

WirelessAIR™

PATENTED!

- Easy installation
- Includes heavy duty compressor



P/N 72000

WirelessONE™

PATENTED!

- Easy installation
- Includes standard duty compressor



P/N 25870

LoadCONTROLLER™

Dual

Compact, economically priced control.

PATENT PENDING!



P/N Standard Duty Compressor 25850; P/N Heavy Duty Compressor 25854

LoadCONTROLLER™

Single

Compact, economically priced control.

PATENT PENDING!



P/N Standard Duty Compressor 25852; P/N Heavy Duty Compressor 25856

Warranty and Returns Policy

Air Lift Company warrants its products, for the time periods listed below, to the original retail purchaser against manufacturing defects when used on catalog-listed applications on cars, vans, light trucks and motorhomes under normal operating conditions for as long as Air Lift manufactures the product. The warranty does not apply to products that have been improperly applied, improperly installed, used in racing or off-road applications, used for commercial purposes, or which have not been maintained in accordance with installation instructions furnished with all products. The consumer will be responsible for removing (labor charges) the defective product from the vehicle and returning it, transportation costs prepaid, to the dealer from which it was purchased or to Air Lift Company for verification.

Air Lift will repair or replace, at its option, defective products or components. A minimum \$10.00 shipping and handling charge will apply to all warranty claims. Before returning any defective product, you must call Air Lift at (800) 248-0892 in the U.S. and Canada (elsewhere, (517) 322-2144) for a Returned Materials Authorization (RMA) number. Returns can be sent to: Air Lift Company • 2727 Snow Road • Lansing, MI • 48917.

Product failures resulting from abnormal use or misuse are excluded from this warranty. The loss of use of the product, loss of time, inconvenience, commercial loss or consequential damages is not covered. The consumer is responsible for installation/reinstallation (labor charges) of the product. Air Lift Company reserves the right to change the design of any product without assuming any obligation to modify any product previously manufactured.

This warranty gives you specific legal rights and you may also have other rights that vary from state-to-state. Some states do not allow limitations on how long an implied warranty lasts or allow the exclusion or limitation of incidental or consequential damages. The above limitation or exclusion may not apply to you. There are no warranties, expressed or implied including any implied warranties of merchantability and fitness, which extend beyond this warranty period. There are no warranties that extend beyond the description on the face hereof. Seller disclaims the implied warranty of merchantability. (Dated proof of purchase required.)

Air Lift 1000™	Lifetime Limited	LoadController/Dual™	2 Year Limited
RideControl™	Lifetime Limited	Load Controller™ (I)	2 Year Limited
LoadLifter 5000™*	Lifetime Limited	Load Controller™ (II)	2 Year Limited
LoadLifter 5000™ Ultimate ...	Lifetime Limited	SmartAir™	2 Year Limited
SlamAir™	Lifetime Limited	WirelessAIR™	2 Year Limited
AirCell™	Lifetime Limited	WirelessONE™	2 Year Limited
Air Lift Performance**	1 Year Limited	Other Accessories	2 Year Limited
LoadController/Single™	2 Year Limited		

**formerly SuperDuty*

***formerly LifeSTYLE & Performance, EasyStreet*

Replacement Information

If you need replacement parts, contact the local dealer or call Air Lift customer service at (800) 248-0892. Most parts are immediately available and can be shipped the same day.

Contact Air Lift Company customer service at (800) 248-0892, first if:

- Parts are missing from the kit.
- Need technical assistance on installation or operation.
- Broken or defective parts in the kit.
- Wrong parts in the kit.
- Have a warranty claim or question.

Contact the retailer where the kit was purchased:

- If it is necessary to return or exchange the kit for any reason.
- If there is a problem with shipping if shipped from the retailer.
- If there is a problem with the price.

Contact Information

If you have any questions, comments or need technical assistance, contact our customer service department by calling (800) 248-0892, Monday through Friday. For calls from outside the USA or Canada, our local number is (517) 322-2144.

For inquiries by mail, our address is PO Box 80167, Lansing, MI 48908-0167. Our shipping address for returns is 2727 Snow Road, Lansing, MI 48917.

You may also contact us anytime by e-mail at sales@airliftcompany.com or on the web at www.airliftcompany.com.

Need Help?

Contact our customer service department by calling (800) 248-0892, Monday through Friday. For calls from outside the USA or Canada, our local number is (517) 322-2144.

**Register your warranty online at
www.airliftcompany.com/warranty**



Thank you for purchasing Air Lift products — the professional installer's choice!

Air Lift Company • 2727 Snow Road • Lansing, MI 48917 or PO Box 80167 • Lansing, MI 48908-0167
Toll Free (800) 248-0892 • Local (517) 322-2144 • Fax (517) 322-0240 • www.airliftcompany.com

Printed in
the USA