



Installation Instructions

For Part Numbers:

400-260	720-479 Airaid Oiled Media Filter
401-260	721-479 SynthaMax Dry Media Filter - Red
402-260	722-479 SynthaMax Dry Media Filter - Black
403-260	723-479 SynthaMax Dry Media Filter - Blue

2013-15 Ford Explorer Sport
3.5L V6 Eco-Boost

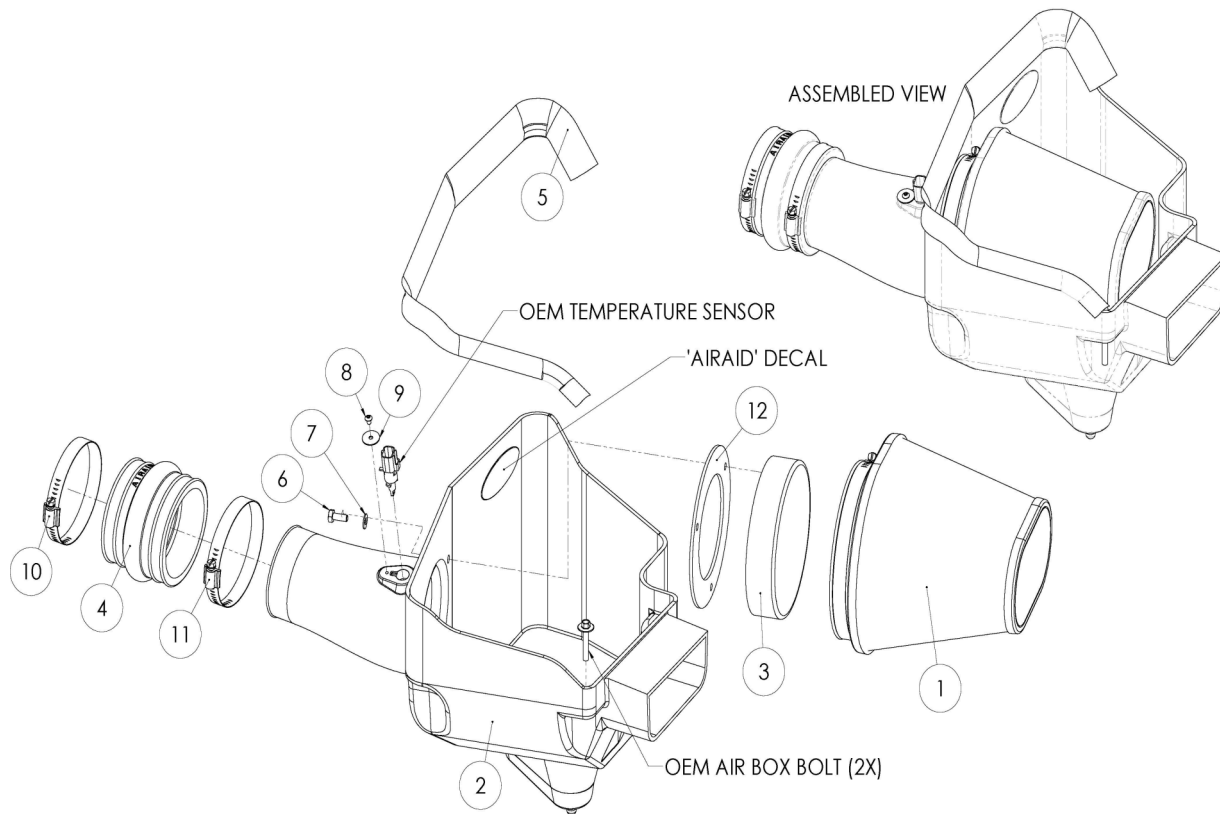

Component Identification

1.	Airaid Premium Filter	1
2.	Airaid Cool Air Box	1
3.	Filter Adapter	1
4.	Hump Hose Reducer	1
5.	Weather Strip 26 3/8"	1
6.	1/4"-20x5/8" Hex Head Bolt	3
7.	1/4" Flat Washer	3
8.	8-32 x 1/4" Button Head Bolt	1
9.	#8 x 3/4" O.D. Flat Washer	1
10.	#56 Hose Clamp	1
11.	#60 Hose Clamp	1
12.	Adapter Gasket	1
13. (Not Pictured)	Wire Harness Extension	1
14. (Not Pictured)	Black Zip Tie	1

Full color instructions can be viewed on our web site at Airaid.com. Use the **Product Search** function to find your part number, and click **View Details**.

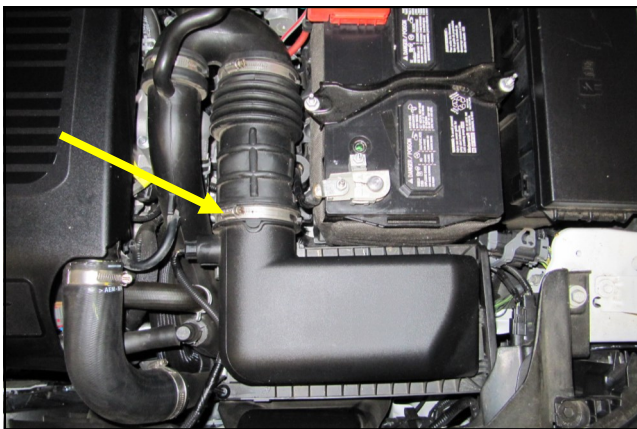

1. Disconnect the negative battery cable.
Loosen the clamp on the air box side of the intake tube.

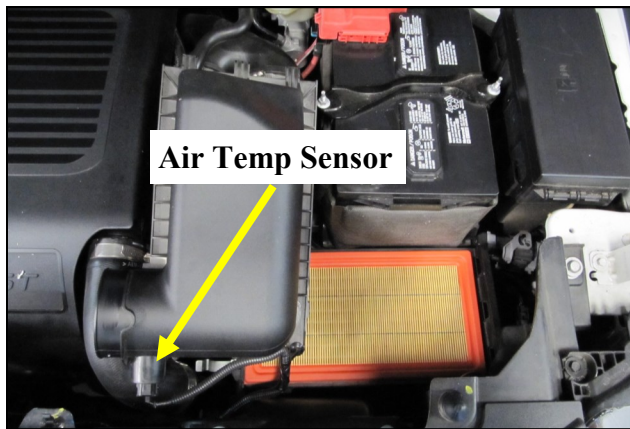

2. Unfasten the factory air box clips and separate the upper half of the air box from the intake assembly. Disconnect the air temperature sensor.

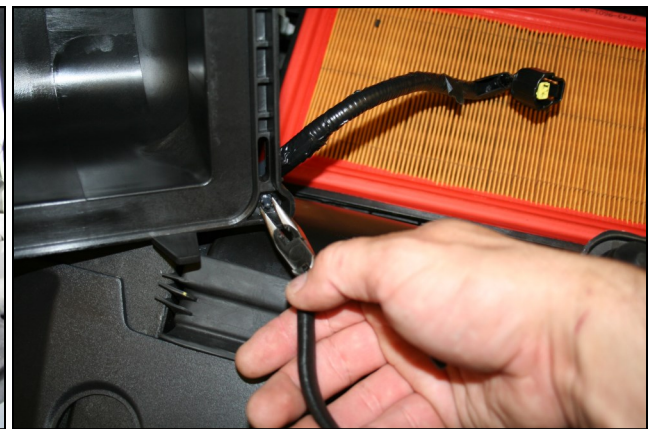

3. Using a pair of needle nose pliers, carefully compress the fins of the wiring harness anchor and pull it out of the air box lid.

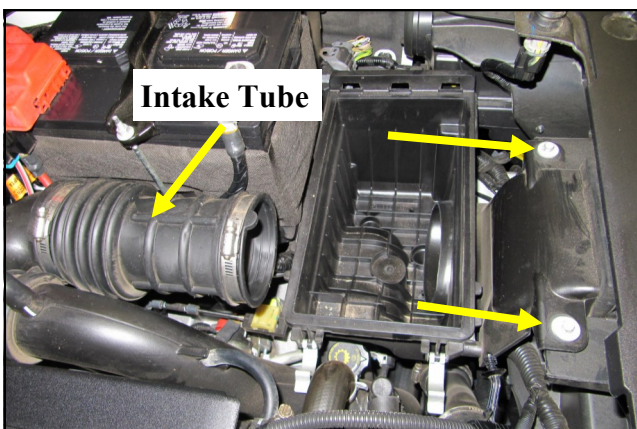

4. Using an 8mm socket, remove the two factory air box bolts and set aside. They will be reused in step 11. Loosen the second intake tube clamp and remove it from the vehicle.

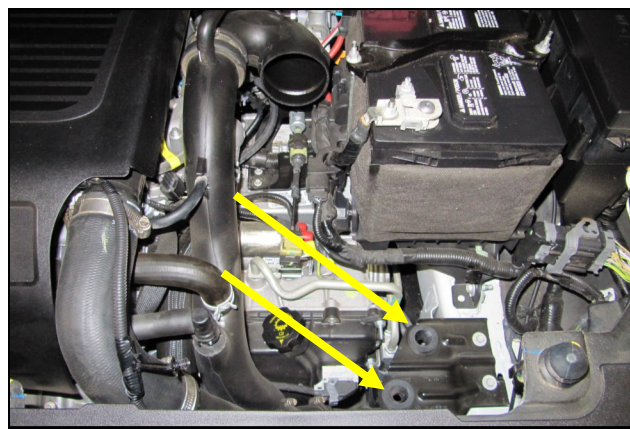

5. Remove the factory air box assembly from the vehicle. Be sure to retain the two air box mounting grommets.

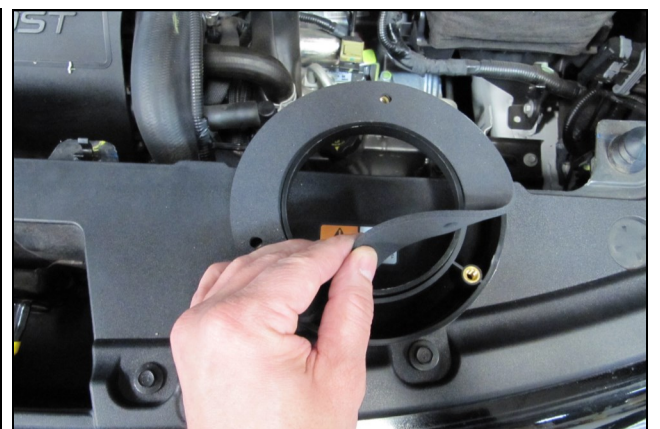

6. Prepare the Filter Adapter for installation by positioning the Adapter Gasket on the mounting side and lining up the holes.



7. Install the Filter Adapter to the inside of the Cool Air Box, using the three 1/4"-20 hex head bolts and 1/4" flat washers as shown.

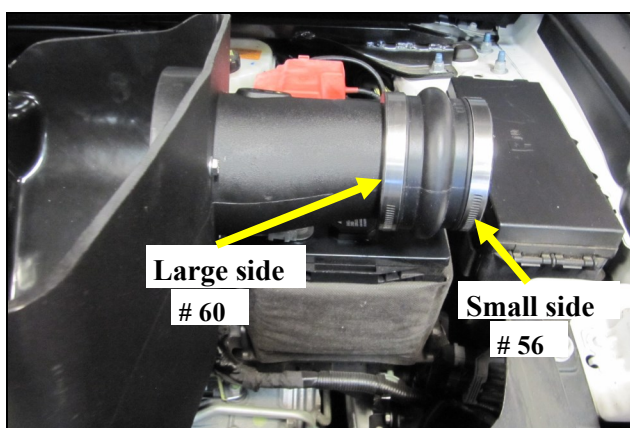

8. Install the Hump Hose, large side first onto the Intake tube. Loosely install the #56 Hose Clamp on the small side of the Hump Hose, and the #60 Hose Clamp on the Large side. Slide the Hump Hose and Clamps downward onto the tube, as far as it will go, creating a compact assembly as shown.

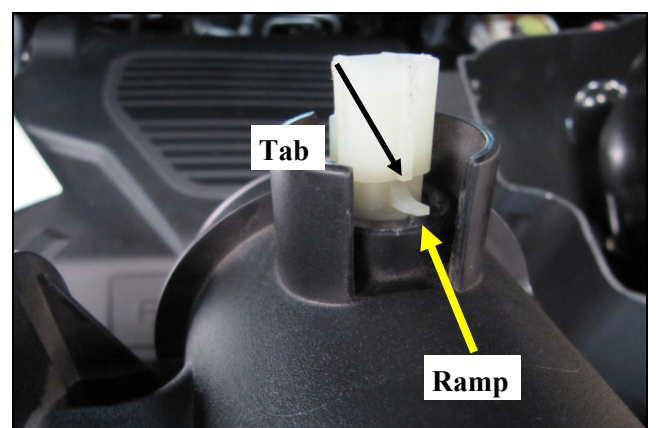

9. Remove the Air Temperature Sensor from the factory air box. Gently push back on the sensor so the locking tab will clear the ramp and rotate the sensor 1/4 turn counter clockwise. The sensor is now free and can be pulled out.

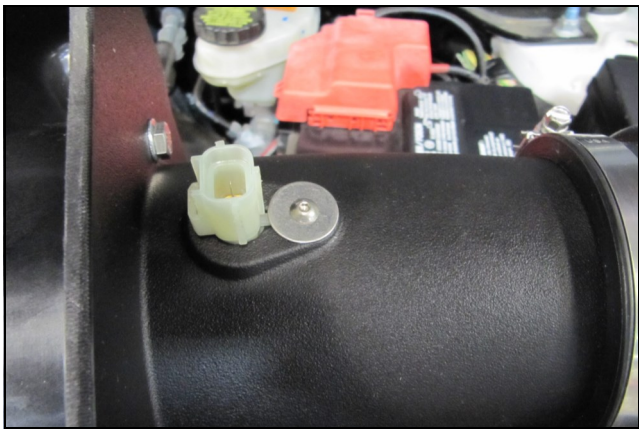

10. Transfer the factory Air Temperature Sensor into the Airaid Intake tube and align the sensor tab with the Groove in the tube. Secure the sensor to the tube using the 8-32 Button Head Bolt and the 3/4" washer.

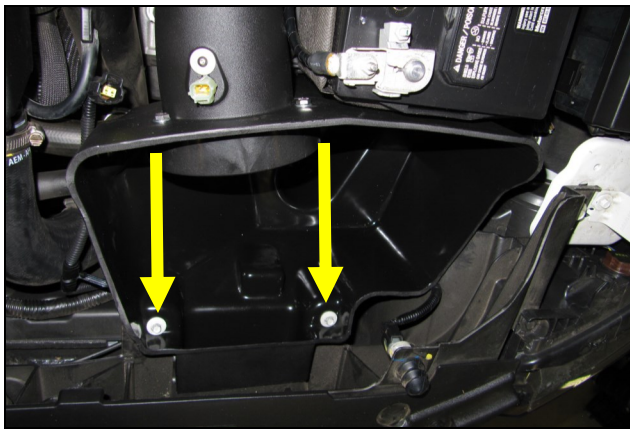

11. Place the Airaid Intake assembly in the original location of the Factory Air box and secure using the factory hardware from step 4. Slide the coupler and clamps onto 90 deg. Elbow pipe and tighten the clamps.

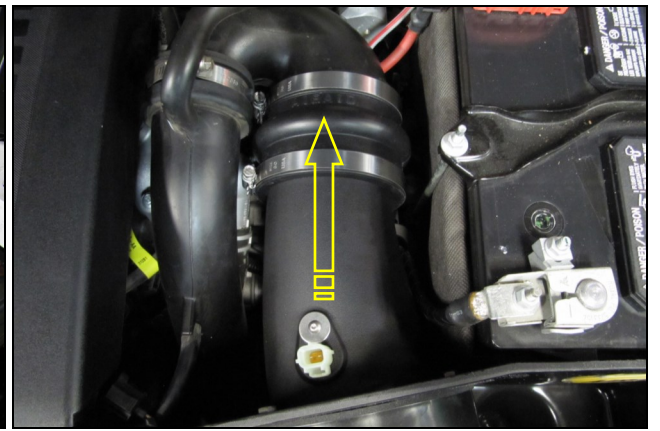

12. Slide the coupler and clamps onto 90 deg. Elbow pipe and tighten the clamps.

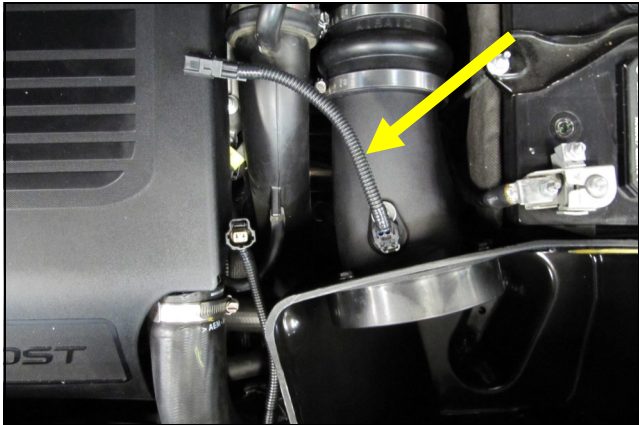

13. Connect the Wire Harness Extension to the air temperature sensor.

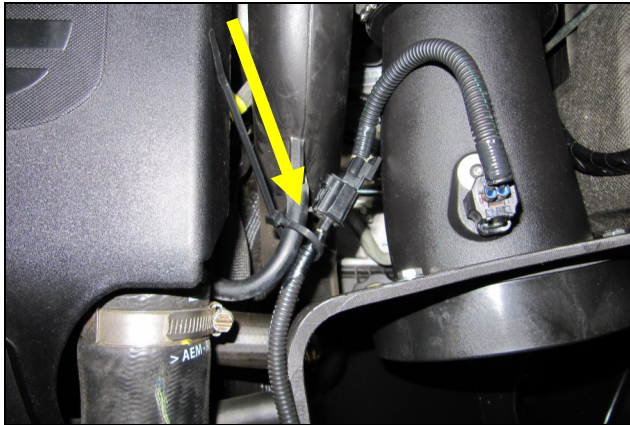

14. Plug the Harness Extension into the factory wire harness and secure it using the supplied Zip Tie. Trim the excess length

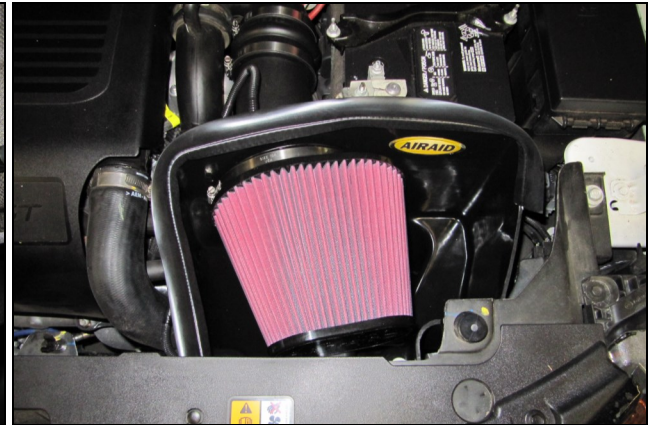

15. Install the Airaid Premium filter onto the Filter Adapter and tighten the clamp. Install the weather strip onto the top of the Air box as shown, with the contour rolling away from the filter.

Make sure there is no foreign material in the intake path. Make sure all clamps, hoses, bolts, and screws are tight. Double check the hood clearance! Reconnect the negative battery cable!

Thank you for purchasing the Airaid Intake System. Contact Airaid @ (800) 498-6951 8:00 AM - 5:00 PM MST weekdays for questions regarding fit or instructions that are not clear to you. Your Airaid Intake System was carefully inspected and packaged. Check that no parts are missing, or were damaged during shipping. If any parts are missing, contact Airaid. The air filter element is protected from direct exposure to water and debris; care should be taken not to drive through deep water. WATER INGESTION IS THE DRIVERS RESPONSIBILITY! The air filter is reusable and should be cleaned periodically.

FILTER IDENTIFICATION

720-479 Airaid Oiled Media
722-479 Airaid SynthaMax Dry Media - Black

721-479 Airaid SynthaMax Dry Media - Red
723-479 Airaid SynthaMax Dry Media - Blue

For your Oiled media filter we suggest using the AIRAID Filter Tune-Up Kit!

SynthaMax[®]

Do Not Oil



P/N 790-551 Aerosol Spray
P/N 790-550 Squeeze Spray



Synthamax Air Filters do not require oil. Service air filter as needed by cleaning with common non-petroleum all-purpose household cleaner and water. Simple Green®, Formula 409® or equivalent works great. Apply cleaner to outside of air filter and allow to soak. Then flush filter clean from the inside out with a garden hose and repeat steps if necessary. Do not apply high pressure water or air to clean filter. Allow filter to air dry and reinstall.