



## Installation Instructions

For Part Number:

450-331

2015 Ford Mustang

3.7L V6

### Component Identification

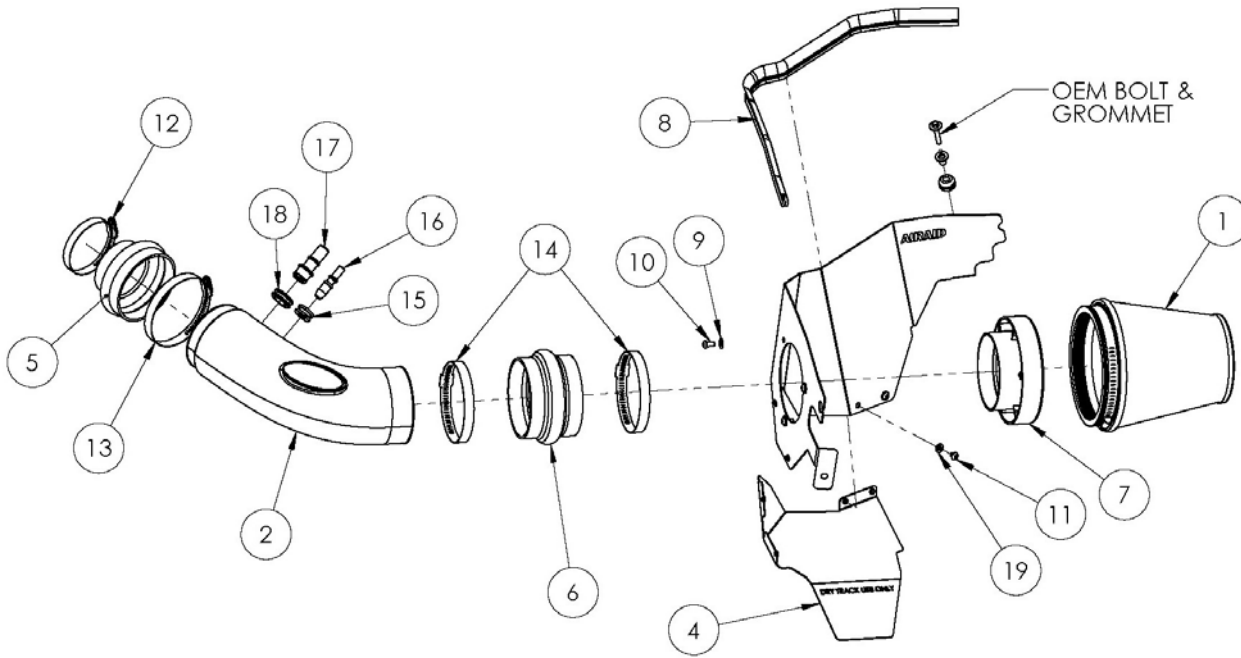

1	Airaid Track Day Filter	1
2	Airaid Intake Tube	1
3	Top Panel	1
4	Bottom Panel	1
5	Hump Hose Reducer	1
6	Hump Hose	1
7	Filter Adapter	1
8	Weatherstrip 23"	1
9	1/4" Flat Washer	3
10	1/4-20 X 1/2" Button Head Cap Screw	3
11	1/4"-20 x 1/4" Button Head Screw	4
12	#48 Hose Clamp	1
13	#64 Hose Clamp	1
14	#68 Hose Clamp	2
15	1/2" ID Grommet	1
16	3/8 Aluminum Fitting	1
17	5/8 Aluminum Fitting	1
18	13/16" ID Grommet	1
19	1/4" Lock Washer	4



Maximum performance potential requires custom tune.

Full color instructions can be viewed on our web site at [Airaid.com](http://Airaid.com). Use the **Product Search** function to find your part number, and click **View Details**.

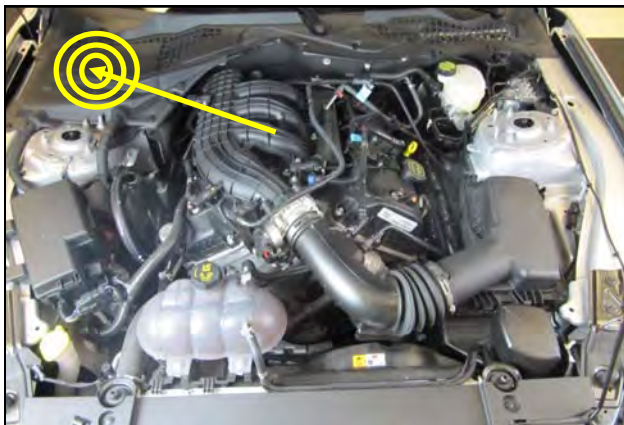

1. Remove the battery box cover in the cowl and disconnect the negative battery terminal.

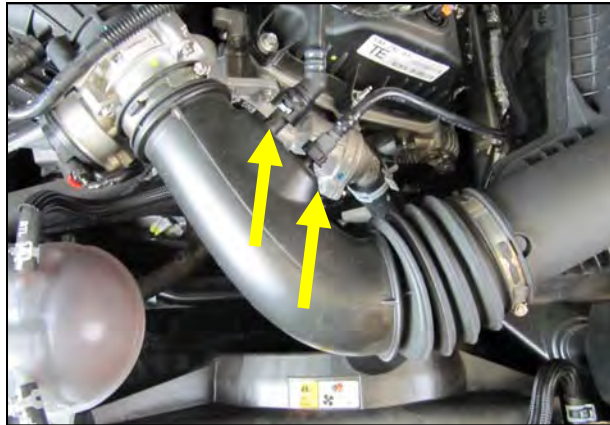

2. Disconnect the 2 breather lines from the intake tube, loosen the hose clamps and remove the factory intake.

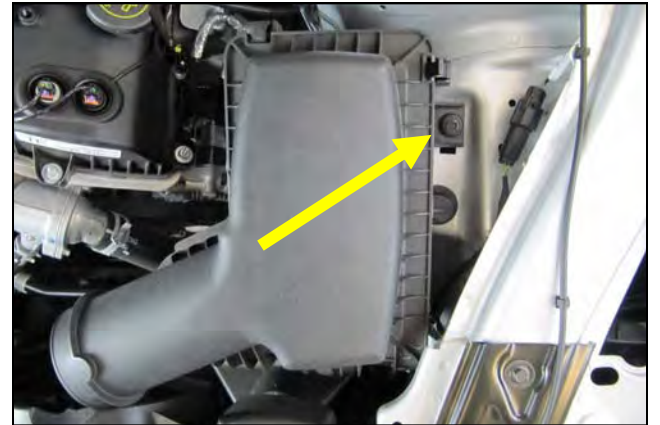

3. Remove the 6mm airbox mounting bolt in the inner fender and lift the entire airbox assembly out of the vehicle. Set the bolt aside for now. It will be reused.

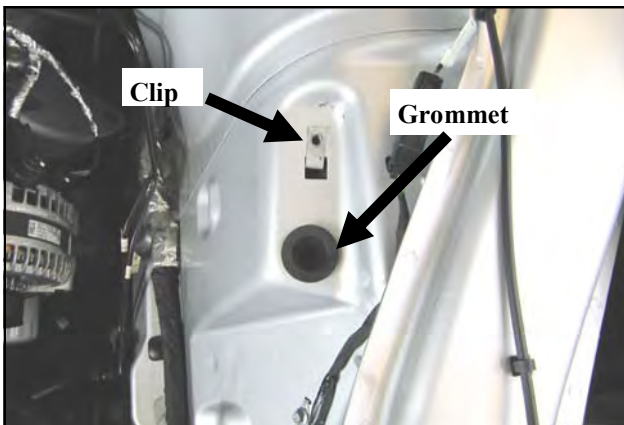

4. Be sure to retain the speed clip in the inner fender, but remove the grommet if it does not come out with the air box.



5. Install the Grommets and Aluminum Fittings into the Airaid Intake Tube.

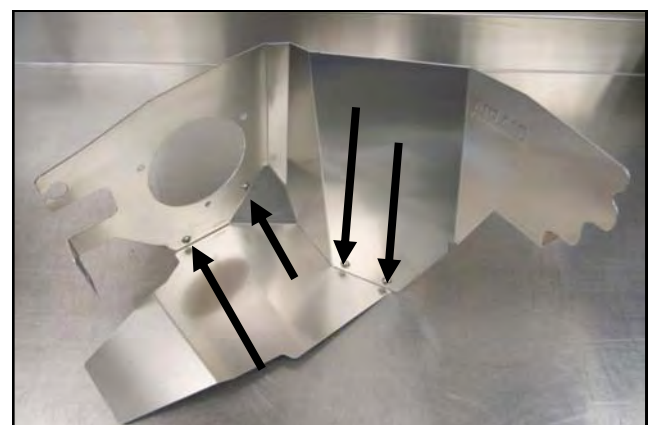

6. Remove the protective film from the Panels and create the assembly as shown using 4 1/4 -20 Button Head Screws and Lock washers.

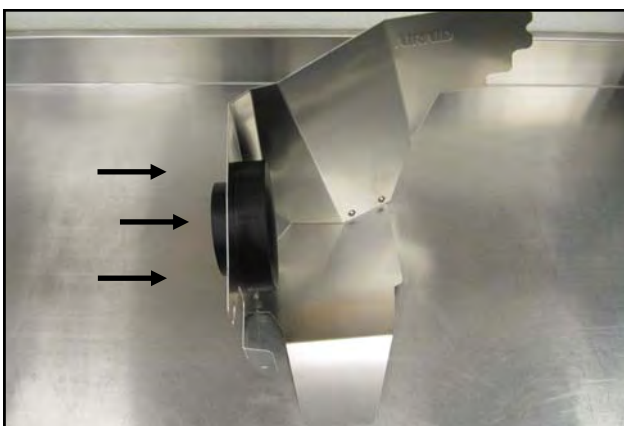

7. Install the Filter Adapter onto the Panel Assembly as shown, using the three 1/4-20 Button Head Screws and Flat Washers.



8. Transfer the OEM air box grommet and anti-crush sleeve into the Panel assembly as shown.



9. Remove the drivers side fan shroud bolt and set it aside.



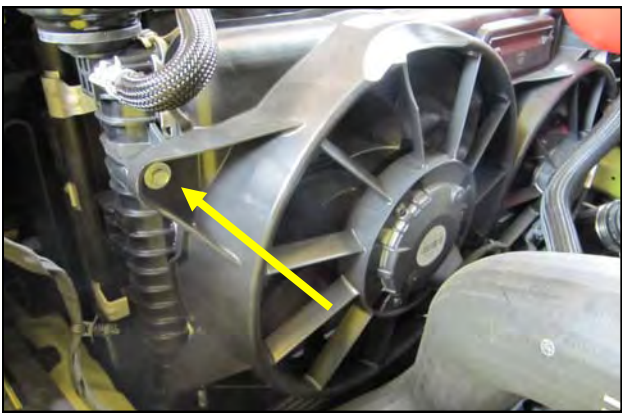

10. Remove the drivers side, upper fan shroud bolt and set it aside.

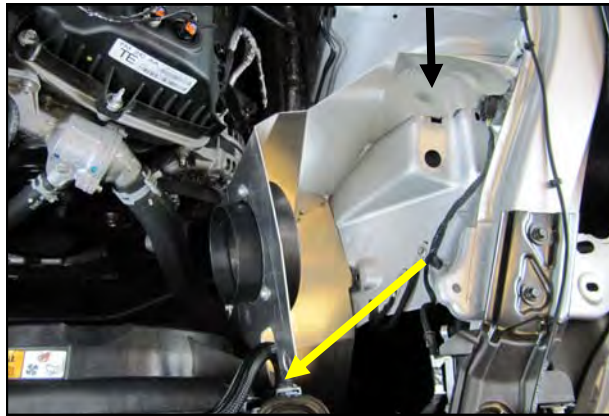

11 Install the Panel assembly into the engine compartment as shown and secure using the OEM hardware removed in steps 3 and 11.

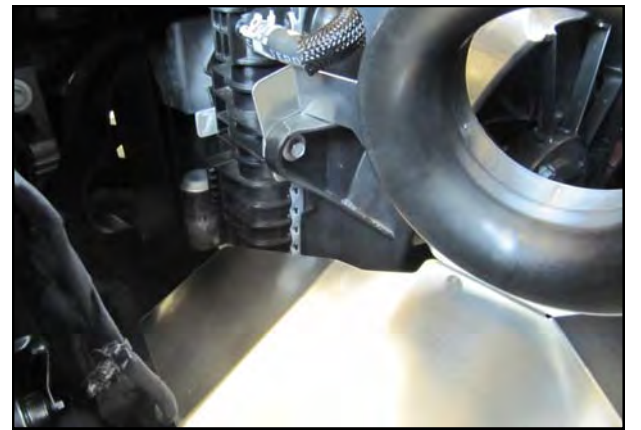

12 When properly installed, the Panel tab resides behind the fan shroud as shown.

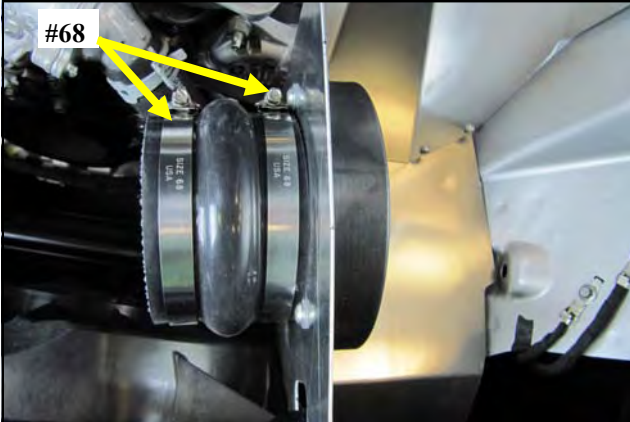

13. Slide the Hump Hose with two, #68 Clamps onto the Filter Adapter.



14. Slide the Reducer with one #64 and one #48 clamp onto the throttle body as shown.



15. Install the Airaid Tube into the Hump Hose and Reducer as shown. Tighten all four Hose Clamps at this time.

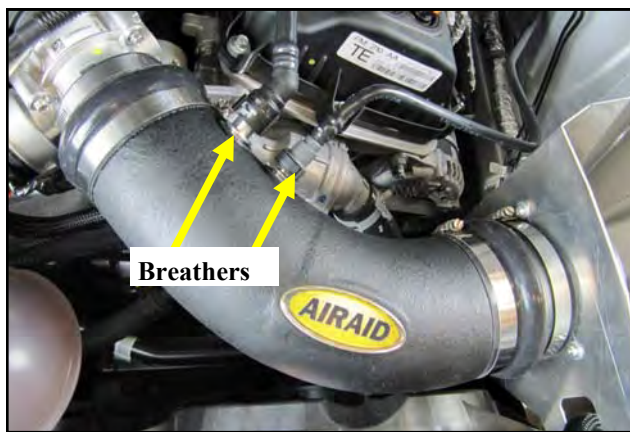

16. Reconnect the breathers to the Aluminum Fittings in the Airaid Tube.

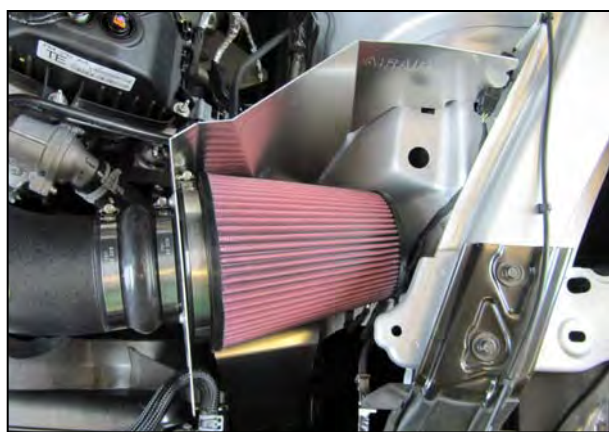

17. Install the Airaid Premium Filter onto the Filter Adapter.



18. Install the weatherstrip on top of the Panel assembly as shown with the contour rolling away from the filter.



19. Double check your work. Make sure all clamps, hoses, bolts, and screws are tight. Double check the hood clearance. Reconnect the negative battery cable and reinstall the cover.



For your Oiled media filter we suggest using the AIRAID Filter Tune-Up Kit!

Thank you for purchasing the Airaid Intake System. Contact Airaid @ (800) 498-6951 8:00 AM - 5:00 PM MST weekdays for questions regarding fit or instructions that are not clear to you. Your Airaid Intake System was carefully inspected and packaged. Check that no parts are missing, or were damaged during shipping. If any parts are missing, contact Airaid. The air filter element is protected from direct exposure to water and debris; care should be taken not to drive through deep water. WATER INGESTION IS THE DRIVERS RESPONSIBILITY! The air filter is reusable and should be cleaned periodically.