



Installation Instructions

For Part Numbers:

- 250-308 720-242 Airaid Oiled Media Filter
- 251-308 721-242 SynthaMax Dry Media Filter - Red
- 252-308 722-242 SynthaMax Dry Media Filter - Black
- 253-308 723-242 SynthaMax Dry Media Filter - Blue

2012-15 Chevrolet Camaro ZL-1
6.2L V8

Component Identification

1.	Airaid Premium Filter	1
2.	Silicone Tube Assembly	1
3.	Cold Air Box	1
4.	Filter Adapter	1
5.	Weatherstrip	1
6.	Split Loom, 4"	1
7.	#64 Hose Clamp	1
8.	#72 Hose Clamp	1
9.	#8-32 x 3/8" Button Head Screw	2
10.	1/4" Flat Washer	6
11.	1/4-20 x 1/2" Button Head Bolt	3
12.	Side Bracket	1
13.	M6 Flange Nut	2
14.	1/4" Lock Washer	1
15.	M6 x 1.0 x 12 Hex Head Bolt	1
16.	Lower Bracket	1
17.	1/4-20 x 3/4" Hex Head Bolt	1
18.	1/4" Nylock Nut	1
19.	Bumper	1
20.	8-32 x 5/8" Button Head Screw	1
21.	#8 Kep Nut	1
22.	#19 Speed Clamp	1
23.	M6 x 1.0 x 25 Hex Head Bolt	1

TUNE REQUIRED !

This intake system is not calibrated to any ECU and requires custom, vehicle specific tuning for proper drivability and to prevent costly engine damage. Installing off the shelf, plug in type programmers does not constitute Custom Tuning.

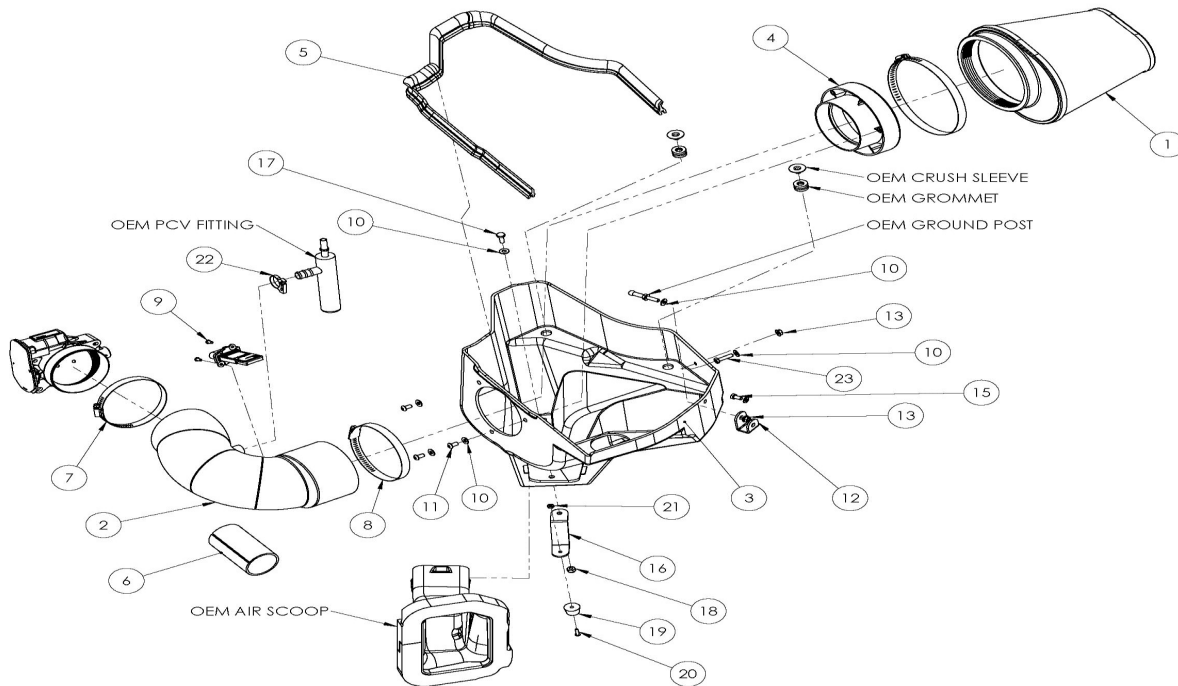

Full color instructions can be viewed on our web site at Airaid.com. Use the **Product Search** function to find your part number, and click **View Details**.



1. Disconnect The negative battery Terminal.
Disconnect the PCV line from the fitting on the factory intake tube. Loosen the intake clamps and remove the tube.

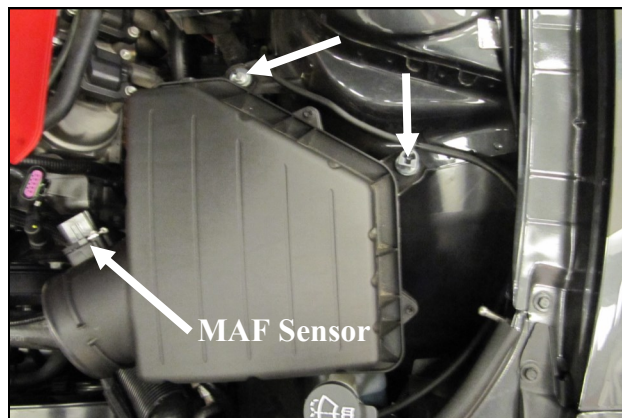

2. Disconnect the Mass Air Flow, or MAF sensor in the factory airbox. Locate the two 6mm nuts securing the airbox to the inner fender. Unseat the ground cable anchor covering the outer nut. Remove the nuts and set them aside. These fasteners will be reused later in step # 13.

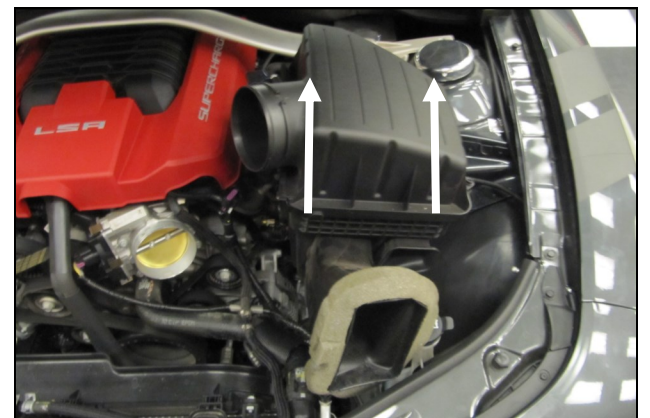

3. Lift the airbox and scoop assembly straight up, and out of the vehicle.



4. Use caution not to loose the factory grommet when you remove the air intake assembly. It will be needed if you ever want to reinstall the factory intake assembly.



5. Squeeze the sides of the factory intake scoop and remove it from the factory airbox. It will be reused in step #9.



6. Remove the two steel inserts, and grommets from the factory airbox. Save these pieces, they will be reused in step #7.

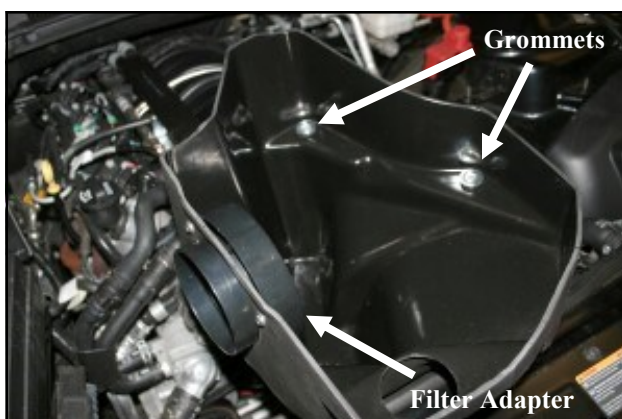

7. Reinstall the two steel sleeves and grommets into the Airaid Cold Air Box (#3). Next install the filter adapter (#4) into the CAB as shown using three 1/4-20 Button Head Bolts (#11), and 1/4" Fat Washers (#10). Refer to the line drawing above for details.

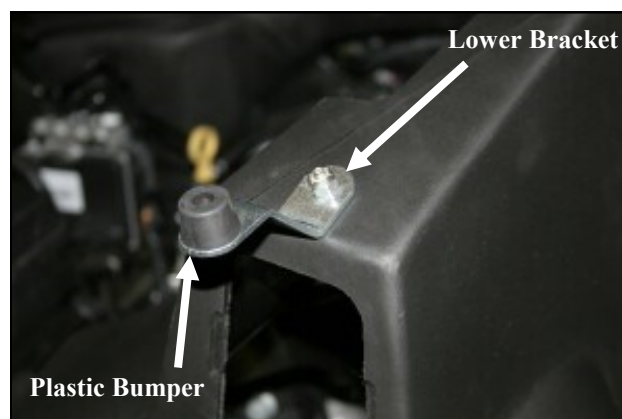

8. Turn the CAB upside down and mount the Lower Bracket (#16) to the bottom of the Cold Air Box using one 1/4-20x3/4" hex bolt (#17), 1/4" flat washer (#10), and 1/4" Nylock nut (#17) as shown. Next using one 8-32x5/8" button head screw (#9), and one #8 Kep nut (#21), attach the plastic bumper (#19) to the bracket as shown.



9. Reinstall the factory scoop into the Airaid Cold Air Box. It will snap into place.



10. Using a 10mm wrench, remove and save the ground lug from the driver's side inner fender. It will be reused in step #12.



11. Install the side bracket (#12) onto the inner fender as shown using the 6mmx12mm hex bolt (#15), and lock washer (#14).

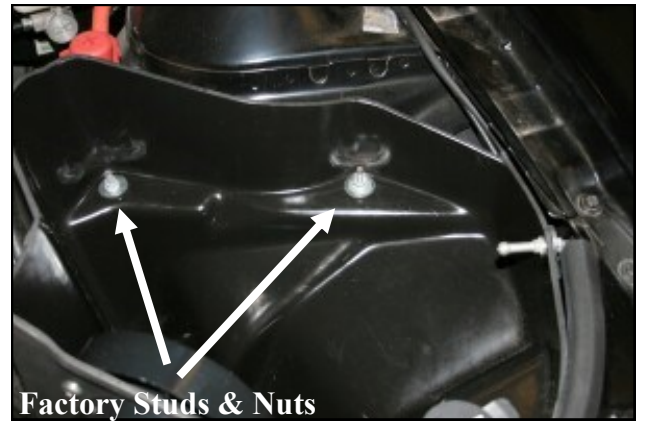

Factory Studs & Nuts

12. Install the Airaid Cold Air Box into the vehicle locating the factory grommets over the factory studs. Re-install the factory nuts from step #3 onto the studs. Reinstall the factory ground lug thru the Airbox wall.

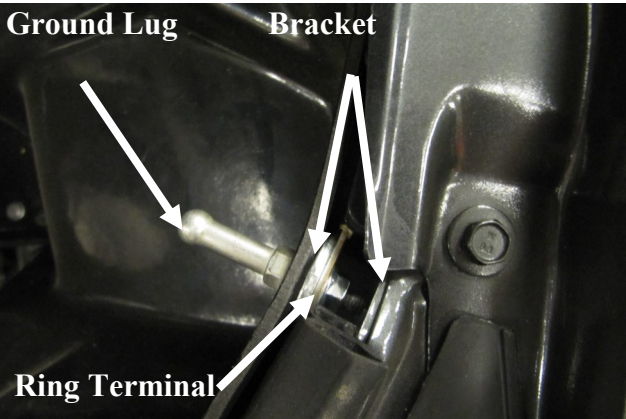

13. Install the ground lug into the Side bracket. Slide the ground cable ring terminal over the threads and secure using M6 Flange nut.

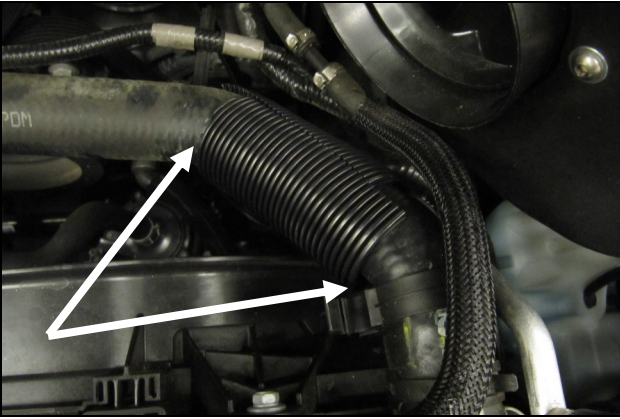

14. Slide the Split Loom (#6) over the coolant hose as shown.

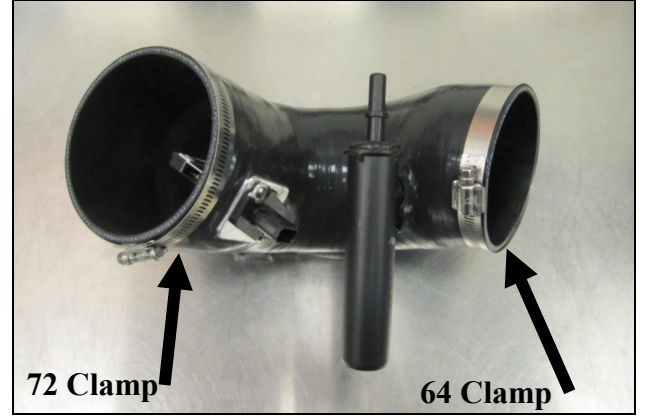

15. Transfer the Mass Air Flow sensor from the factory airbox into the Airaid Intake tube (#2) and secure it using the Two 8-32 x 3/8" Button Head Bolts (#9). Transfer the PCV fitting from the factory intake into the Airaid intake tube. Slide the Clamps onto the Intake tube As shown. Leave the clamps loose for now.

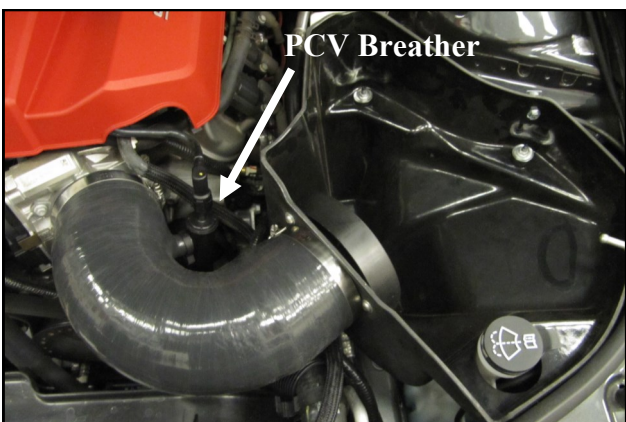

16. Install the Airaid Intake Tube assembly onto the Filter Adapter first, then onto the throttle body and tighten the clamps. Reconnect the PCV breather to the fitting and use the Speed Clamp (#22) secure the fitting in the tube. Reconnect the Mass Air Flow Sensor.

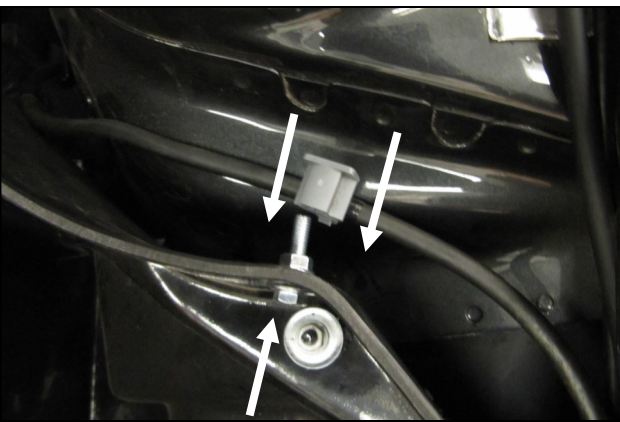

17. Using the Drill and the 1/4" bit, drill a bolt hole in the CAB opposite of the ground cable anchor. Insert the M6 x 1.0 x 25 mm Bolt (#23) with a 1/4" Washer on it into the CAB Hole, and secure it using the M6 Flange nut (#13). Slide the Cable anchor onto the M6 Bolt shank.



18. Install the Airaid Premium Filter (#1) onto the filter adapter and tighten the clamp. Next install the weather strip onto the top of the CAB. For ease of installation, start the front of the CAB near the radiator and work your way around towards the fender. Re connect the negative battery cable.

Thank you for purchasing the Airaid Intake System. Contact Airaid @ (800) 498-6951 8:00 AM - 5:00 PM MST weekdays for questions regarding fit or instructions that are not clear to you. Your Airaid Intake System was carefully inspected and packaged. Check that no parts are missing, or were damaged during shipping. If any parts are missing, contact Airaid. The air filter element is protected from direct exposure to water and debris; care should be taken not to drive through deep water. WATER INGESTION IS THE DRIVERS RESPONSIBILITY! The air filter is reusable and should be cleaned periodically.

FILTER IDENTIFICATION

720-242 Airaid Oiled Media
722-242 Airaid SynthaMax Dry Media - Black

721-242 Airaid SynthaMax Dry Media - Red
723-242 Airaid SynthaMax Dry Media - Blue

For your Oiled media filter we suggest using the AIRAID Filter Tune-Up Kit!



P/N 790-551 Aerosol Spray
P/N 790-550 Squeeze Spray



SynthaMax

Do Not Oil

Synthamax Air Filters do not require oil. Service air filter as needed by cleaning with common non-petroleum all-purpose household cleaner and water. Simple Green®, Formula 409® or equivalent works great. Apply cleaner to outside of air filter and allow to soak. Then flush filter clean from the inside out with a garden hose and repeat steps if necessary. Do not apply high pressure water or air to clean filter. Allow filter to air dry and reinstall.