



Installation Instructions

For Part Numbers:

300-175	720-440 Airaid Oiled Media Filter
301-175	721-440 SynthaMax Dry Media Filter - Red
302-175	722-440 SynthaMax Dry Media Filter - Black
303-175	723-440 SynthaMax Dry Media Filter - Blue

2005-07 Dodge Dakota
2006-07 Mitsubishi Raider

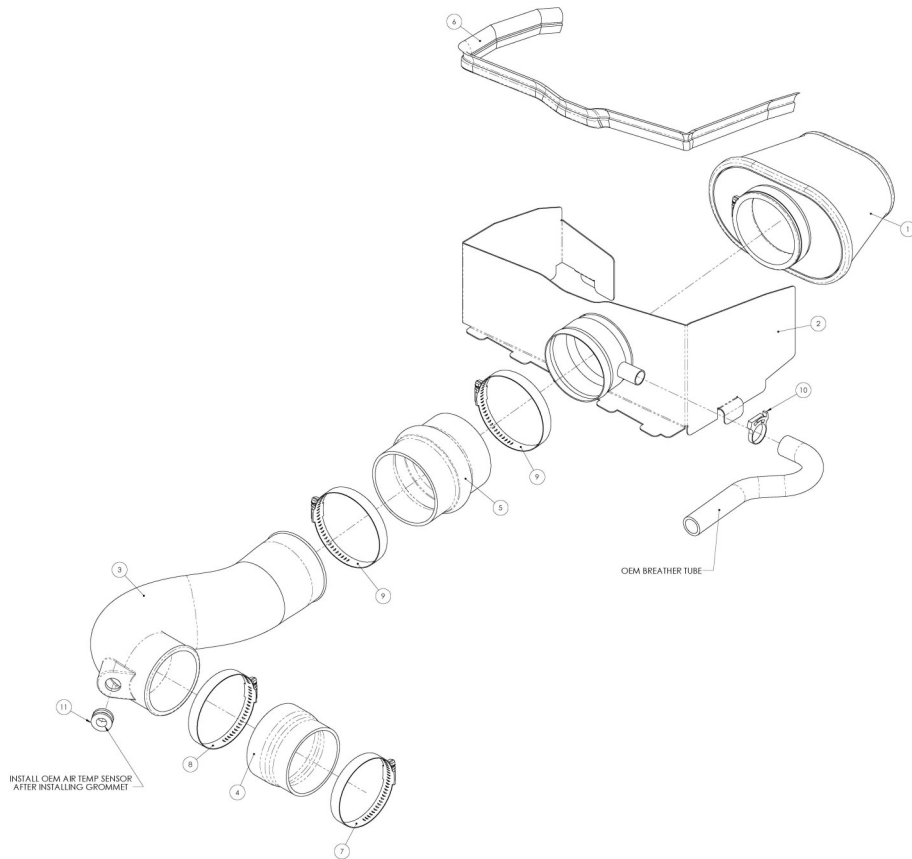

Component Identification

1.	Airaid Premium Filter	1
2.	Quick Fit Panel	1
3.	Airaid Intake Tube	1
4.	Reducing Coupler	1
5.	Urethane Hump Hose	1
6.	Weather Strip 27 1/2"	1
7.	#48 Hose Clamp	1
8.	#52 Hose Clamp	1
9.	#60 Hose Clamp	2
10.	#24 Speed clamp	1
11.	Grommet	1
12.	Airaid Decal	1

Full color instructions can be viewed on our web site at Airaid.com. Use the **Product Search** function to find your part number, and click **View Details**.

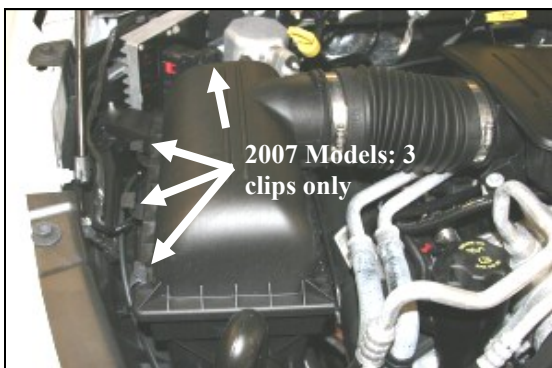

1. Disconnect the negative battery cable.
Unlatch the four clips (three on 2007 models) on the factory airbox.

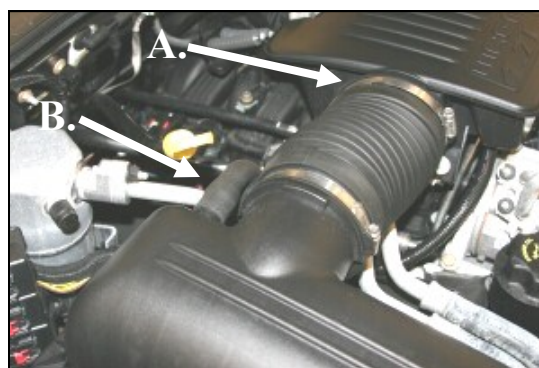

2. A.) Loosen the hose clamp on the resonator end of the intake tube. B.) Disconnect the breather hose from the factory airbox lid.



3. Remove the factory airbox lid and tube. Remove the factory air filter from the factory airbox base.

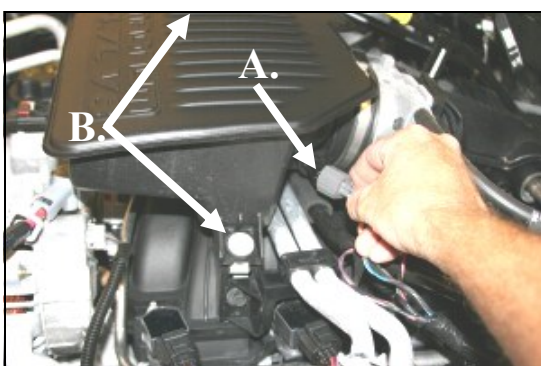

4. A.) Disconnect the Air Intake Temperature (AIT) sensor wiring harness.
B.) Using a 10mm socket, remove the two bolts (one on each side) that hold the resonator to the intake manifold, and then remove the resonator.



5. 2007 Models only: A.) Using a flat blade screwdriver, gently pry and remove one factory clip from the passenger side rear of the airbox base. (see arrow above)
B.) Re-install the clip onto the rear of the factory airbox base (see arrow above).

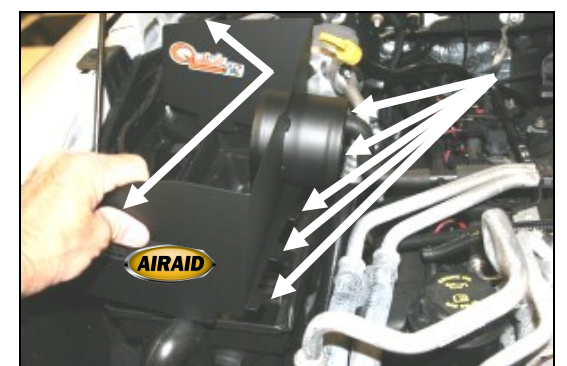

6. Slip the five tabs of the Quick fit panel (#2) through the slots on the airbox base. Adjust the panel for fit, then re-latch two of the factory clips onto the panel. Apply the Airaid Foil Decal onto the Panel as shown.

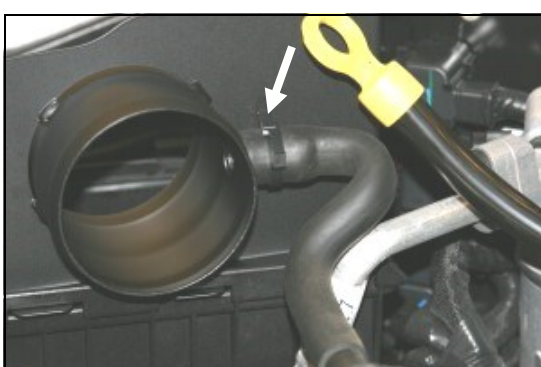

7. Re-connect the factory breather hose onto the Quick Fit Panel and secure with the #24 speed clamp (#10) as shown.



8. Install the grommet (#11) into the Airaid Intake Tube (#3).



9. Carefully twist and remove the AIT sensor from the factory resonator.

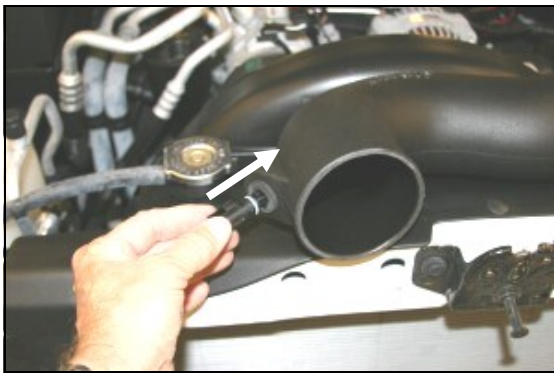

10. Carefully install the AIT sensor into the grommet in the Airaid Intake Tube. Make sure it goes all the way in.

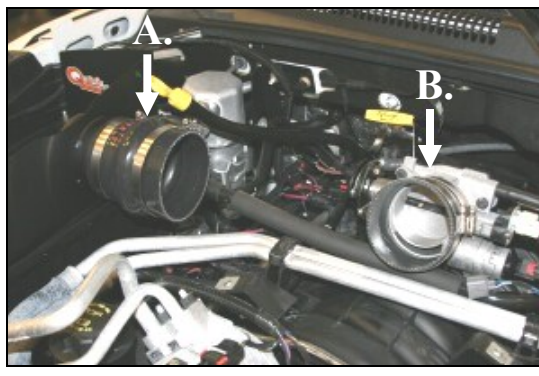

11. A.) Install the urethane hump hose (#5) and two #60 hose clamps (#9) onto the Quick fit Panel.
B.) Install the reducing coupler (#4) onto the throttle body using one #52 hose clamp (#8) on the tube side, and one #48 hose clamp (#7) on the throttle body side. (Leave the clamps loose for now.)

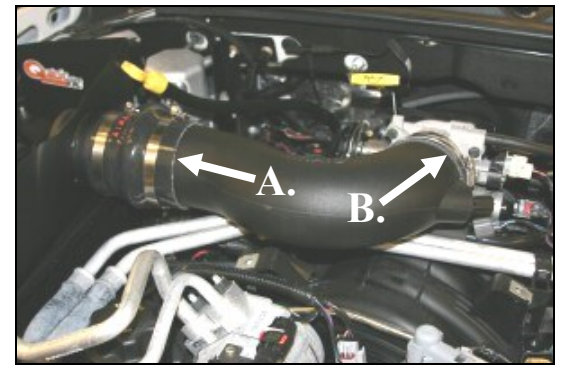

12. A.) Slide the Airaid Intake Tube into the hump hose first.
B.) Slide the other end of the Airaid intake tube into the reducing coupler on the throttle body. Adjust the tube for fit, and tighten the clamps.



13. Reconnect the AIT sensor wiring harness to the sensor.

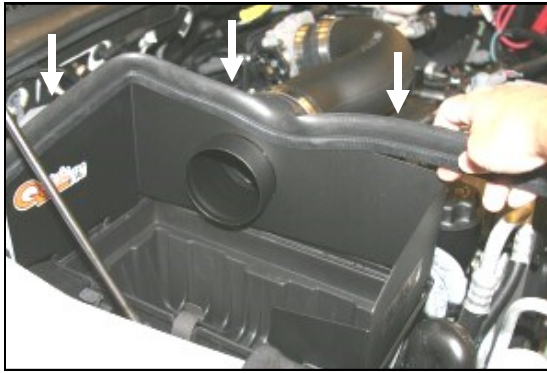

14. Install the weather strip (#6) onto the top of the Quick Fit Panel as shown. (Hint: Start at one end and work towards the other.)



15. Install the Airaid Premium Filter (#1) onto the Quick Fit Panel as shown, and tighten the clamp.

16. Double check your work!

Make sure there is no foreign material in the intake path. Make sure all clamps, hoses, bolts, and screws are tight.

17. Reconnect the negative battery cable!

Thank you for purchasing the Airaid Intake System. Contact Airaid @ (800) 498-6951 8:00 AM - 5:00 PM MST weekdays for questions regarding fit or instructions that are not clear to you. Your Airaid Intake System was carefully inspected and packaged. Check that no parts are missing, or were damaged during shipping. If any parts are missing, contact Airaid. The air filter element is protected from direct exposure to water and debris; care should be taken not to drive through deep water. WATER INGESTION IS THE DRIVERS RESPONSIBILITY! The air filter is reusable and should be cleaned periodically.

FILTER IDENTIFICATION

720-440 Airaid Oiled Media
722-440 Airaid SynthaMax Dry Media - Black

721-440 Airaid SynthaMax Dry Media - Red
723-440 Airaid SynthaMax Dry Media - Blue

For your Oiled media filter we suggest using the AIRAID Filter Tune-Up Kit!



P/N 790-551 Aerosol Spray
P/N 790-550 Squeeze Spray



SynthaMax

Do Not Oil

Synthamax Air Filters do not require oil. Service air filter as needed by cleaning with common non-petroleum all-purpose household cleaner and water. Simple Green®, Formula 409® or equivalent works great. Apply cleaner to outside of air filter and allow to soak. Then flush filter clean from the inside out with a garden hose and repeat steps if necessary. Do not apply high pressure water or air to clean filter. Allow filter to air dry and reinstall.