



Installation Instructions

For Part Numbers:

310-164	700-456 Airaid Oiled Media Filter
311-164	701-456 SynthaMax Dry Media Filter - Red
312-164	702-456 SynthaMax Dry Media Filter - Black
313-164	703-456 SynthaMax Dry Media Filter - Blue

1997-2002 Jeep Wrangler (TJ)
2.5L I4

Component Identification

1.	Airaid Premium Filter	1
2.	MAF Panel	1
3.	Bottom Panel	1
4.	Airaid Intake Tube	1
5.	Hump Hose	1
6.	Reducer	1
7.	Weather Strip 27"	1
8.	6-32x5/16" Screw	4
9.	#6 Flat Washer	4
10.	6-32 Keps Nut	4
11.	1/4"X20x1/2" Button Head Bolt	2
12.	1/4" Flat Washer	3
13.	1/4" Fender Washer	1
14.	1/4-20 Nylock Nut	1
15.	M6x12mm Hex Bolt	1
16.	#44 Hose Clamp	2
17.	#72 Hose Clamp	2
18.	L-Bracket	1
19.	Grommet	1
20.	Airaid Foil Decal	1

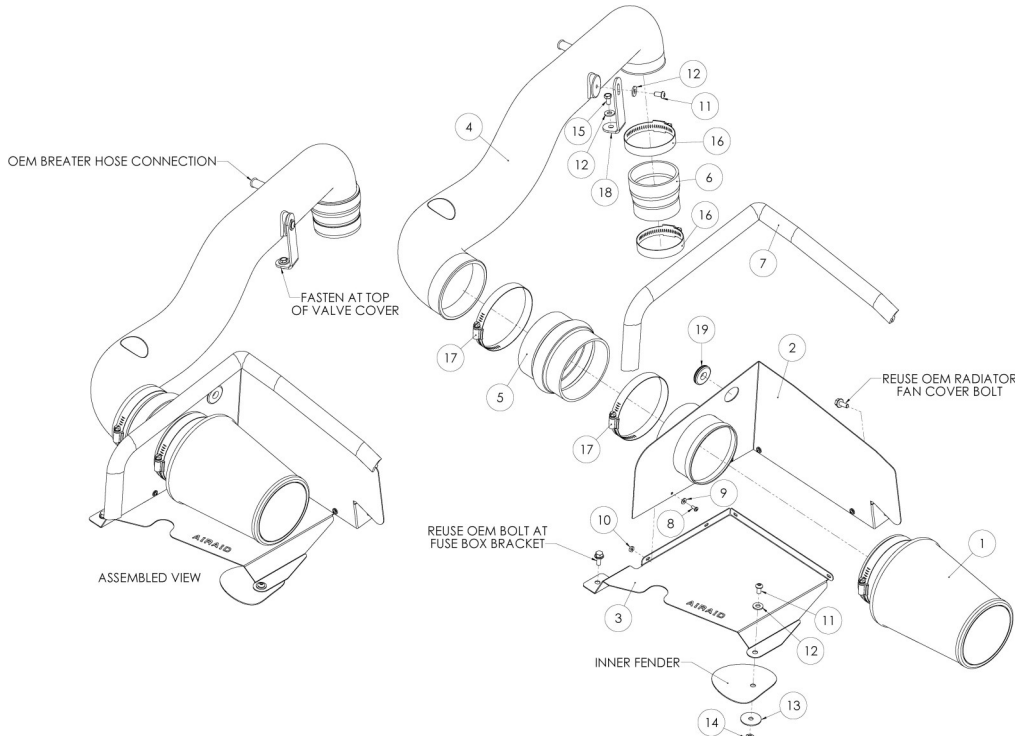

Full color instructions can be viewed on our web site at Airaid.com.



1. **Disconnect the negative battery cable.** Loosen the hose clamp that holds the factory intake tube to the resonator.



2. Unlatch the clips on the factory air cleaner lid, next remove the lid, and tube as an assembly.



3. Loosen the clamp that holds the resonator to the throttle body.



4. Disconnect the breather hose from the resonator.



5. Remove the bolt that holds the resonator to the valve cover.



6. Remove the resonator from the vehicle.



7. Remove three bolts from inside the lower air cleaner box and remove it from the vehicle.

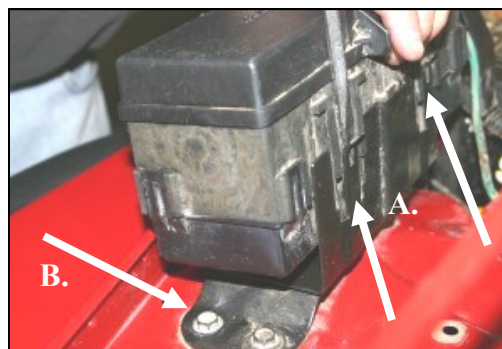

8. A.) On the right fender, pry two tabs away from the fuse box, lift it up and set it off to the side. B.) Next, remove and save the outside bolt from the fuse box mount. It will be re-used in step #14.



9. Remove one bolt from the passenger side radiator fan shroud and save it for step #15.



10. Remove and save the bolt from the passenger side radiator support brace. It will be re-used in step #13.



11. Assemble the two Cool Air Dam panels (#2) & (#3) using the four 6-32 screws (#8), #6 flat washers (#9), and nuts (#10). Apply the Airaid Foil Decal onto the Panel as shown.

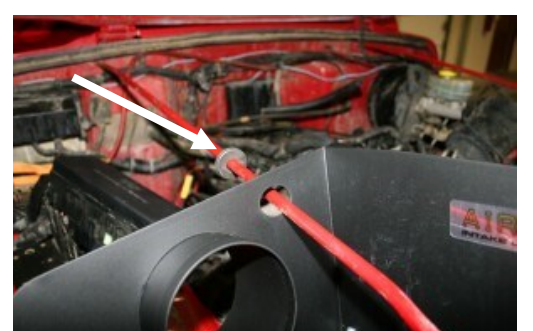

12. Slide the rubber grommet (#19) over the radiator support, followed by the assembled CAD. Use caution not to scratch the paint on the support rod.

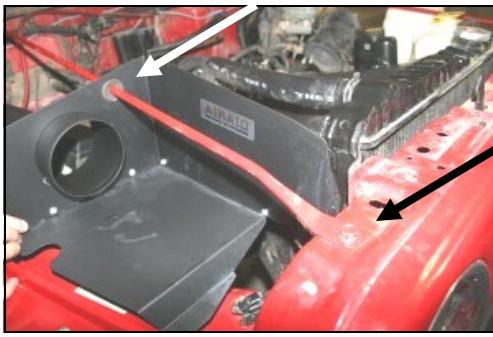

13. Align the CAD over the mounting holes, and re-install the factory bolt from step #10 in the radiator support. Slide the grommet forward into the hole in the CAD as shown.

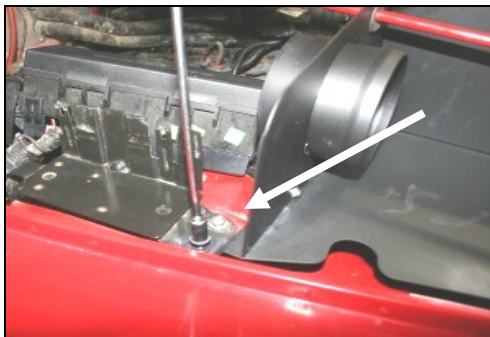

14. Re-install the factory bolt from step # 8 thru the CAD, and into the fender. Re-install the fuse box on the factory mount.

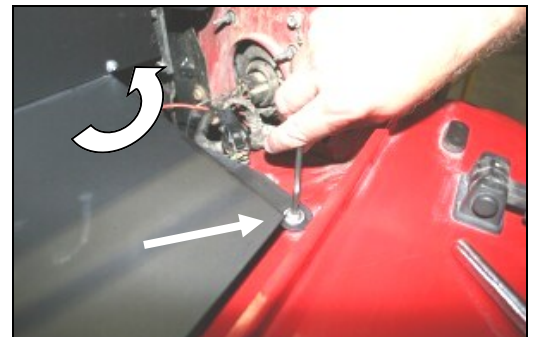

15. Install the supplied 1/4" button head bolt (#11), and 1/4" washer (#12), thru the CAD, with the 1/4" fender washer (#13) and nut (#14), on the bottom of the fender. Re-install the factory bolt in the radiator shroud removed in step #9.

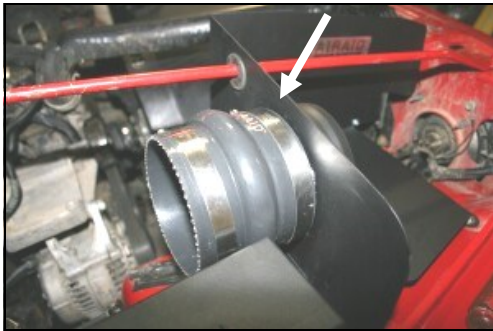

16. Install the hump hose (#5) onto the back side of the CAD tube using two #72 hose clamps (#17). Tighten only the hose clamp on the metal tube for now.



17. Install the reducer (#6) onto the throttle body using two #44 hose clamps (#16). Tighten only the hose clamp on the throttle body for now..



18. Install the L-bracket (#18), onto the Airaid Intake Tube (#4), using one 1/4" button head bolt (#11), and flat washer (#12). Leave the bolt loose for now.



19. A.) Install the large end of the Airaid Intake Tube into the hump hose.
B.) Now slide the small end into the reducer on the throttle body.

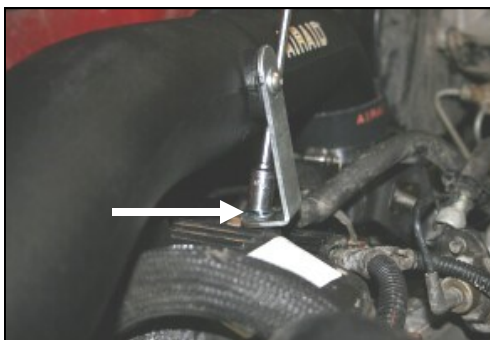

20. Install the 6mm bolt (#15), and 1/4" flat washer (#12), thru the L-bracket, and into the valve cover, adjust for fit, and then tighten all hose clamps, and bolts.



21. Re-connect the breather hose to the Airaid Intake Tube.



22. Install the Airaid Premium Filter (#1) onto the CAD tube and tighten the hose clamp. Next, install the weather strip onto the top of the CAD as shown, starting at the fender, working your way towards the radiator.

23. Double check your work!

Make sure there is no foreign material in the intake path. Make sure all clamps, hoses, bolts, and screws are tight. Periodically check the tightness of all hose clamps, nuts, and bolts.

24. Reconnect the negative battery cable!

Thank you for purchasing the Airaid Intake System. Contact Airaid @ (800) 498-6951 8:00 AM - 5:00 PM MST weekdays for questions regarding fit or instructions that are not clear to you. Your Airaid Intake System was carefully inspected and packaged. Check that no parts are missing, or were damaged during shipping. If any parts are missing, contact Airaid. The air filter element is protected from direct exposure to water and debris; care should be taken not to drive through deep water. WATER INGESTION IS THE DRIVERS RESPONSIBILITY! The air filter is reusable and should be cleaned periodically.

FILTER IDENTIFICATION

700-456 Airaid Oiled Media
702-456 Airaid SynthaMax Dry Media - Black

701-456 Airaid SynthaMax Dry Media - Red
703-456 Airaid SynthaMax Dry Media - Blue

For your Oiled media filter we suggest using the AIRAID Filter Tune-Up Kit!



P/N 790-551 Aerosol Spray
P/N 790-550 Squeeze Spray



SynthaMax

Do Not Oil

Synthamax Air Filters do not require oil. Service air filter as needed by cleaning with common non-petroleum all-purpose household cleaner and water. Simple Green®, Formula 409® or equivalent works great. Apply cleaner to outside of air filter and allow to soak. Then flush filter clean from the inside out with a garden hose and repeat steps if necessary. Do not apply high pressure water or air to clean filter. Allow filter to air dry and reinstall.