



Installation Instructions

For Part Numbers:

400-246	720-472 Airaid Oiled Media Filter
401-246	721-472 SynthaMax Dry Media Filter - Red
402-246	722-472 SynthaMax Dry Media Filter - Black
403-246	723-472 SynthaMax Dry Media Filter - Blue

1999-03 Ford F-250/F-350 Super Duty
7.3L V8 Power Stroke

Component Identification

1.	Airaid Premium Filter	1
2.	Airaid Intake Tube	1
3.	Bottom Panel	1
4.	Side Panel	1
5.	Air Dam	1
6.	CAD Lid	1
7.	Battery Mat	1
8.	Battery Tie Down	1
9.	Weather Strip 29"	1
10.	Silicone Hump Hose	1
11.	1/4-20 J Bolt	2
12.	Bracket 140	2
13.	#64 Hose Clamp	2
14.	1/4-20 x 1/2" Button Head Bolt	10
15.	1/4" Flat washer	10
16.	1/4-20 Flange nut	5
17.	8-32 Thread Cutting Screw	14
18.	6mm Flange Nut	1
19.	Airaid Decal	1

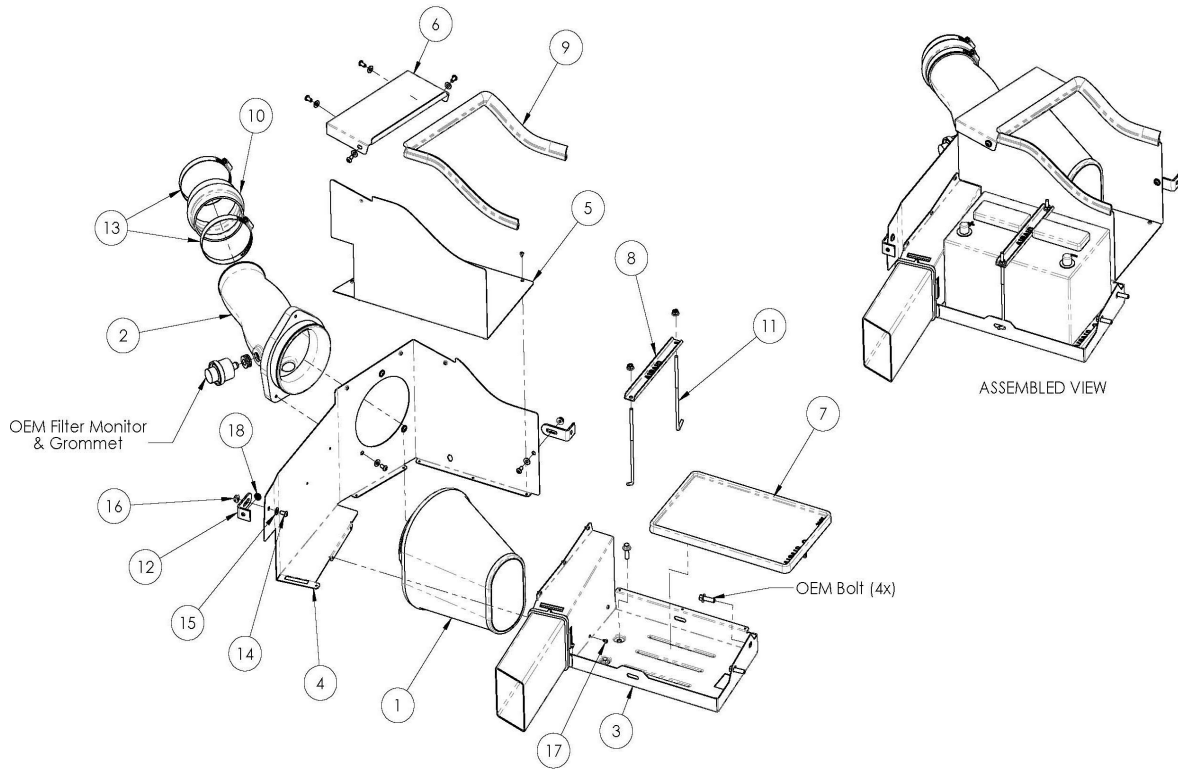

Full color instructions can be viewed on our web site at Airaid.com.



1. **Disconnect the battery cables.**
Disconnect both the Drivers side and Passenger side battery cables.



2. **A.)** Disconnect the filter minder in the top of the airbox.
B.) Loosen the clamp on the turbo inlet and unclip the airbox top to remove the factory intake and airfilter.

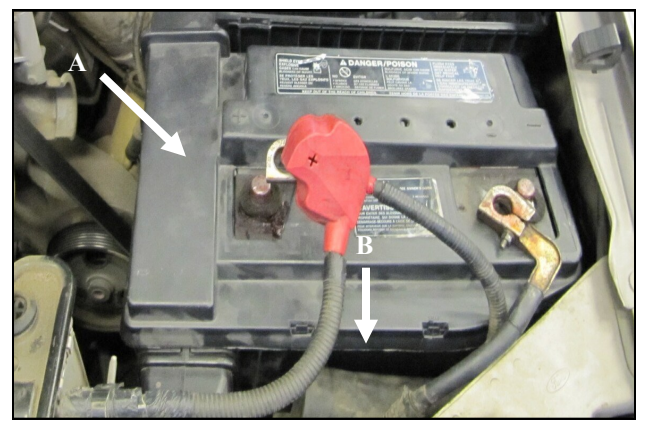

3. **A.)** Remove the factory battery cover.
B.) Using a 5/16" socket, remove the factory battery hold down.



4. **A.)** Disconnect the air temp sensor.
B.) Remove the four bolts securing the air/battery box assembly to the vehicle. Remove the assembly and set aside. The bolts and air inlet will be reused.

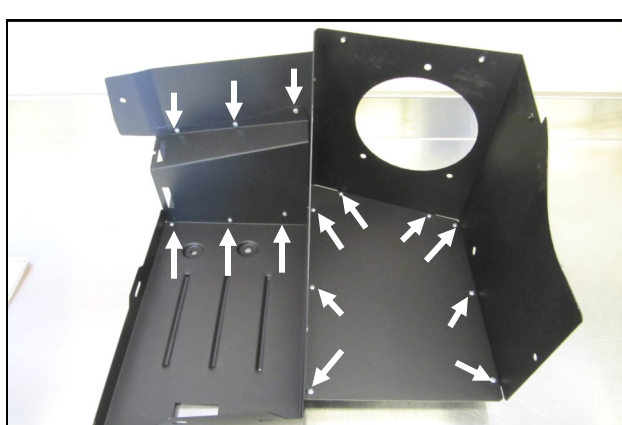

5. Create the Cool Air Dam, or CAD assembly as shown using the Bottom Panel (#3), Side Panel (#4), and the 8-32 Thread Cutting Screws (#17). NOTE: Panel tabs are to be on the bottom of its mating panel.

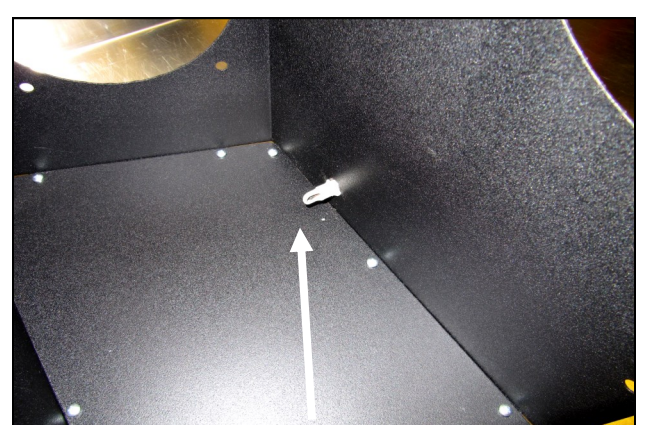

6. Transfer the air temp sensor from the factory airbox into the CAD assembly.

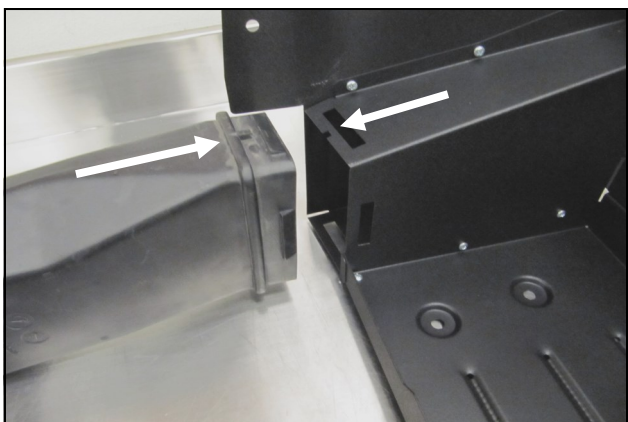

7. Transfer the air inlet from the factory airbox assembly into the CAD assembly. The air inlet has an indexing tab that mates with a slot in the Panel. NOTE: Vehicles built "BEFORE 12/7/98" do not have this air inlet design. This intake can be used with or without the factory inlet. It is available from Ford as a special order part. Ford Part number: **9C675 Engine Air Box Tube 7.3L "FROM 12/7/98"**

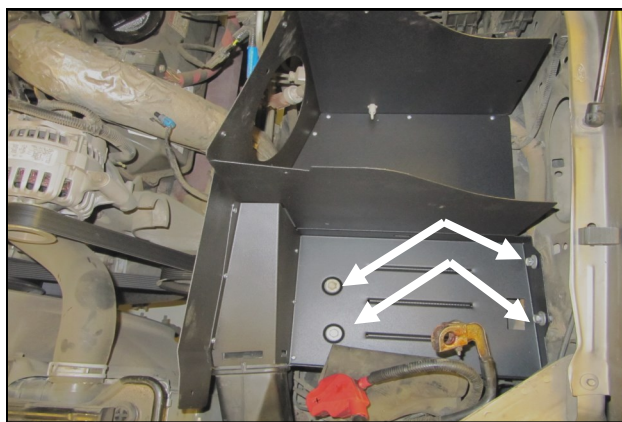

8. Place the CAD assembly in the engine compartment and start the four factory bolts from step 4. Leave the bolts loose for now.

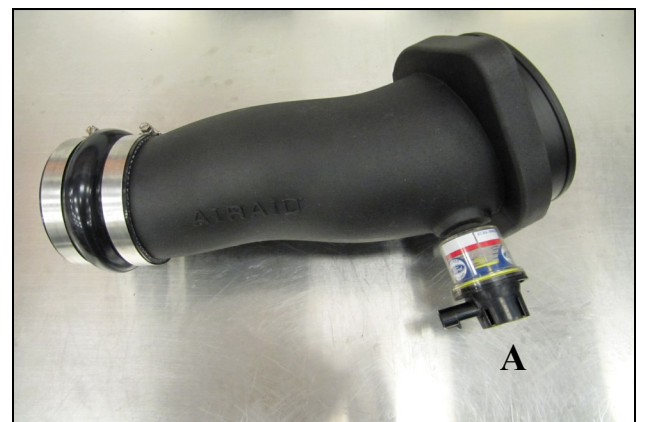

9. Create the Tube assembly. **A.)** Transfer the factory grommet and filter minder into the Airaid Intake Tube (#2). **B.)** Slide the Hump Hose (#10) and Clamps (#13) onto the Tube as shown. Leave the clamps loose for now.

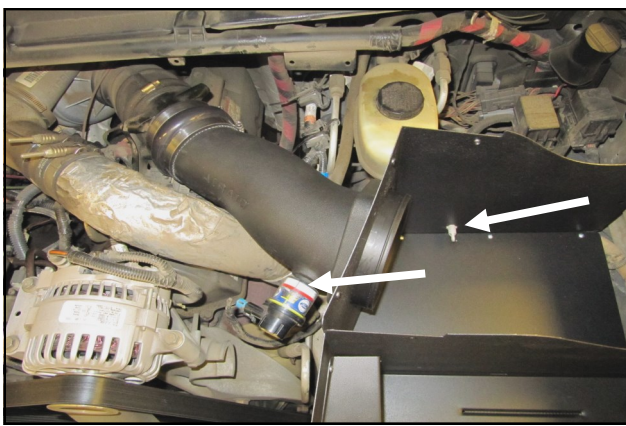

10. Insert the Airaid Intake Tube into the CAD assembly, then slide the Hump Hose onto the turbo inlet and tighten the Clamps. Reconnect the filter minder and the air temp sensor.

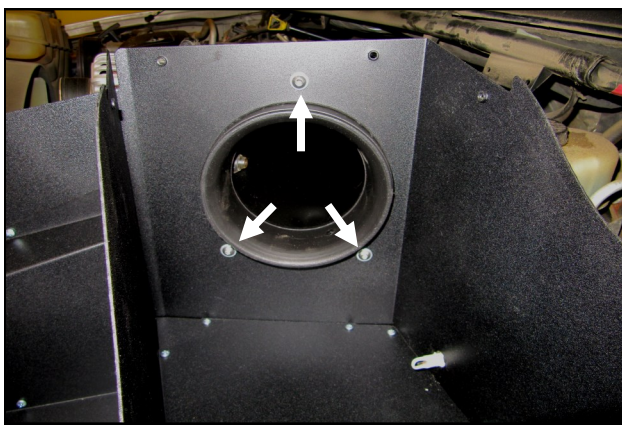

11. Secure the Intake Tube to the CAD assembly using three 1/4-20 Button Head bolts (#14) and 1/4" Flat Washers (#15). Tighten the factory bolts in the Panel assembly from step 8.

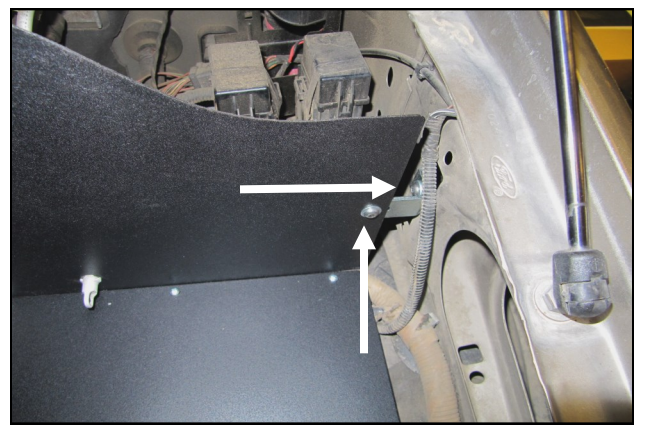

12. Vehicles equipped with a power distribution box mounted on the left inner fender, will remove the bolt from the factory bracket, slide in the bracket 140 (#12) and replace the factory bolt. If you don't have the distribution box, install the provided 1/4-20 button head bolt (#14), washer (#15), and nut (#16), through the inner fender, and tighten. Now tighten the button head bolt that holds the L-bracket to the panel.

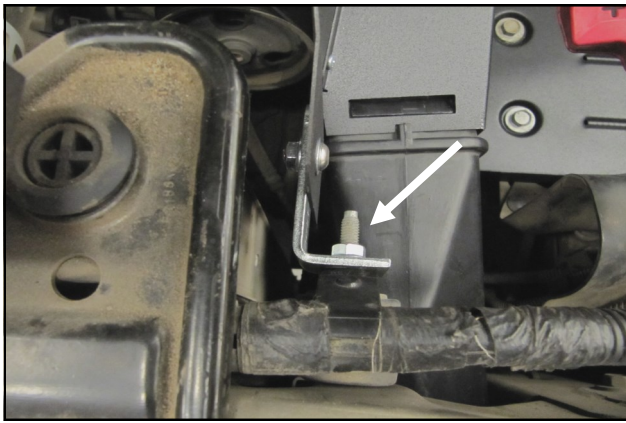

13. Place the second bracket 140 (#12) onto the 6mm core support stud and secure using the 6mm flanged nut (#18). Attach the Bracket to the Panel using one 1/4-20 Button Head Bolt, 1/4" Flat Washer, and 1/4-20 Flange Nut.

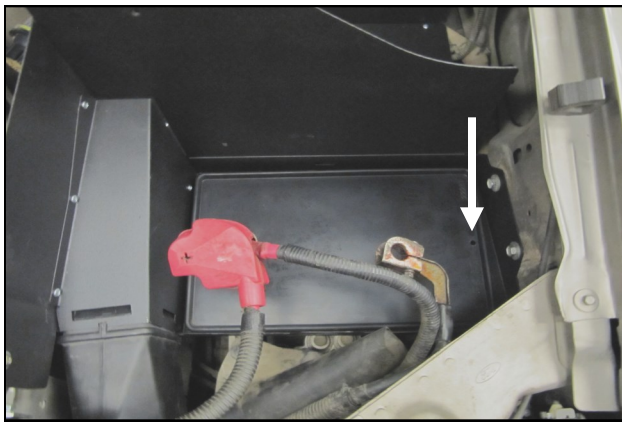

14. Place the Battery Mat (#7) into the CAD assembly with drain tube on the Drivers side.



15. Secure the battery in place using the new 1/4-20 J Bolts(#11), Tie Down (#8) and 1/4-20 Flange nuts. The CAD Panels are slotted to accommodate the J Bolts.



16. Install The Airaid Premium Filter and apply the Airaid Decal as shown.



17. Install the CAD Lid (#6) as shown and secure using four 1/4-20 Button Head Bolts and 1/4" Flat washers. Complete the Installation by attaching the Weather Strip (#9) to the CAD assembly edge surrounding the Filter.



18. **Double check your work!** Make sure there is no foreign material in the intake path. Make sure all clamps, hoses, bolts, and screws are tight. Double check the hood clearance. Reconnect the battery cables.

Thank you for purchasing the Airaid Intake System. Contact Airaid @ (800) 498-6951 8:00 AM - 5:00 PM MST weekdays for questions regarding fit or instructions that are not clear to you. Your Airaid Intake System was carefully inspected and packaged. Check that no parts are missing, or were damaged during shipping. If any parts are missing, contact Airaid. The air filter element is protected from direct exposure to water and debris; care should be taken not to drive through deep water. WATER INGESTION IS THE DRIVERS RESPONSIBILITY! The air filter is reusable and should be cleaned periodically.

FILTER IDENTIFICATION

- 720-472 Airaid Oiled Media
- 722-472 Airaid SynthaMax Dry Media - Black

- 721-472 Airaid SynthaMax Dry Media - Red
- 723-472 Airaid SynthaMax Dry Media - Blue

For your Oiled media filter we suggest using the AIRAID Filter Tune-Up Kit!



P/N 790-551 Aerosol Spray
P/N 790-550 Squeeze Spray



Do Not Oil

Synthamax Air Filters do not require oil. Service air filter as needed by cleaning with common non-petroleum all-purpose household cleaner and water. Simple Green®, Formula 409® or equivalent works great. Apply cleaner to outside of air filter and allow to soak. Then flush filter clean from the inside out with a garden hose and repeat steps if necessary. Do not apply high pressure water or air to clean filter. Allow filter to air dry and reinstall.