



Installation Instructions

For Part Numbers:

450-327 700-495 Airaid Oiled Media Filter

451-327 701-495 SynthaMax Dry Media Filter - Red

452-327 702-495 SynthaMax Dry Media Filter - Black

453-327 703-495 SynthaMax Dry Media Filter - Blue

2015 Ford Mustang

3.7L V6

Component Identification

1	Airaid Premium Filter	1
2	Airaid Intake Tube	1
3	Cold Air Box	1
4	Air Box Window	1
5	Air Box Lid	1
6	Hump Hose	1
7	Reducing Hump Hose	1
8	Filter Adapter	1
9	#48 Hose Clamp	1
10	#64 Hose Clamp	1
11	#68 Hose Clamp	2
12	1/2" ID Grommet	1
13	13/16" ID Grommet	1
14	5/8 Aluminum Fitting	1
15	3/8 Aluminum Fitting	1
16	Button Head Cap Screw	9
17	1/4" Flat Washer	9
18	Airaid Decal	1

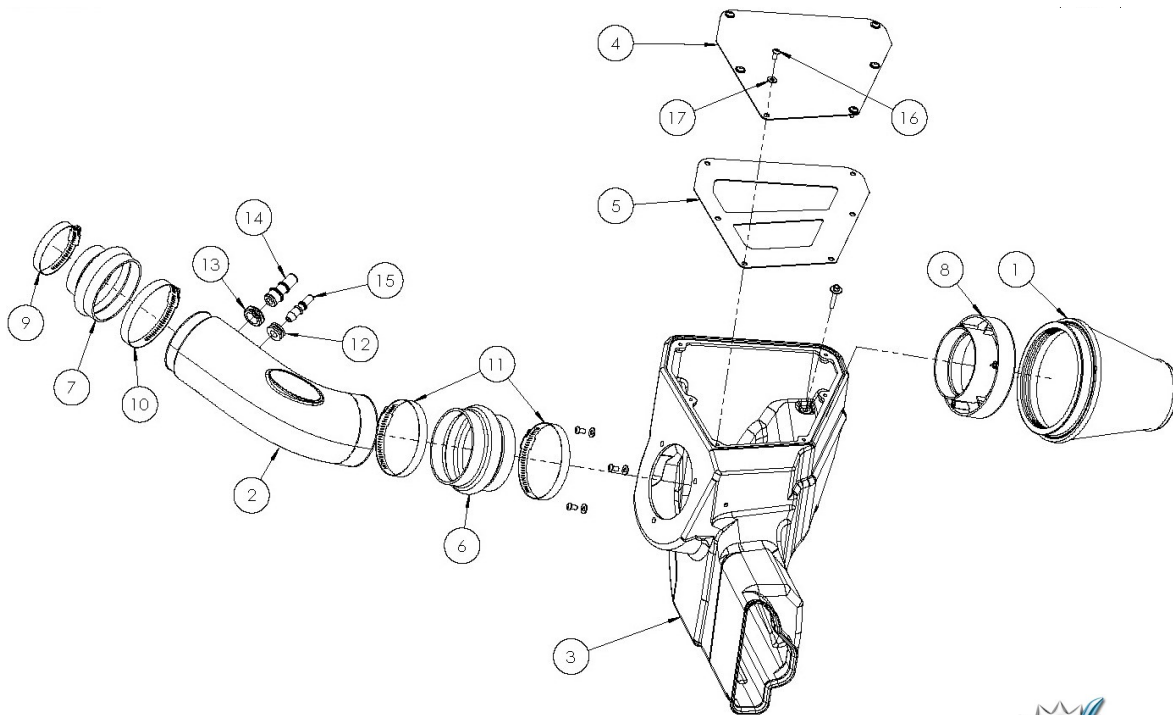

FILTER IDENTIFICATION

700-495 Airaid Oiled Media

702-495 Airaid SynthaMax Dry Media - Black

701-495 Airaid SynthaMax Dry Media - Red

703-495 Airaid SynthaMax Dry Media - Blue

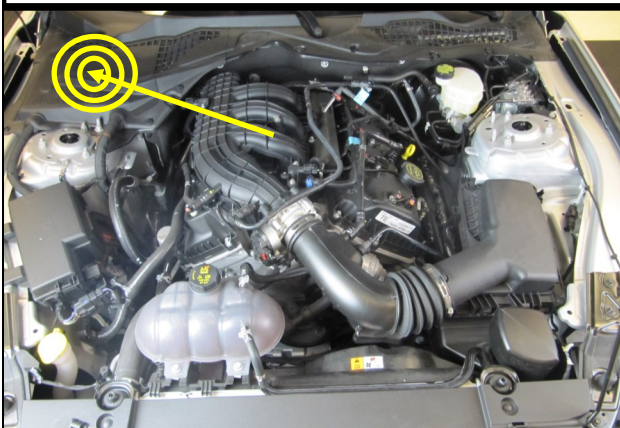

1. Remove the battery box cover in the cowl and disconnect the negative battery terminal.

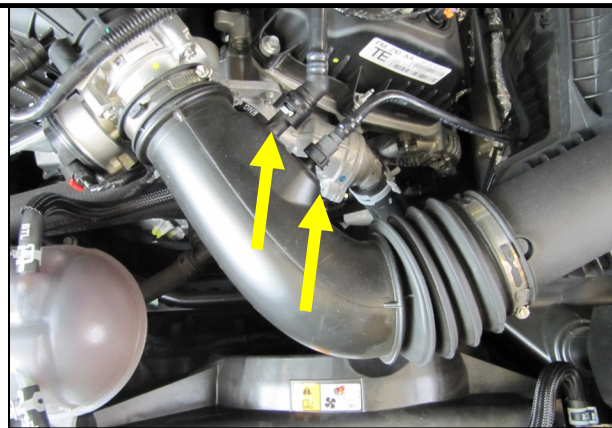

2. Disconnect the 2 breather lines from the intake tube, loosen the hose clamps and remove the factory intake.

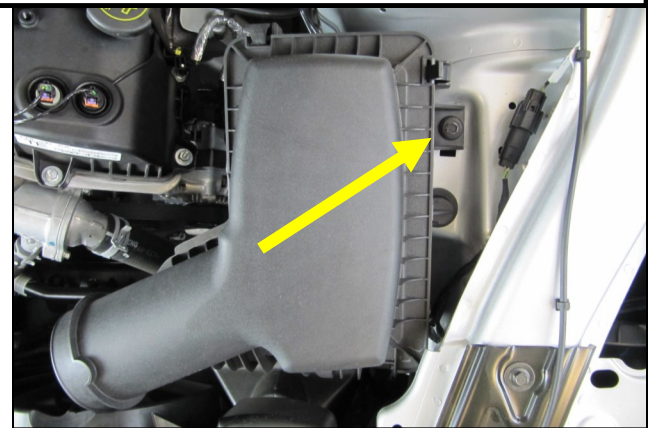

3. Remove the 6mm airbox mounting bolt in the inner fender and lift the entire airbox assembly out of the vehicle. Set the bolt aside for now. It will be reused.

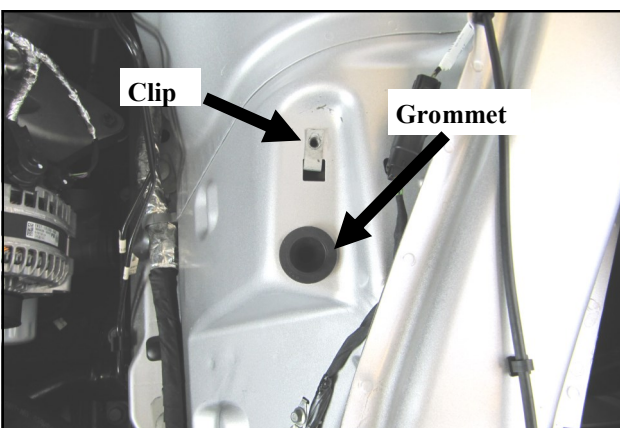

4. Be sure to retain the speed clip in the inner fender, and replace the grommet if it comes out with the air box.



5. Install the Grommets and Aluminum Fittings into the Airaid Intake Tube. Apply the Airaid Decal as shown.

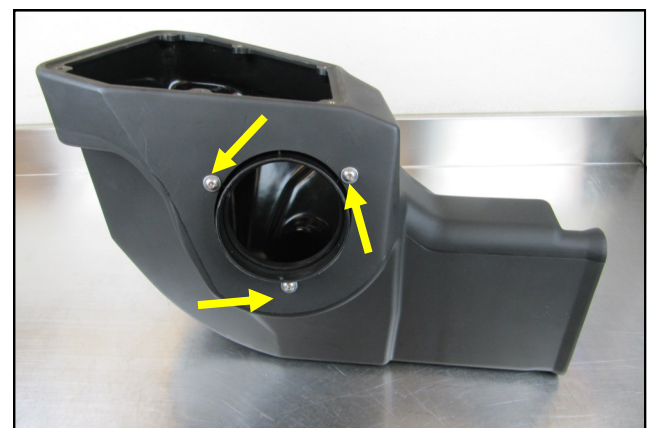

6. Install the Filter Adapter onto the Cold Air Box as shown, using three sets of 1/4-20 Button Head Screws and 1/4" Flat Washers

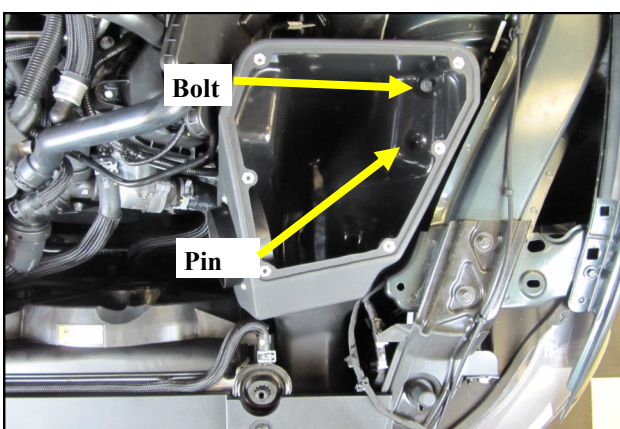

7. Place the Airaid Airbox assembly into the engine compartment as shown, with the locator pin on the bottom of the box inside the fender grommet. Secure the Airbox by reusing the 6mm bolt removed in step # 3.

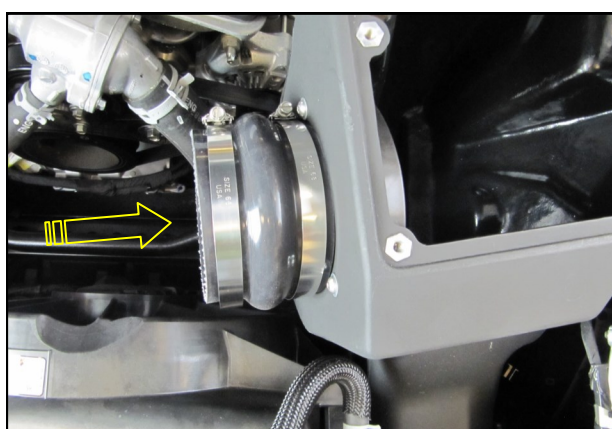

8. Slide the Hump Hose and #68 Clamps onto the Filter Adapter as shown. Do not tighten the clamps at this time.

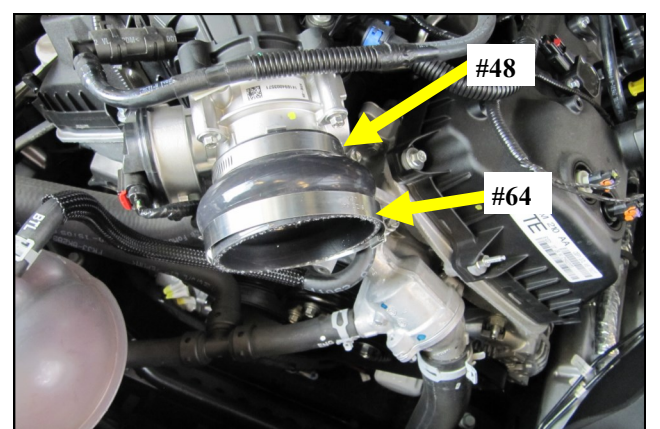

9. Slide the Reducing Hump Hose with the #48 and #64 Clamps onto the Throttle body.

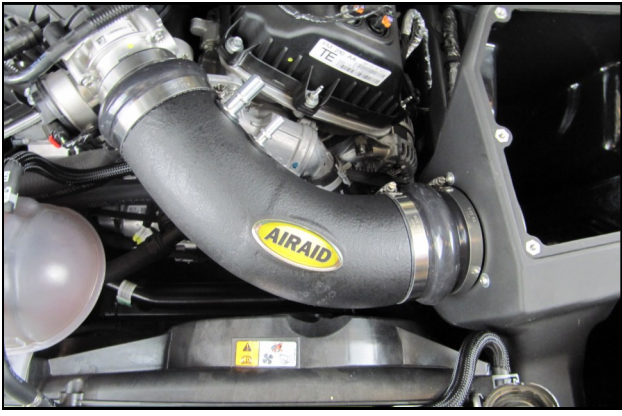

10. Insert the Intake Tube into the Hump Hose and Re-tighten then tighten all 4 Intake Clamps.



11. Reconnect the breather hoses to the Fittings in the Airaid Intake Tube.

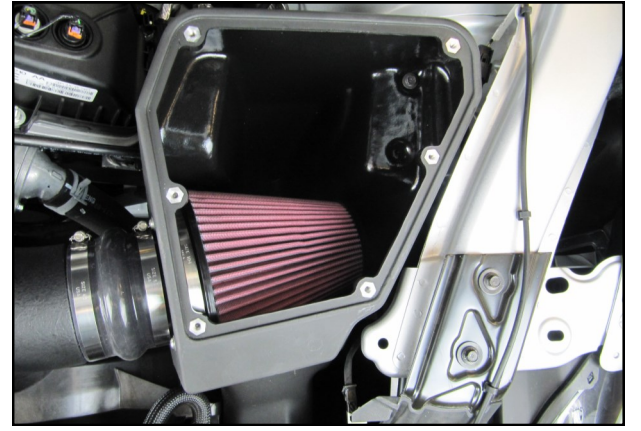

12. Install the Airaid Premium Filter onto the Filter Adapter inside of the Airbox



13. Remove the protective film from the Lid and Window before installation. Install the Airbox lid and Window onto the Airbox, with the Window on top, using 6 sets of 1/4" Button Heads, and Washers.



14. **Double check your work.** Make sure all clamps, hoses, bolts, and screws are tight. Double check the hood clearance. Reconnect the negative battery cable and reinstall the cover.

SynthaMax[®]

Synthamax Air Filters **do not** require oil. Service air filter as needed by cleaning with common non-petroleum all-purpose household cleaner and water. Simple Green[®], Formula 409[®] or equivalent works great. Apply cleaner to outside of air filter and allow to soak. Then flush filter clean from the inside out with a garden hose and repeat steps if necessary. Do not apply high pressure water or air to clean filter. Allow filter to air dry and reinstall.



For your Oiled media filter we suggest using the AIRAID Filter Tune-Up Kit!

Full color instructions can be viewed on our web site at Airaid.com. Use the Product Search function to find your part number, and click View Details.

Thank you for purchasing the Airaid Intake System. Contact Airaid @ (800) 498-6951 8:00 AM - 5:00 PM MST weekdays for questions regarding fit or instructions that are not clear to you. Your Airaid Intake System was carefully inspected and packaged. Check that no parts are missing, or were damaged during shipping. If any parts are missing, contact Airaid. The air filter element is protected from direct exposure to water and debris; care should be taken not to drive through deep water. **WATER INGESTION IS THE DRIVERS RESPONSIBILITY!** The air filter is reusable and should be cleaned periodically.