



Installation Instructions

For Part Numbers:

- 520-188 700-458 Airaid Oiled Media Filter
- 521-188 701-458 Airaid SynthaMax Dry Media Filter - Red
- 522-188 702-458 Airaid SynthaMax Dry Media Filter - Black
- 523-188 703-458 Airaid SynthaMax Dry Media Filter - Blue

2005-17 Nissan Frontier

2005-15 Xterra

2005-12 Nissan Pathfinder

2009-12 Suzuki Equator

4.0L V6

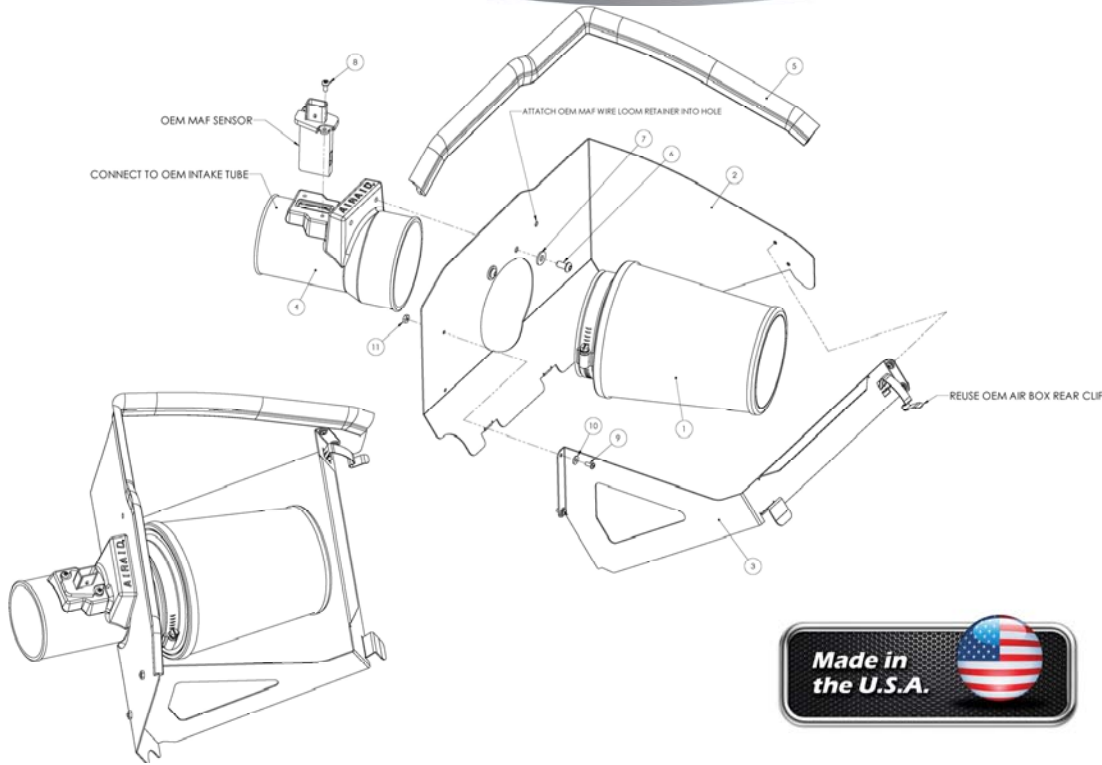

INTAKE SYSTEMS FOR VEHICLES LISTED ARE 50 STATE LEGAL. SEE AIRAID.COM FOR CARB STATUS ON EACH PART FOR A SPECIFIC VEHICLE.

Component Identification

1. AIR-700,701,702,703-458	Airaid Premium Filter	1
2. AIR-KIT188MAFC	MAF Panel	1
3. AIR-KIT152FPC	Front Panel	1
4. AIR-KIT152A	MAF Adapter	1
5. AIR-KITSTRIP52	Weather Strip	1
6. AIR-KIT15DHC3050	1/4"-20 Button Head Bolt	2
7. AIR-KIT09FWZ019	1/4" Flat Washer	2
8. AIR-KIT15BHC3038	8-32x3/8" Button Head Bolt	2
9. AIR-KIT6C31MXPPZ	6-32x5/16" Screw	4
10. AIR-KIT6NWSAPZ	#6 Flat Washer	4
11. AIR-KIT6CNKEPZ	6-32 Keps Nut	4
12. AIR-KITSTICKER12	Airaid Foil Decal	1

Full color instructions can be viewed on our web site at Airaid.com. If you need any assistance please call 1-800-858-3333 to speak with a representative in our Customer Service Center before returning the product.

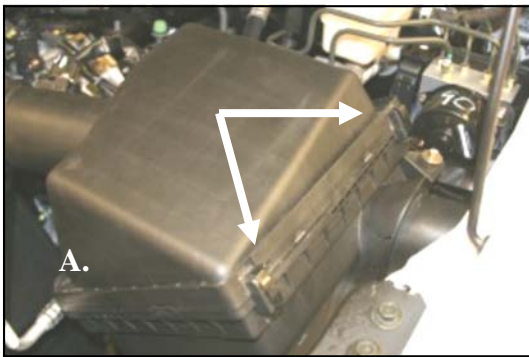

1. **Disconnect negative battery cable.** Unhook two latches on the factory airbox.



2. Loosen the hose clamp on factory airbox neck.



3. Using pliers, carefully squeeze the two tabs together, and remove the wire loom retainer from the factory airbox lid.

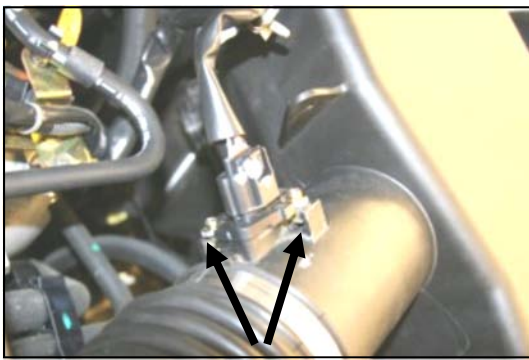

4. Remove the two screws that hold the Mass Air Flow sensor.



5. **Without** disconnecting the MAF sensor, remove it from the factory airbox lid, and set it aside. **It is important** to note the direction of the MAF sensor when removed, as to assure correct reinstallation later in the install process. **The MAF sensor must be installed in the correct direction for proper air flow calibration.**



6. Remove the factory airbox lid.



7. Remove the factory air filter.



8. Very carefully remove the rear clip from the factory airbox.



9. Assemble the Quick Fit Panels (#2&3) as shown, using the four supplied screws (#9), washers (#10), and nuts (#11). Apply the Airaid Foil Decal onto the Panel as shown.

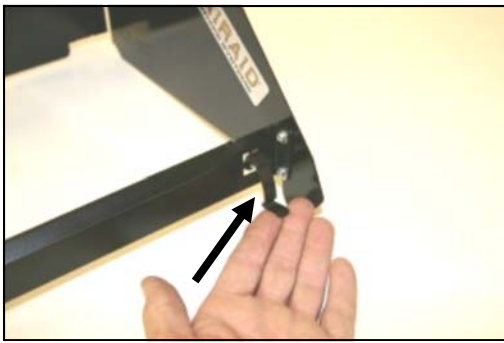

10. Reinstall the factory clip that was removed in step #8 onto the front panel of the Quick Fit Panel as shown.

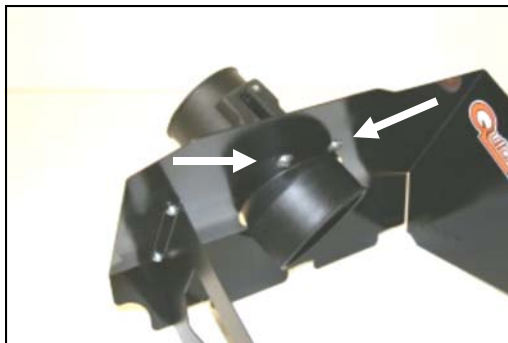

11. Install the MAF adapter (#4) into the Quick Fit Panel using two 1/4"x20 button head bolts (#6) and washers (#7).

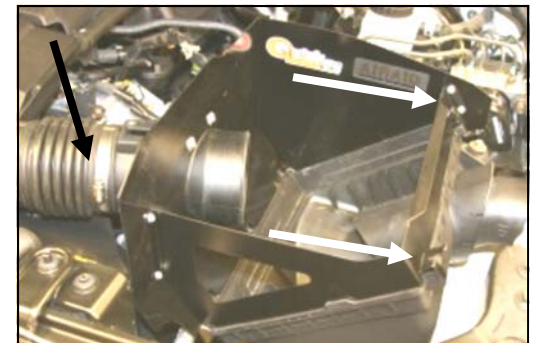

12. Install the MAF adapter into the factory intake tube, and at the same time slide the three tabs on the back of the Quick Fit Panel into the three slots on the factory airbox base. Adjust for fit, then snap the two factory clips to secure the panel. Next tighten the hose clamp where the factory tube slides over the MAF adapter.

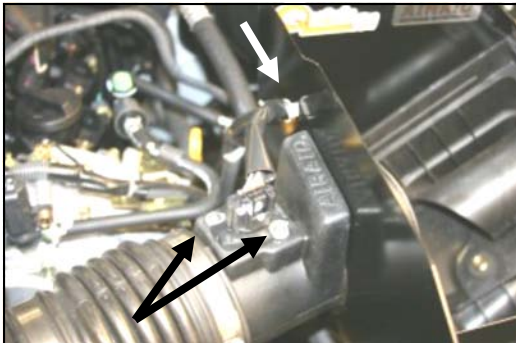

13. Install the MAF sensor from step #5 into the MAF adapter. Use the two supplied button head bolts (#8), to securely fasten the MAF. **Do Not Use The Factory Screws!** Next push and snap the wire loom retainer from Step #3 into the hole in the MAF panel.



14. Install the Airaid Premium Filter (#1) on the MAF adapter and tighten the clamp. Next install the weather strip (#5) on top of the Quick Fit Panel as shown. For an easier install, start at the front of the Quick Fit Panel and work your way towards the back.

15. Double check your work!

Make sure there is no foreign material in the intake path. Make sure all clamps, hoses, bolts, and screws are tight.

16. Reconnect the negative battery cable!

Thank you for purchasing the Airaid Intake System. Contact Airaid @ (800) 498-6951 8:00 AM - 5:00 PM MST weekdays for questions regarding fit or instructions that are not clear to you. Your Airaid Intake System was carefully inspected and packaged. Check that no parts are missing, or were damaged during shipping. If any parts are missing, contact Airaid. The air filter element is protected from direct exposure to water and debris; care should be taken not to drive through deep water. WATER INGESTION IS THE DRIVERS RESPONSIBILITY! The air filter is reusable and should be cleaned periodically.

FILTER IDENTIFICATION

700-458 Airaid Oiled Media
702-458 Airaid SynthaMax Dry Media - Black

701-458 Airaid SynthaMax Dry Media - Red
703-458 Airaid SynthaMax Dry Media - Blue

For your oiled media filters we suggest the AIRAID Filter Tune-Up Kit!

SynthaMax[®]

Do Not Oil



P/N 790-551 Aerosol Spray
P/N 790-550 Squeeze Spray



Synthamax Air Filters do not require oil. Service air filter as needed by cleaning with common non-petroleum all-purpose household cleaner and water. Simple Green[®], Formula 409[®] or equivalent works great. Apply cleaner to outside of air filter and allow to soak. Then flush filter clean from the inside out with a garden hose and repeat steps if necessary. Do not apply high pressure water or air to clean filter. Allow filter to air dry and reinstall.

INTAKE SYSTEMS FOR VEHICLES LISTED ARE 50 STATE LEGAL. SEE AIRAID.COM FOR CARB STATUS ON EACH PART FOR A SPECIFIC VEHICLE.