



Installation Instructions

For Part Number:

883-305 Snorkel Kit

2011-14 Polaris Ranger

XP 800



Tools Required For Installation:

7/16" and 1/2" Wrenches. 10mm, 7/16", and 1/2" Sockets. Utility knife
 T-25 Torx driver and 5/32" Allen Wrench.
 Ratchet & Extension. 1/8" & 5/16" Drill bits.
 Dremel® Rotary Tool
 Center punch and Mallet Utility Knife
 Phillips and Standard Tip Screwdrivers.
 90deg. Low Profile Ratcheting Screwdriver
 Loctite® 242 or equivalent, and a roll of masking tape

Thank you for purchasing the Airaid Intake System. Contact Airaid @ (800) 498-6951 8:00 AM - 5:00 PM MST weekdays for questions regarding fit or instructions that are not clear to you. Your Airaid Intake System was carefully inspected and packaged. Check that no parts are missing, or were damaged during shipping. If any parts are missing, contact Airaid. The air filter element is protected from direct exposure to water and debris; care should be taken not to drive through deep water. WATER INGESTION IS THE DRIVERS RESPONSIBILITY! The air filter is reusable and should be cleaned periodically.

Full color instructions can be viewed on our web site at Airaid.com. Use the **Product Search** function to find your part number, and click **View Details**.

Advisory Note:

Please read these installation instructions in their entirety before beginning the install process. Airaid strongly recommends the use of Loctite® 242 Medium strength threadlocker on all threaded fasteners.



1. Lift the hood, secure it in the upright position, and disconnect the battery or batteries.



2. In the passenger side firewall area, locate the foam prefilter box and Loosen the hose clamp. Remove the prefilter box and set it aside.



3. Mount the Snorkel Inlet to the Snorkel Tube (#2), using the four Torx screws (#14) and a 90deg. Low Profile Ratcheting Screwdriver.



4. Carefully insert the Airaid Foam Prefilter (#7) into the Snorkel Inlet.



5. Install the Snorkel Screen (#4) onto the Inlet using the four 8-32 Button Head Screws(15).



6. Preinstall the three Loop Clamps (#10) onto the right front A pillar of the cage.

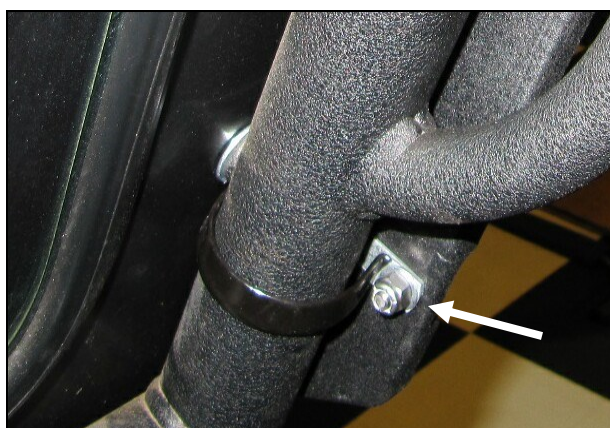

7. Attach the Snorkel Tube to the Loop Clamps using three 1/4-20 Button Head Bolts (#11), 1/4-20 Locknuts (#12), and Flat washers (#13). Leave all hardware finger tight at this time to allow for proper alignment .



8. Outside view of properly placed Snorkel and clamps.



9. Place a shop towel inside of the factory inlet hose to prevent debris from entering.



10. Prepare the right front fender for cutting by covering the entire area with masking tape. Cut out the Template and align all four edges against the radius of the fender. Tape down the template and mark the bolt holes with a center punch.

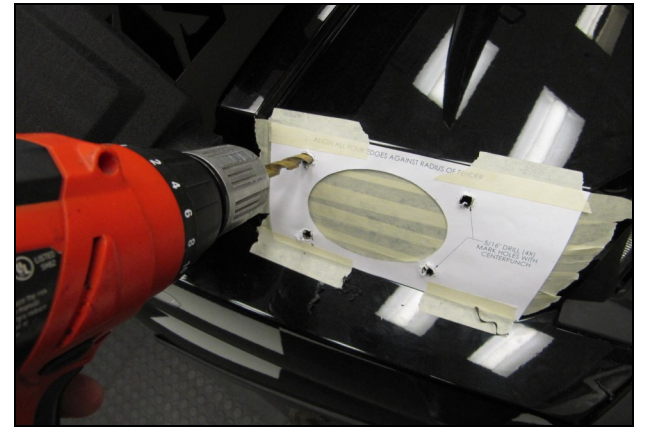

11. Drill out the bolt holes starting with a 1/8" pilot hole and finishing with a 5/16" bit.

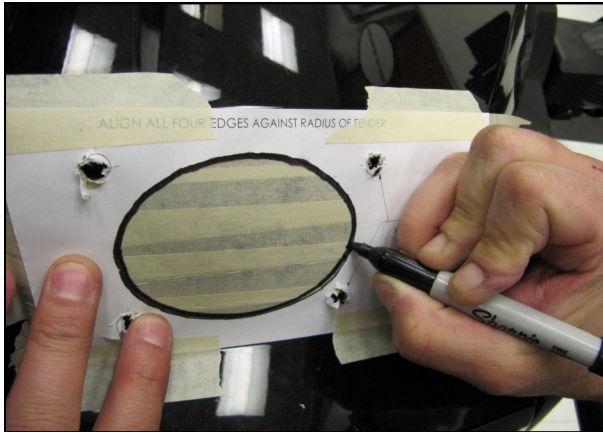

12. Trace the center oval onto the masking tape with a marker.



13. Using a Dremel type rotary tool and a 1/8" drill bit, plunge into the inner oval at medium speed and cut along the line until the center falls out. Remove the tape.

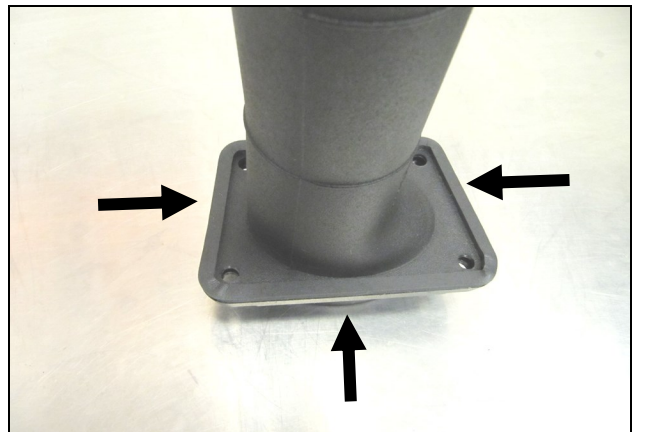

14. Prepare the fender Adapter (#5) for installation by wiping the mating surface down with a prep-sol or brake clean and attaching the weatherstrip (#8). As shown.

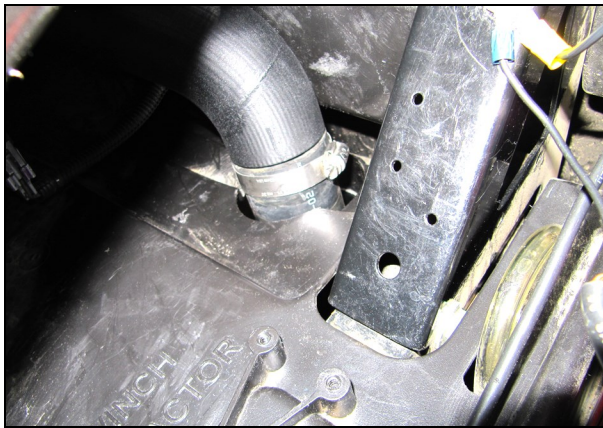

15. Remove the shop towel and insert the Fender Adapter into the fender hole and connect it to the factory air inlet. Do not tighten the hose clamp at this time.

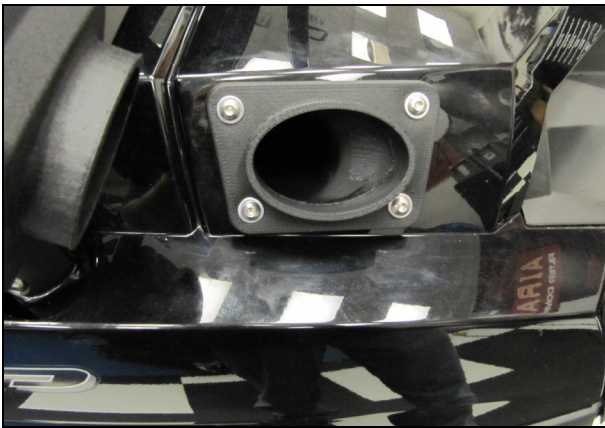

16. Mount the Adapter to the fender using Four 1/4-20 Button Head Bolts (#11), eight 1/4" Flat Washers (#13), and four 1/4-20 Locknuts (#12). Tighten the factory air inlet hose clamp.



17. To accommodate many cage variations, this kit is supplied with an oversized Tube to Adapter coupler (#6). Determine the required trim lengths for your particular application and mark the coupler with a permanent marker.



18. Once you have your coupler length marked, slide a hose clamp (#9) onto the coupler and tighten the clamp along the mark. Use the hose clamp as a guide to trim the coupler to length with a sharp utility knife.

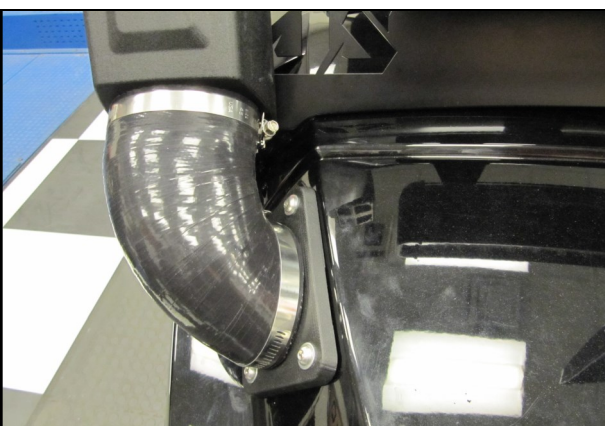

19. Install the trimmed Coupler with clamps (#9) onto the Snorkel tube and the Fender adapter. Tighten the Hose clamps and the three Snorkel Tube Clamps on the cage.

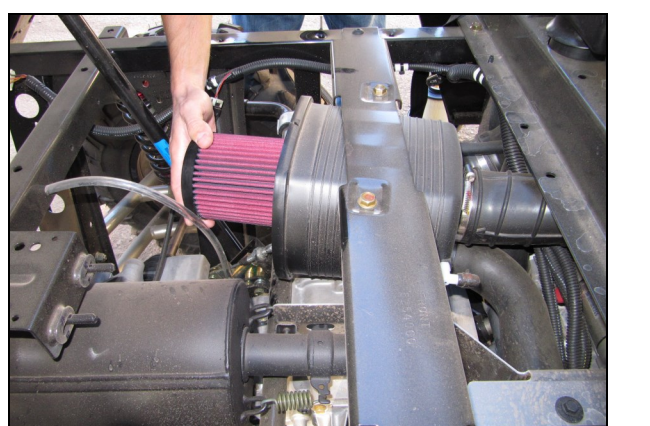

20. Tilt the bed back and install the Airaid Premium filter (#1).



21. Reconnect the battery or batteries.



22. **Double check your work!** Make sure there is no foreign material in the intake path. Make sure all clamps, hoses, bolts, and screws are tight. Make sure all clamps, hoses, bolts, and screws are tight. Periodically check the tightness of all hose clamps.



For your Oiled media filter we suggest using the AIRAID Filter Tune-Up Kit!



P/N 790-551 Aerosol Spray
P/N 790-550 Squeeze Spray

REV.12.03.15

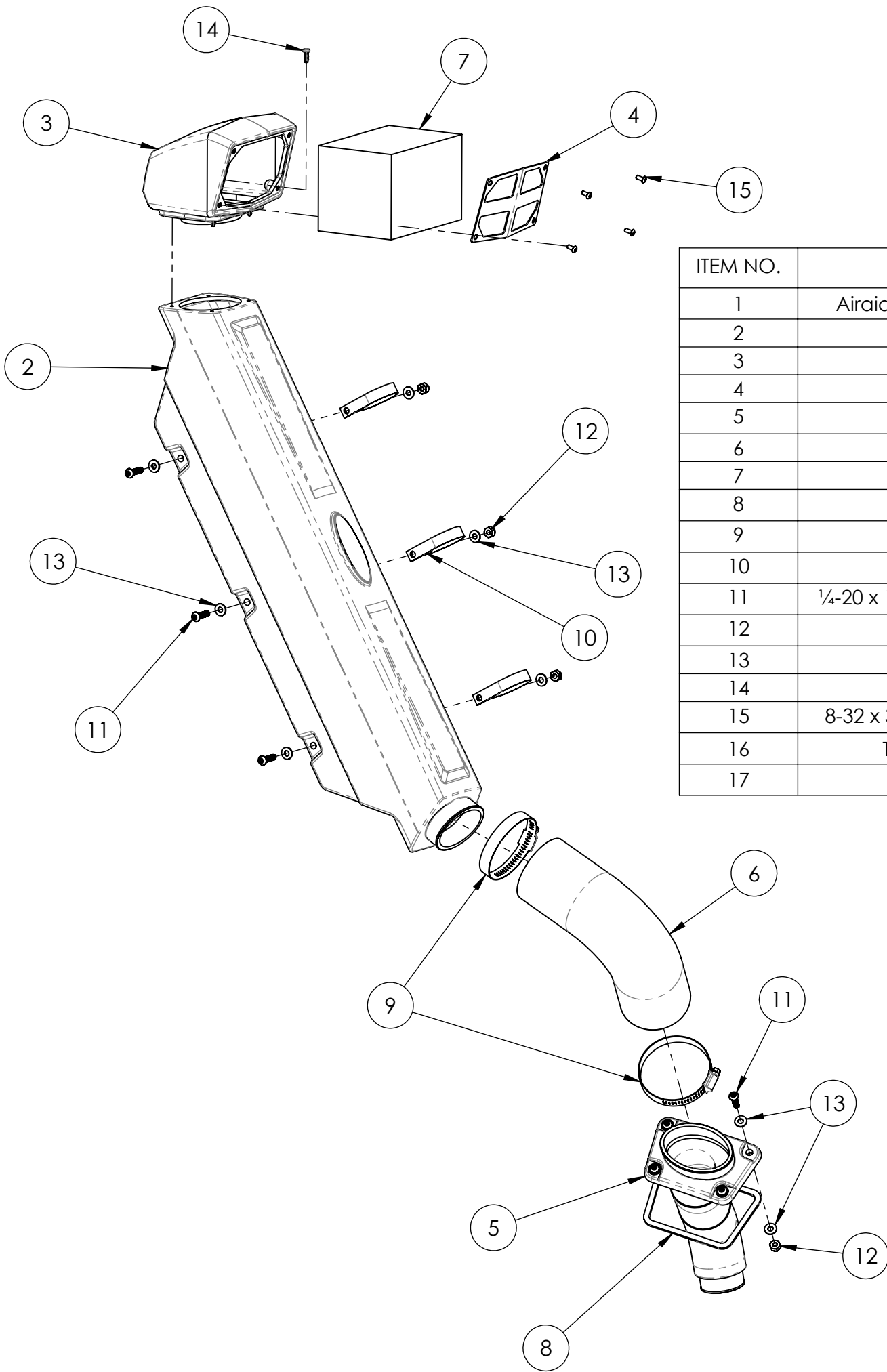

ITEM NO.	Description	QTY.
1	Airaid Premium Filter (Not Shown)	1
2	Snorkel Tube	1
3	Snorkel Inlet	1
4	Snorkel Screen	1
5	Fender Adapter	1
6	Silicone Elbow	1
7	Foam Prefilter	1
8	Adhesive Weatherstrip	1
9	#48 Hose Clamp	2
10	1 3/4" Loop Clamp	3
11	1/4-20 x 1.00" Button Head Cap Screw	7
12	1/4" Nylon Lock Nut	7
13	1/4" Flat Washer	14
14	Torx Plastic Screw	4
15	8-32 x 3/8" Button Head Cap Screw	4
16	Torx T20 Bit (Not Shown)	1
17	Bubble Sticker	1

