



Installation Instructions

For Part Number:

883-311 Snorkel kit for Airaid PN

883-306

Component Identification

1.	Airbox Lid	1
2.	Snorkel Tube	1
3.	Snorkel Inlet	1
4.	Snorkel Screen	1
5.	Foam Prefilter	1
6.	3" Flexible Duct, 40"	1
7.	3" Loop Clamp	2
8.	1/4-20 x 1/2" Button Head Bolt	2
9.	1/4-20 Speed Nut	2
10.	1 3/4" Loop Clamp	3
11.	1/4-20x 1 1/4" Bolt	3
12.	1/4" Flat Washer	6
13.	1/4-20 Nylock Nut	3
14.	8-32 x 3/8 Button Head Bolt	4
15.	Torx Screw	4
16.	# 48 Hose Clamp	1
17.	Edge Trim, 10"	1
18.	Torx Bit #20	1
19.	Bubble Sticker	1

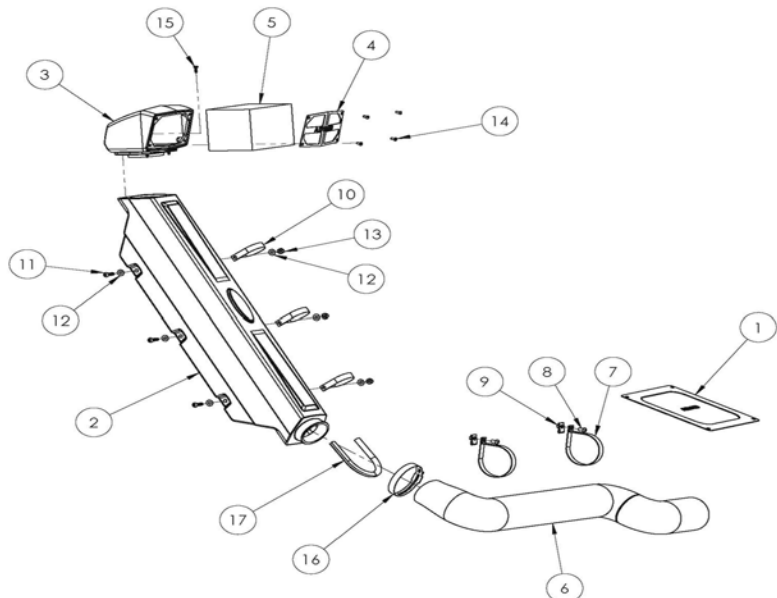

NOT LEGAL FOR SALE OR USE ON ANY POLLUTION CONTROLLED MOTOR VEHICLE IN CALIFORNIA OR STATES ADOPTING CALIFORNIA EMISSION

See AIRAID.COM for CARB status on each part for a specific

Tools Required For Installation:

In addition to common hand tools, installation of this kit requires the use of a Jig Saw or equivalent. Low Profile Ratcheting Screwdriver.

Full color instructions can be viewed on our web site at Airaid.com.



1. Disconnect the negative battery terminal. Install the Airbox Lid (#1) onto the Airaid performance Airbox using The four 1/4-20 x 1/2" Button Heads Bolts and 1/4" Flat Washers from the Airaid 883-306 intake.



2. Side the three small Loop Clamps (#10) onto the roll cage A pillar as shown.



3. Mount the Snorkel Inlet(#3) to the Snorkel Tube (#2), using the four Torx screws (#16), Torx Bit #18 and a 90deg. Low Profile Ratcheting Screwdriver.



4. Carefully insert the Airaid Foam Prefilter (#5) into the Snorkel Inlet.



5. Install the Snorkel Screen (#4) onto the Inlet using the four 8-32 Button Head Screws(#15).



6. Attach the Snorkel Tube to the Loop Clamps using three 1/4-20 x 1 1/4 Bolts (#12), 1/4-20 Locknuts (#14), and Flat washers (#13). Leave all hardware finger tight at this time to allow for proper alignment

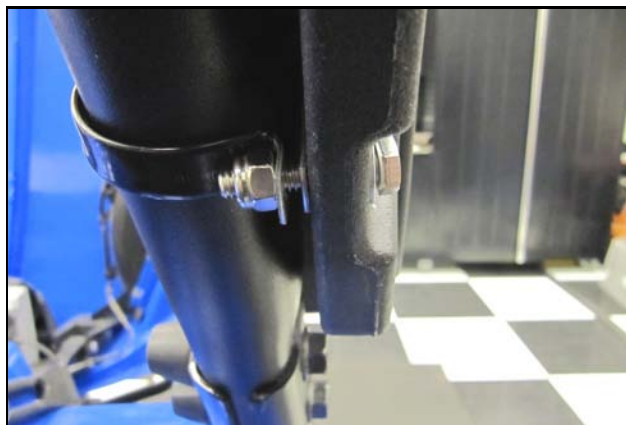

7. Close up of proper Snorkel hardware orientation.



8. Remove the Urethane Cap from the Airaid performance Airbox. The Clamp will be reused in step #10, the cap will not be reused.

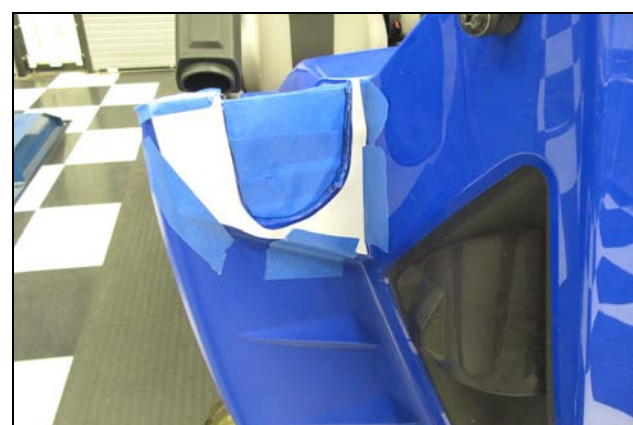

9. Install Cut out the fender Template and tape it in position on the corner of the passenger side hood as shown.



7. Using a jig saw or equivalent, follow the template and cut out the Duct relief.

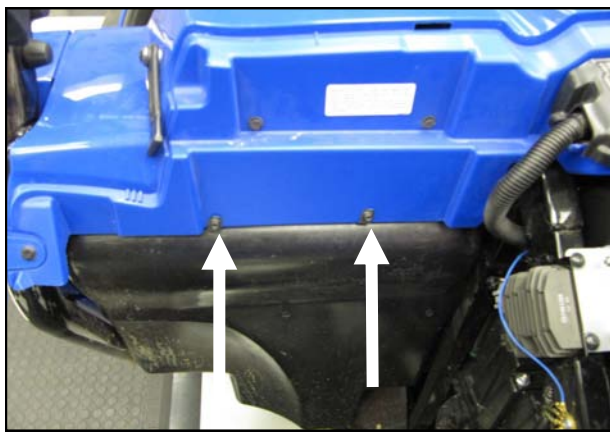

8. Install Slide the Speed Nuts (#11) onto the Cowl plastic with the threaded side out.



9. Using a pair of dykes, pull out approximately three windings of the steel wire inside of the Ducting (#6) and cut it off.



10. Install the Flexible Duct onto the Airaid performance airbox as shown. Re use the Clamp from step # 5.



11. Install the other end of the Ducting onto the Snorkel tube using the #48 Hose Clamp (#16).



12. Full view of Duct routing. Duct is provided with an additional 8" in length and may be trimmed if desired.

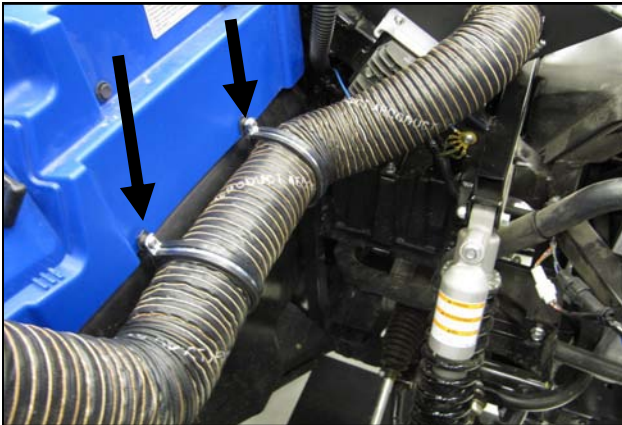

13. Mount the duct to the Speed Nuts on the bulkhead using the two 3" Loop Clamps and 1/4-20 x 1/2" button Head Bolts (#8).



14. Slide the Edge Trim (#17) over the cut out on the Hood.



15. Align the Snorkel and Ducting and verify the opening and closing action of the hood is not adversely effected. Tighten all of the Clamp bolts when done.



16. Double check all of your work and re connect the battery.

Thank you for purchasing the Airaid Intake System. Contact Airaid @ (800) 498-6951 8:00 AM - 5:00 PM MST weekdays for questions regarding fit or instructions that are not clear to you. Your Airaid Intake System was carefully inspected and packaged. Check that no parts are missing, or were damaged during shipping. If any parts are missing, contact Airaid. The air filter element is protected from direct exposure to water and debris; care should be taken not to drive through deep water. WATER INGESTION IS THE DRIVERS RESPONSIBILITY! The air filter is reusable and should be cleaned periodically.

For your Oiled media filter we suggest using the AIRAID Filter Tune-Up Kit!



**P/N 790-551 Aerosol Spray
P/N 790-550 Squeeze Spray**



NOT LEGAL FOR SALE OR USE ON ANY POLLUTION CONTROLLED MOTOR VEHICLE IN CALIFORNIA OR STATES ADOPTING CALIFORNIA EMISSION PROCEDURES.
See AIRAID.COM for CARB status on each part for a specific vehicle.

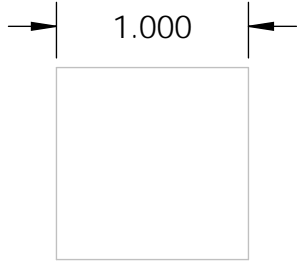
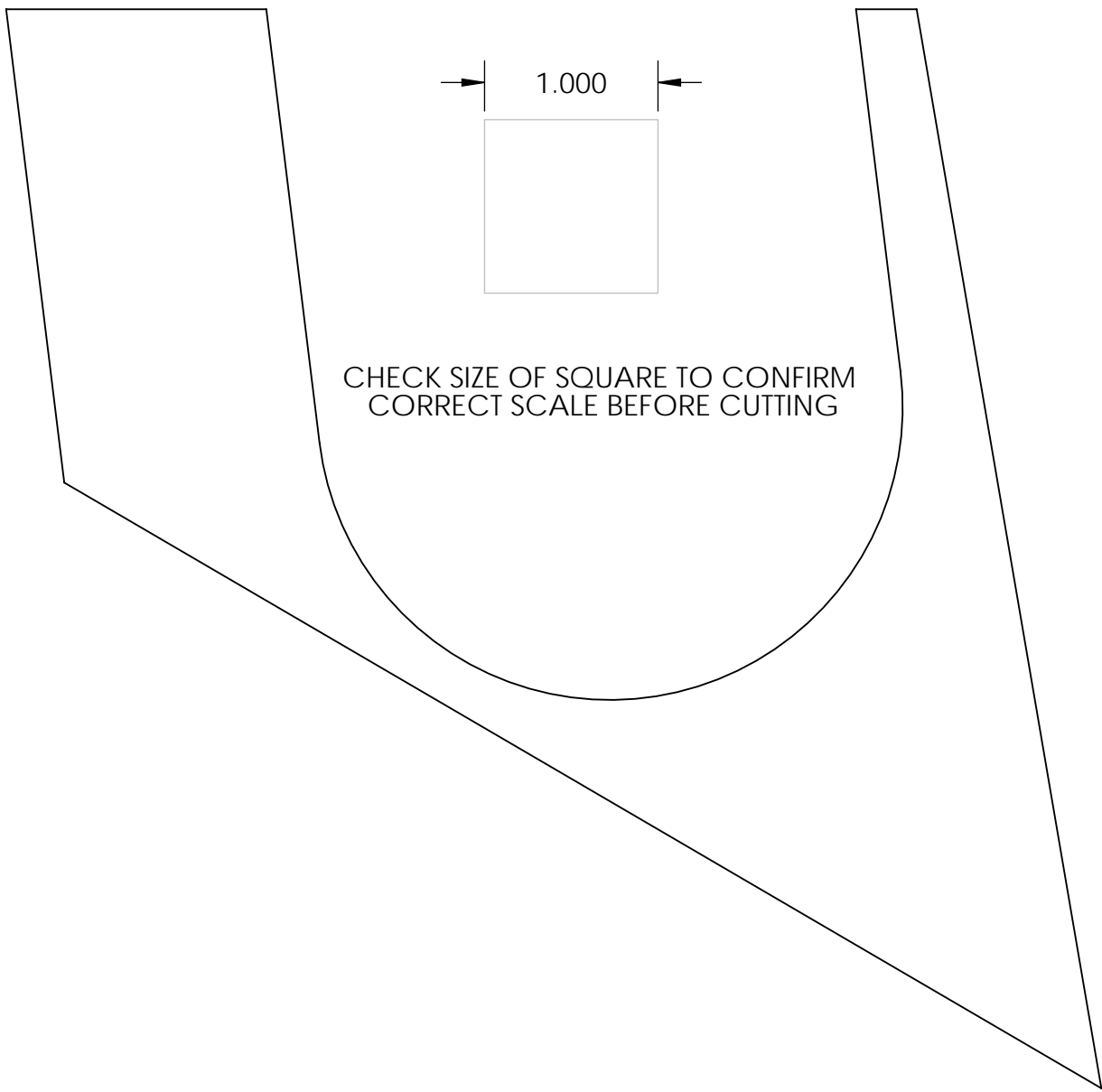

CHECK SIZE OF SQUARE TO CONFIRM
CORRECT SCALE BEFORE CUTTING