

INSTALLATION INSTRUCTIONS

BULL BAR PART# B35-5005 / 35-5005

2009-10 DODGE RAM 1500

PARTS LIST:

Qty	Description	Qty	Description
1	Bull Bar	10	12mm Lock Washers
2	Upper Frame Mounting Brackets (for trucks without tow hooks only)	8	12-1.75mm Hex Nuts
1	Driver/Left Lower Frame Mounting Bracket	2	10-1.5mm x 35mm Hex Bolts
1	Passenger/Right Lower Frame Mounting Bracket	2	10mm Lock Washers
1	Driver/Left Support Bracket	4	10mm x 30mm OD x 3mm Flat Washers
1	Passenger/Right Support Bracket	2	10-1.5mm Hex Nuts
2	12-1.25mm x 25mm Fine Thread Hex Bolt (for trucks without tow hooks only)	2	6mm x 20mm Button Head Allen Bolt S/S
4	12-1.75mm x 35mm Hex Bolts	4	6mm x 12mm OD x 1.4mm Flat Washers S/S
14	12mm x 30.1mm OD x 3.1mm Flat Washers	2	6mm Nylock Hex Nut S/S

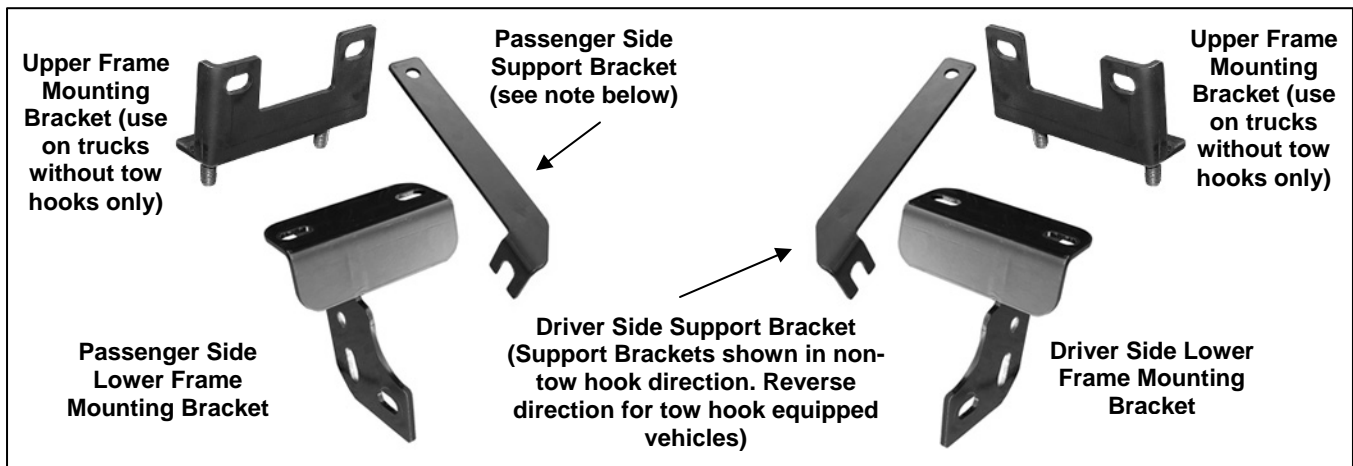

PROCEDURE:

- 1. REMOVE CONTENTS FROM BOX. VERIFY ALL PARTS ARE PRESENT. READ INSTRUCTIONS CAREFULLY BEFORE STARTING INSTALLATION. CUTTING IS REQUIRED. ASSISTANCE IS RECOMMENDED.**
- Starting at the underside of the front bumper, carefully remove the plastic splash guard. **NOTE:** Depending on the model of truck, the splash guard may be attached to the bottom of the truck with hex bolts. There are also several two-piece plastic push-in clips across the back, behind the bumper cover holding the splash guard up to the cover, (**Figure 1A**). First, locate the clips behind the bumper cover. Pry the center pin of the clip up with a small flat blade screwdriver and remove the entire clip, (**Figure 1B**). The splash guard may also be attached with rivets or hex bolts at the corners of the bumper cover. If the guard is fastened with rivets, once all of the other hardware has been removed, hold the bumper cover in place and firmly pull the splash guard from the rivet. Remove the rivet from the bumper cover and move the splash guard to a clean stable work area. Pay close attention to the type and location of all factory hardware for reinstallation.
- From underneath the front of the vehicle, determine if the truck is equipped with or without tow hooks.

For models without tow hooks:

A. Select one of the Upper Frame Brackets and the driver side Lower Frame Mounting Bracket. Bolt the two together with (2) 12mm Flat Washers, (2) 12mm Lock Washers and (2) 12mm Hex Nuts. **NOTE:** On some vehicles, it may be easier to assemble the two-piece bracket on the vehicle, **(Figure 3)**. Snug the hardware but do not tighten at this time.

B. Remove the hex nuts on the two lower factory bumper bolts, **(Figure 2A)**. Insert the assembled Mounting Bracket up from behind the bumper and align the holes in the Mounting Bracket with the bumper bolts. Attach the Bracket to the bumper bolts using the factory hex nuts and tighten this hardware only.

For models with tow hooks:

A. Remove the (2) hex nuts holding the front of the tow hook to the back of the bumper. Select the driver side Lower Mounting Bracket and hang it from the tow hook mounting studs, **(Figure 2B)**. Attach the Lower Mounting Bracket to the two studs using the factory Hex Nuts. Snug the hardware but do not tighten at this time.

4. Repeat step 3 for the passenger side bracket installation.
5. With help, position the Bull Bar on the inside of the Mounting Brackets. Use the included (4) 12-1.75mm x 35mm Hex Head Bolts, (4) 12mm Lock Washers, (8) 12mm Flat Washers, and (4) 12-1.75mm Hex Nuts to attach the Bull Bar to the Mounting Brackets, **(Figure 3)**. Snug but do not tighten hardware.
6. Stand back from the vehicle and check to see that the Bull Bar is centered and level on the vehicle and adjust as necessary. Tighten only the hardware securing the Mounting Brackets to the truck. Do not tighten the hardware on the Bull Bar. Remove the Bull Bar.
7. Hold the splash guard up to the bumper cover and align it with the mounting points. Mark the location of the Mounting Brackets onto the back of the splash guard, **(Figure 4)**. Measure the Brackets and the location of the mounting points before cutting to double check the location marked to cut, **(Figure 5)**. Cut an approximately 1/2" wide by 4" long slot in the splash guard as pictured in **Figure 6**. **NOTE:** The size of the slot is an estimate only and may vary due to different factory designs of splash guards and front bumper covers. Also, additional cutting may be required to clear the Support Bracket on vehicles equipped with tow hooks. Hold the Support Bracket in location to check for clearance and cut as required. **IMPORTANT:** To maintain the integrity of the splash guard, do not cut the slot any larger than necessary. It is recommended to make several small cuts and check the fit often for a clean installation.
8. Once the final cuts have been made, reinstall the splash guard using the factory hardware. Use the included (2) 6mm x 20mm Allen Bolts, (4) 6mm Flat Washers and (2) 6mm Hex Nuts to replace the rivets if required, **(Figure 7)**.
9. Install the Support Brackets.

A. For vehicles without tow hooks. Install the driver side Support Bracket with the slotted side toward the front of the truck. Bolt the Bracket to the inside of the Lower Mount using the round hole above the two slotted holes in the Bracket. Use the included (1) 10mm x 35mm Hex Bolt, (2) 10mm Flat Washers, (1) 10mm Lock Washer and (1) 10mm Hex Nut, **(Figure 8A)**. Attach the rear of the Support Bracket to the frame with (1) 12-1.25mm x 25mm Fine Thread Hex Bolt, (1) 12mm Flat Washer and (1) 12mm Lock Washer. **IMPORTANT:** The hole in the bottom of the frame is fine thread. Only use the 12-1.25mm x 25mm Hex Bolt provided in the hardware kit. Repeat this step for the passenger side Support Bracket. Snug but do not tighten all hardware at this time.

B. For vehicles with tow hooks. Install the driver side Support Bracket with the round hole toward the front of the truck and the slotted hole to the rear. Bolt the slotted end of the Support Bracket to the rear mounting bolt for the tow hook. Loosen the factory hex bolt and insert the slotted end of the Support Bracket under the head of the factory bolt, **(Figure 8B)**.

Do not bolt the front of the Support Bracket to the inside of the Lower Mounting Bracket at this time. Repeat this step for the passenger side Support Bracket. Snug but do not tighten all hardware at this time.

10. Reinstall the Bull Bar described in Step # 5, **(Figure 9)**. **NOTE: For models with tow hooks-** Attach the front of the Support Bracket to the rear oval hole in the Lower Mounting Bracket for the Bull Bar using the same 12mm x 35mm Hex Bolts securing the Bull Bar.
 11. Level and adjust the Bull Bar and tighten all hardware.
 12. Do periodic inspections to the installation to make sure that all hardware is secure and tight.
- To protect your investment**, wax this product after installing. Regular waxing is recommended to add a protective layer over the finish. Do not use any type of polish or wax that may contain abrasives that could damage the finish.
- For stainless steel:** Aluminum polish may be used to polish small scratches and scuffs on the finish. Mild soap may be used also to clean the Bull Bar.
- For gloss black finishes:** Mild soap may be used to clean the Bull Bar.

Driver Side Installation Pictured

Pry up the center pin on the clip to remove the complete fastener. If the center pin comes out, remove the housing then push the pin back into the housing as per Fig 1B to reinstall.

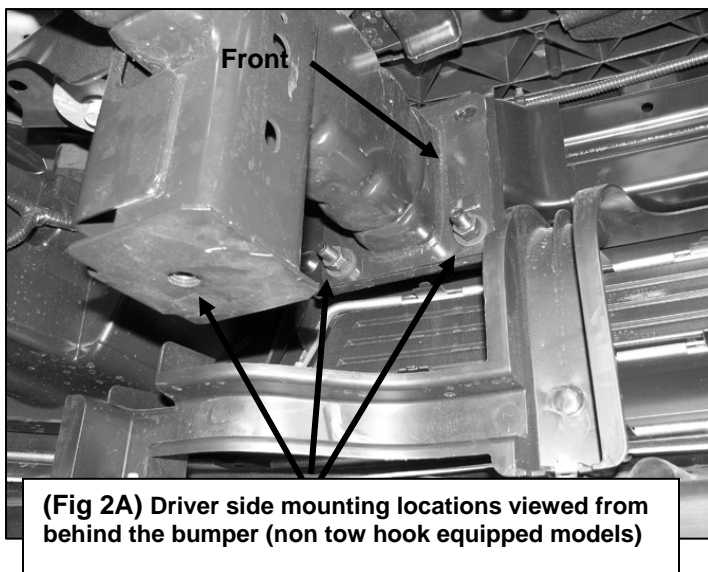
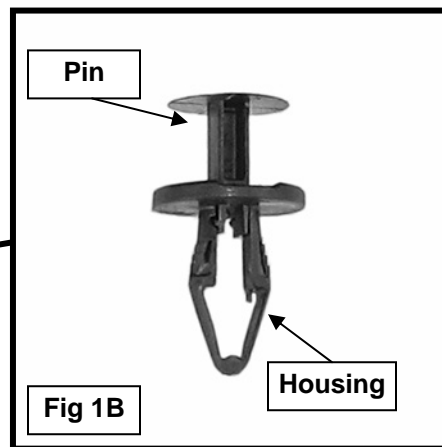
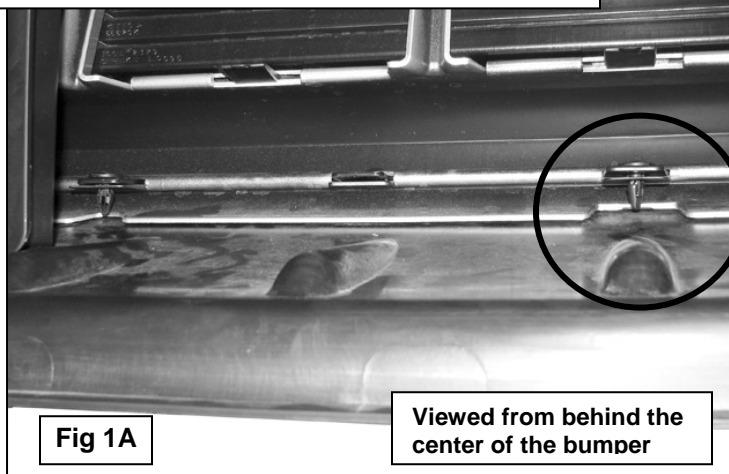

Driver Side Installation Pictured

IMPORTANT: On trucks without tow hooks, use only the supplied
12-1.25mm x 25mm Fine Thread Hex Bolt
12mm Flat Washer
12mm Lock Washer

Upper Frame Mounting
Bracket installation

Installation pictured
without the splash
guard for illustration

Lower Frame Mounting
Bracket installation

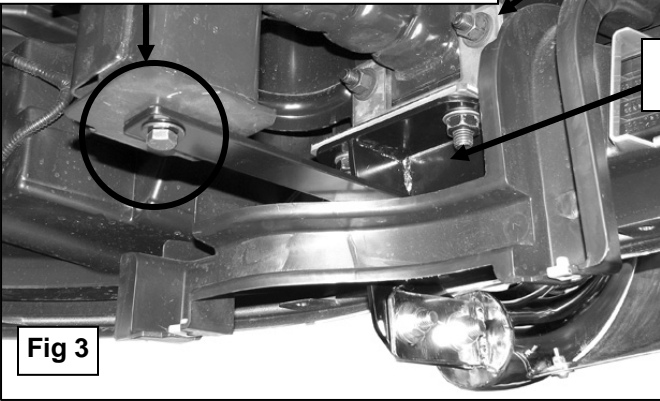

Fig 3

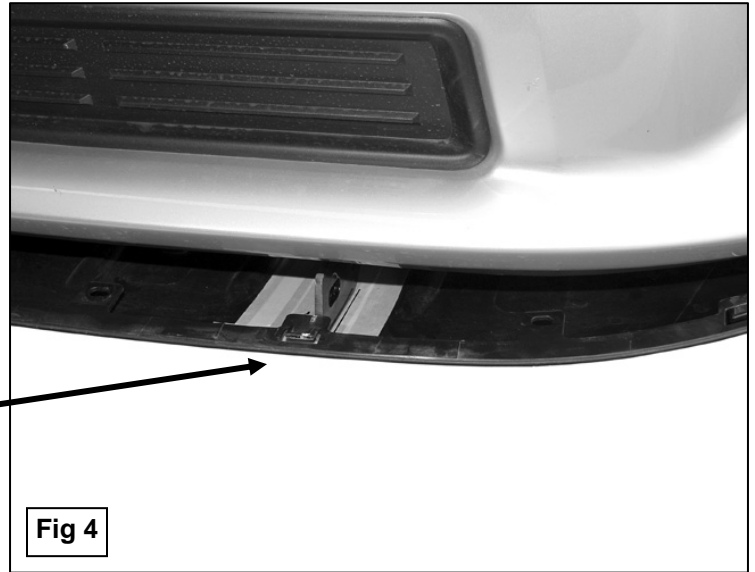

Fig 4

Hold the splash guard up to the brackets
and mark location for cutting to clear
brackets. Cut only what is needed to
insert bracket through the splash guard.

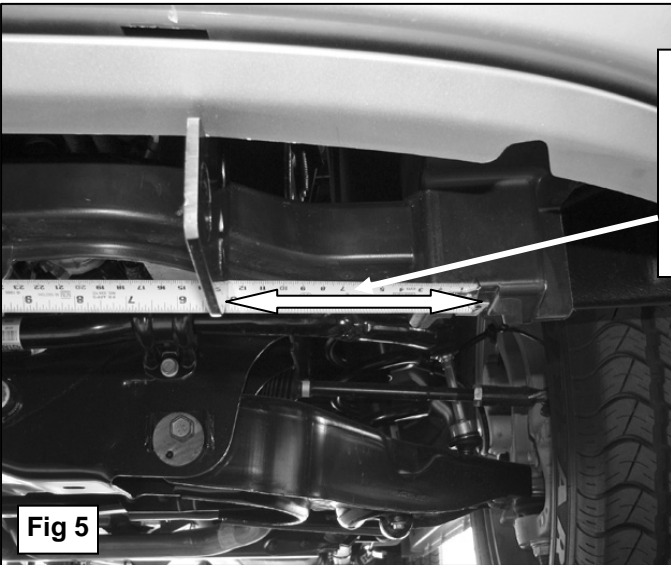

Fig 5

Measure from the mounting point
for the splash guard to the
bracket on the driver and
passenger sides. Use this
measurement as a reference point
to check location before cutting
the 1/2" wide x 4" long slot

Hole for mounting bolt

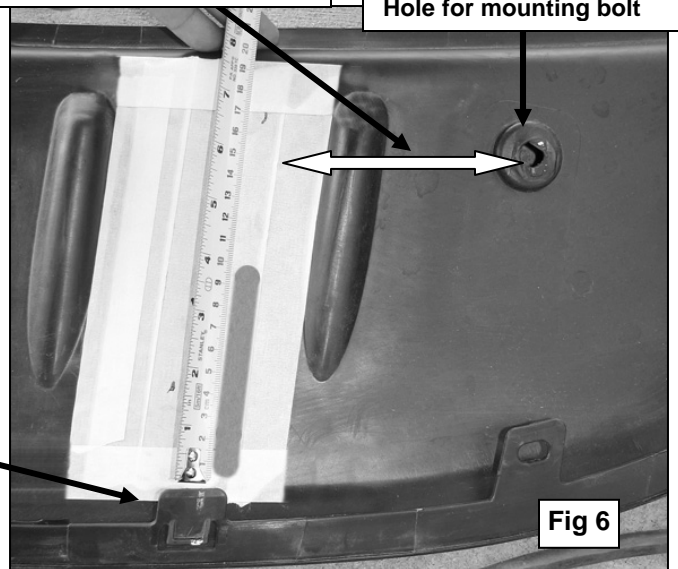
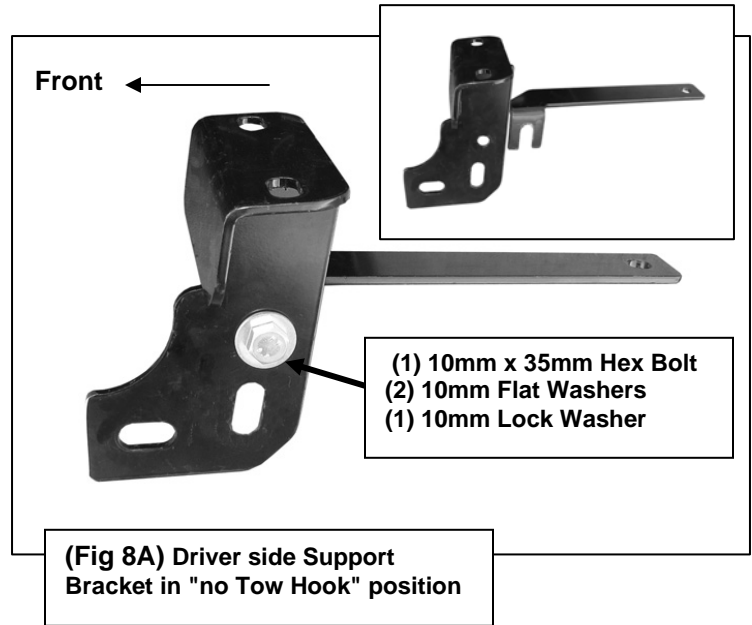
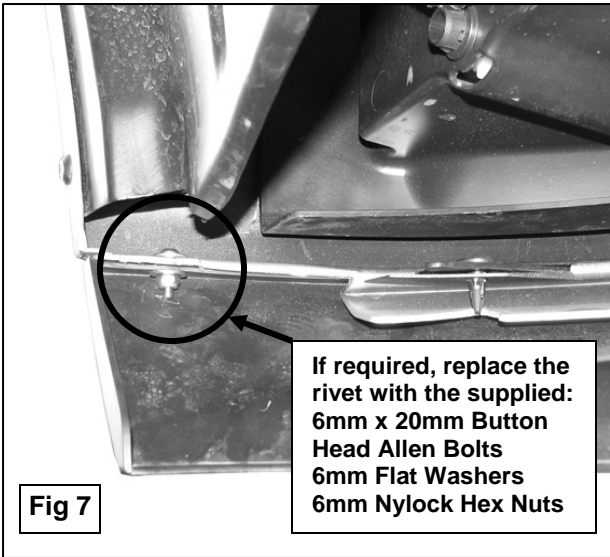

Fig 6

Cut only what is needed to insert bracket
through the splash guard. Do not cut
through the front edge of the splash guard

Driver Side Installation Pictured



Installation pictured without the splash guard for illustration

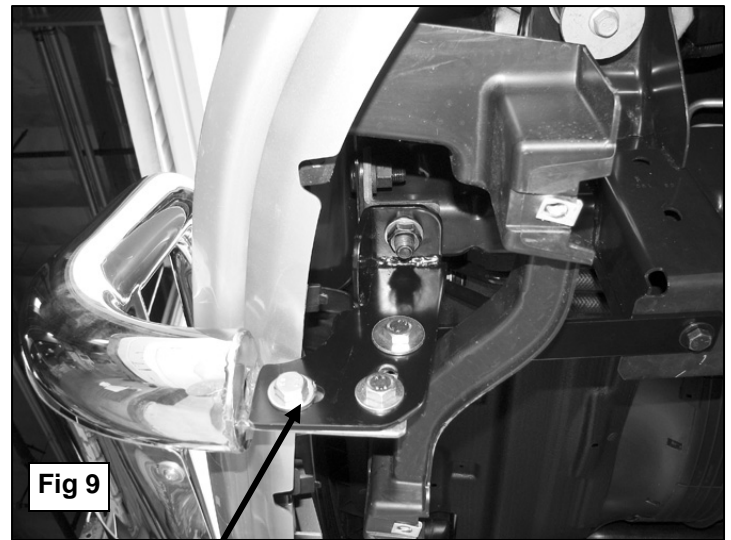
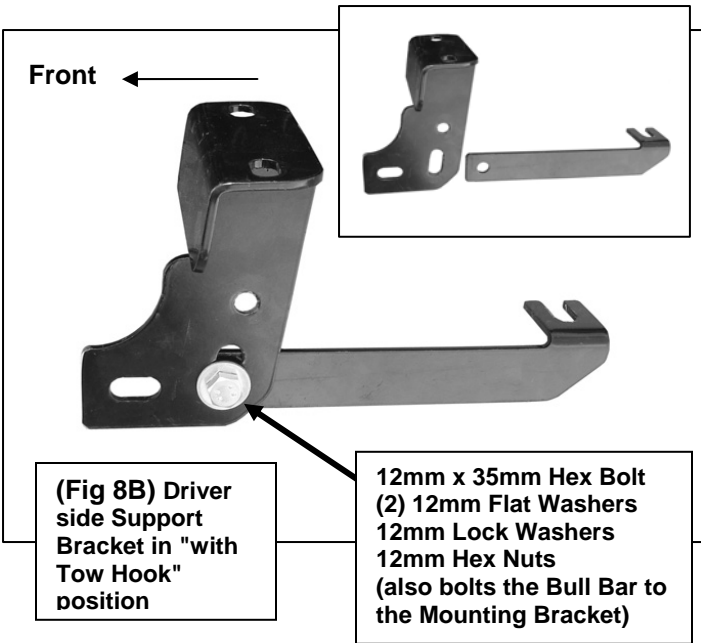

(2) 12mm x 35mm Hex Bolts
 (4) 12mm Flat Washers
 (2) 12mm Lock Washers
 (2) 12mm Hex Nuts

