

INSTALLATION INSTRUCTION

For Nissan Tian-Extended/king/Crew Cab 04-13 Armada 04-13









ITEM NO:4519

ATTENTION

1. Please read this installation instruction before installing this part.
When install it, please pay attention to protecting your vehicles.

2. When you use it, please check this parts at a fix time-lapse, such as one month or two month.

PARTS LIST

No	Name	Photo	Qty	Remarks	No	Name	Photo	Qty	Remarks
①	Mount Bracket1		6	lateral symmetry					
②	Hex Bolt		6	M8*30					
③	Flat Washer		6	M8					
④	Lock Washer		6	M8					
⑤	Flange Nut		6	M8					
⑥	"T"Bolt		6						
⑦	flat washer		24	M6					
⑧	LOCK NUT		24	M6					

Installation Diagram

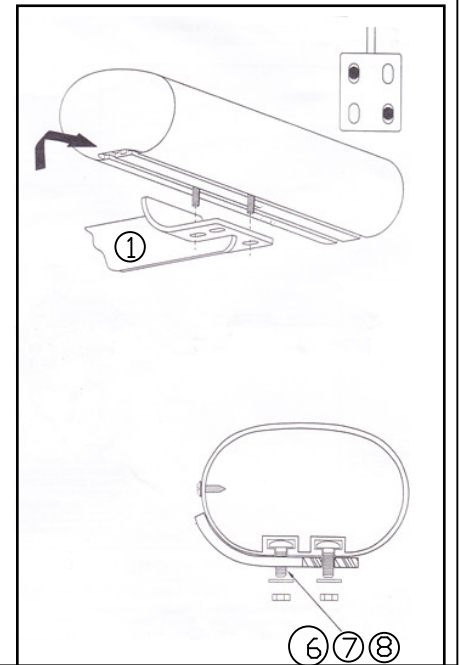
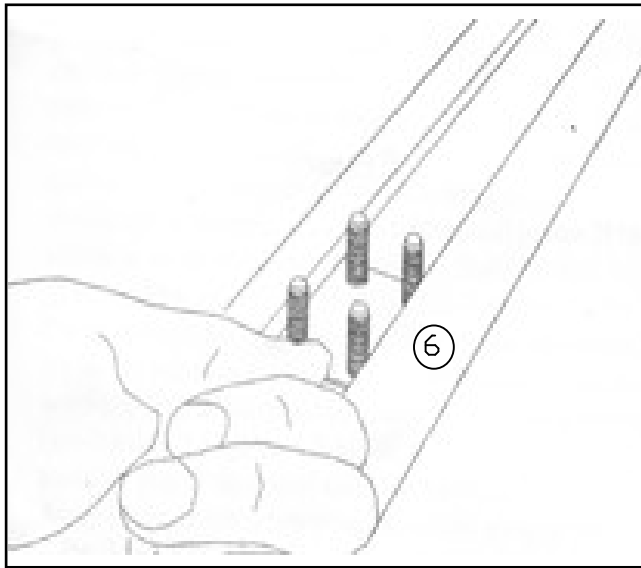
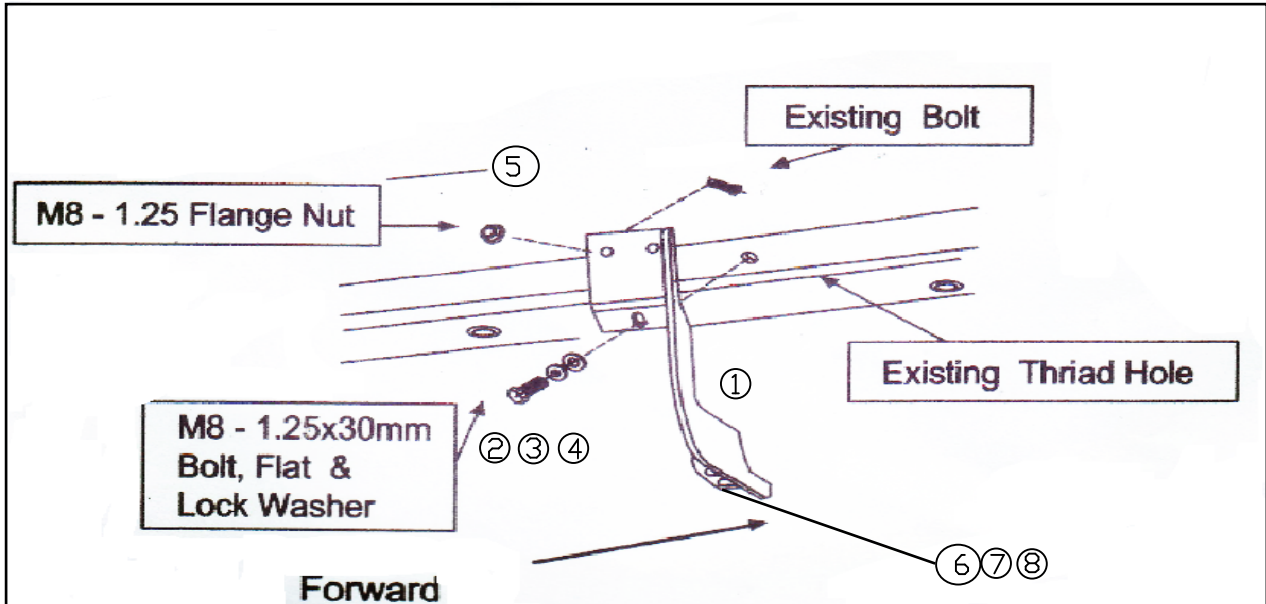

INSTALLATION STEPS

STEP 1: Check the parts in the box carefully if match above list .

STEP 2: Pls prepare the tools for installation, follow as: 10-12wrench, 14-17 wrench .

STEP 3: Put the mount bracket into the girder of the car, and tighten it with ②③④⑤.

STEP 4: Install the Side Bar to the mount bracket, and tighten it with ⑥⑦⑧ .

STEP 5: Installation is finished.