

Installation Instructions

I - Sheet Number BF23 Rev.B



Bugflector[®] - Bugflector II[®] - Carflector[®] - Chrome Hood Shield[™]

For proper installation and best possible fit, please read all instructions **BEFORE** you begin.
For technical assistance or to obtain missing parts, please call Customer Relations at 1-800-241-7219.

Important Safety Information



- CAUTION - Before driving, ensure that the hood shield is properly secured to vehicle.
- Do not use automatic "brush-style" car washes.
- Do not use cleaning solvents of any kind.
- Periodically check all components for tightness.

Contents **NOTE:** Actual product may vary from illustration.



Hood Shield

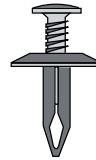

Fastener x4



Bump On x4

Tools Required



Car Wash Supplies



Clean Towel

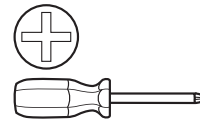

Phillips Screwdriver

Preparation Before Painting / Installation

- A trial fit is recommended to ensure proper positioning and fit.
- Check fit of parts before painting as we will not accept the return of modified or painted parts.
- Wash and dry your vehicle to remove any debris and/or dirt from the installation area.

Installation Steps **NOTE:** Actual application may vary slightly from illustrations.

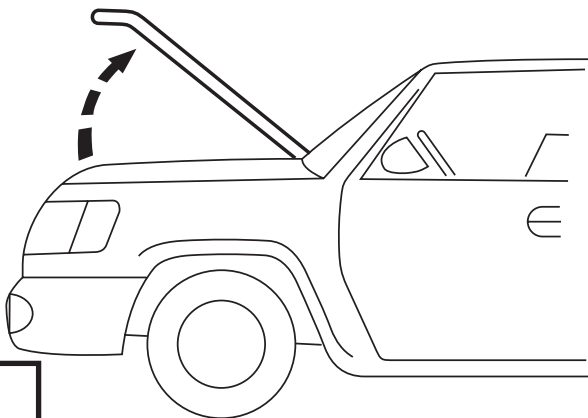

1

Locate (4) weatherstrip fasteners under hood that align with predrilled holes in hood shield. Remove and discard fasteners.

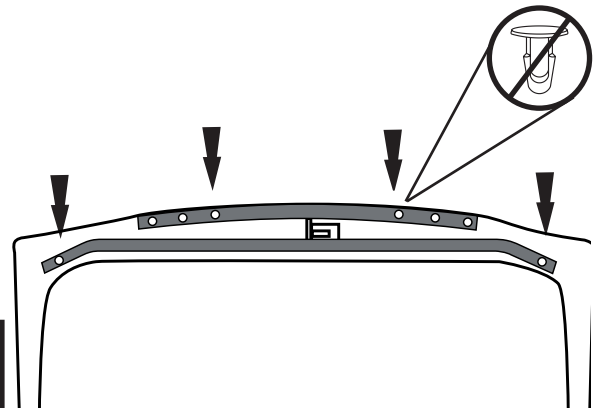

2

Installation Steps

NOTE: Actual application may vary slightly from drawings.

Align Hood Shield with holes in hood. The mounting flange of the hood shield is positioned **UNDER** the rubber trim.

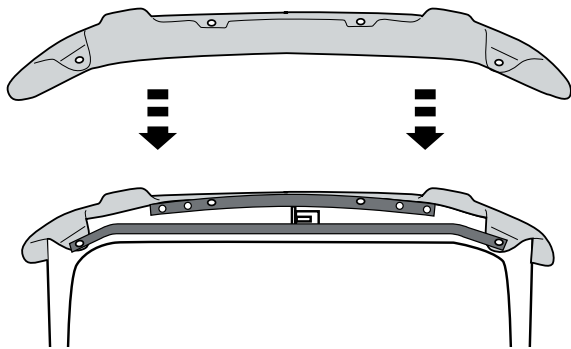

3

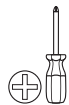

Using a phillips screwdriver, install (4) fasteners by screwing through the weatherstrip, hood shield, and hood.

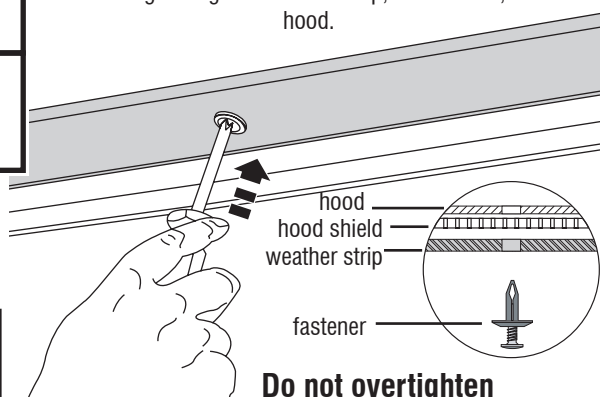

4

Do not overtighten

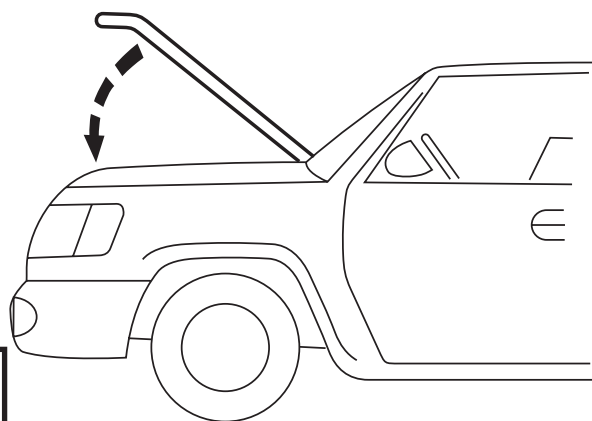

5



Install (4) bump ons.

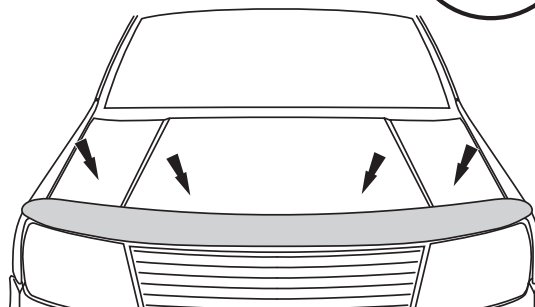
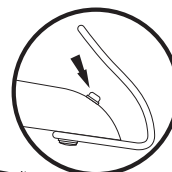

6

Care and Cleaning

- Wash only with mild soap & dry with a clean cloth.

Congratulations!

You have purchased one of the many quality Auto Ventshade™ branded products offered by Lund International, Inc. We take the utmost pride in our products and want you to enjoy years of satisfaction from your investment. We have made every effort to ensure that your product is top quality in terms of fit, durability, finish and ease of installation.



AUTO VENTSHADE™

Lund International, Ventshade Accessories Division

655 Raco Drive, Lawrenceville, GA 30045

800-241-7219 • Fax 770-339-5839 • Visit us at lundinternational.com



© 2006 Lund International, Inc. All rights reserved.
Auto Ventshade™, the Auto Ventshade™ logo, Chromeflector™, and the AVS™ logo are trademarks of Lund International, Inc.



Instructions d'installation

I- Feuille numéro BF23 Rév.B



Bugflector® - Bugflector II® - Carflector® - Chrome Hood Shield™

Pour obtenir une installation correcte et le meilleur ajustement possible, lire toutes les instructions AVANT de commencer. Pour toute assistance technique ou obtention de pièces manquantes, appeler le service des relations avec la clientèle au 1-800-241-7219.

Informations importantes concernant la sécurité



- ATTENTION – Avant de conduire, s'assurer que le pare-insectes est solidement assujettie sur le véhicule.
- Ne pas utiliser les stations de lavage de voitures à brosse.
- Ne pas utiliser de solvants.
- Vérifier régulièrement le serrage des composants.

Contenu **NOTE:** Le produit réel peut changer de l'illustration.



Pare-insectes

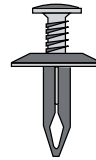

Attache (4)



Butoirs (4)

Outils nécessaires



Fournitures pour lavage de voiture

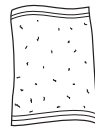

Serviette propre

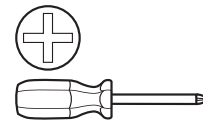

Tournevis Phillips

Préparation pour la peinture/l'installation

- Il est recommandé de procéder à un essai pour s'assurer que le positionnement et l'ajustement sont corrects.
- Vérifier l'ajustement des pièces avant peinture, car nous n'acceptons pas le retour de pièces modifiées ou peintes.
- Laver les glissières de glaces de la portière du véhicule pour éliminer toute poussière et tous débris.
- Sécher les glissières avec une serviette propre.

Étapes d'installation

REMARQUE : La méthode d'application peut être légèrement différente de celle représentée par les illustrations.

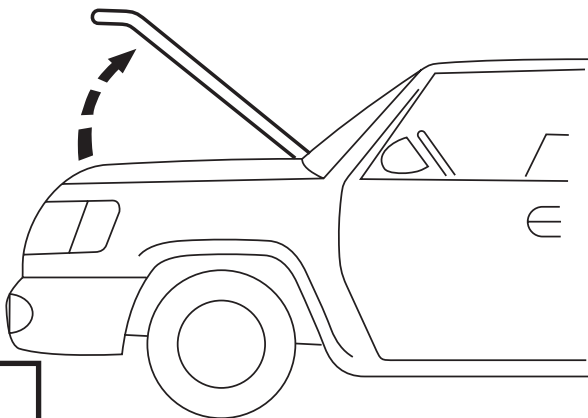

1

Localiser, sous le capot, les (4) fixations en caoutchouc d'étanchéité qui s'alignent sur les trous prépercés du pare-insectes. Retirer ces fixations et les jeter.

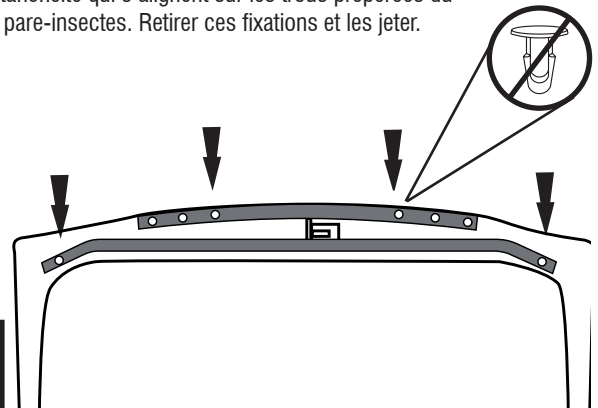

2

Étapes d'installation

REMARQUE : La méthode d'application peut être légèrement différente de celle représentée par les illustrations.

Aligner le pare-insectes et les trous du capot. La collerette de montage du pare-insectes se place **AU-DESSOUS** de la garniture en caoutchouc.

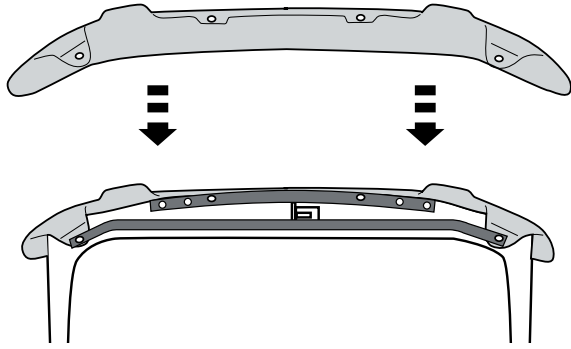

3

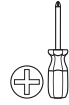

À l'aide d'un tournevis cruciforme, installer (4) fixations en les vissant dans le caoutchouc d'étanchéité, le pare-insectes et le capot.

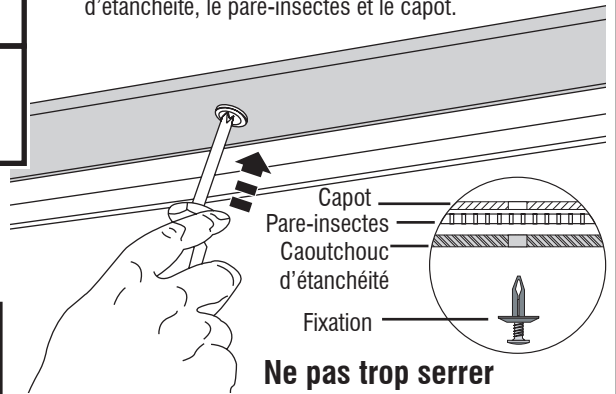

4

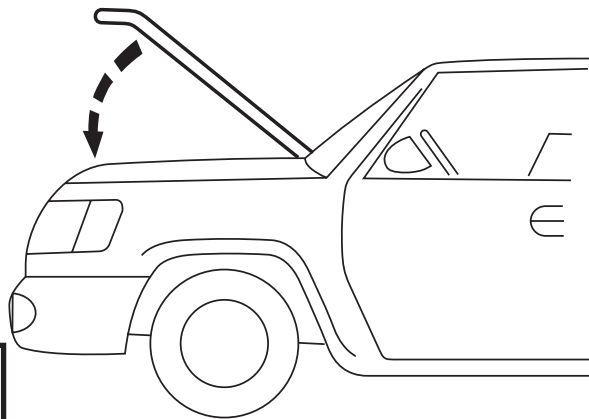

5

Installer (4) butoirs.

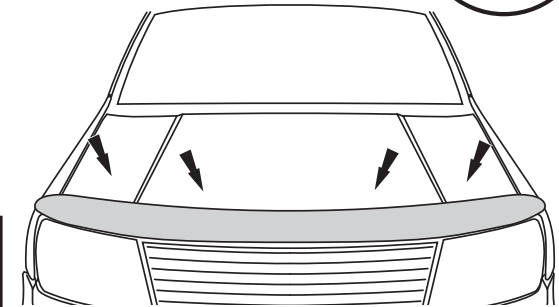
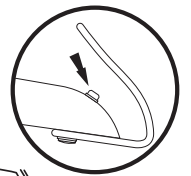

6

Entretien et nettoyage

- Laver exclusivement avec de l'eau savonneuse et sécher avec un chiffon propre.

Félicitations !

Vous avez acheté l'un des nombreux produits de qualité Auto Ventshade™ fabriqués par Lund International, Inc. Nous sommes extrêmement fiers de nos produits et souhaitons que vous tiriez des années de satisfaction de votre investissement. Nous avons pris toutes les mesures nécessaires pour assurer que ce produit est d'une qualité supérieure en ce qui concerne l'ajustement, la durabilité, la finition et la facilité d'installation.



AUTO VENTSHADE™

Lund International, Ventshade Accessories Division

655 Raco Drive, Lawrenceville, GA 30045, USA

800-241-7219 • Fax 770-339-5839 • Visitez notre site lundinternational.com



© 2006 Lund International, Inc. Tous droits réservés.
Auto Ventshade™ le logo Auto Ventshade™, Chromeflector™ et le logo AVS™ sont des marques déposées de Lund International, Inc.



Instrucciones de instalación

Hoja informativa N.º BF23 Rev. B



Bugflector® - Bugflector II® - Carflector® - Chrome Hood Shield™

Para una instalación adecuada y el mejor ajuste posible, lea todas las instrucciones ANTES de comenzar. Si desea recibir asistencia técnica u obtener piezas faltantes, llame al Servicio al cliente al 1-800-241-7219.

Información importante de seguridad



- PRECAUCIÓN - Antes de conducir, asegúrese de que la visera deflectora esté correctamente anclada al vehículo.
- No utilice servicios automáticos de limpieza de vehículos que utilizan cepillos.
- No utilice limpiadores al solvente de ningún tipo.
- Compruebe periódicamente que todos los componentes estén ajustados.

Contenido **NOTA:** El producto real puede variar de la ilustración.



Cubierta para capó

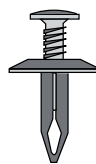

Sujetador (4)



Soporte (2)

Herramientas necesarias



Equipo de limpieza de vehículos



Toalla limpia

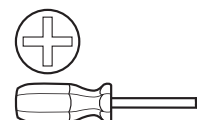

Destornillador Phillips

Preparación antes de pintar o instalar

- Se recomienda realizar un ajuste de prueba para asegurar el posicionamiento y ajuste correctos.
- Compruebe que las piezas se ajusten correctamente antes de pintarlas, ya que no aceptaremos la devolución de piezas modificadas o pintadas.
- Lave los canales de la ventanilla del vehículo para quitar los desechos y la suciedad.
- Seque los canales de la ventanilla con una toalla limpia.

Pasos de instalación **NOTA:** El uso real puede variar levemente de ilustraciones.

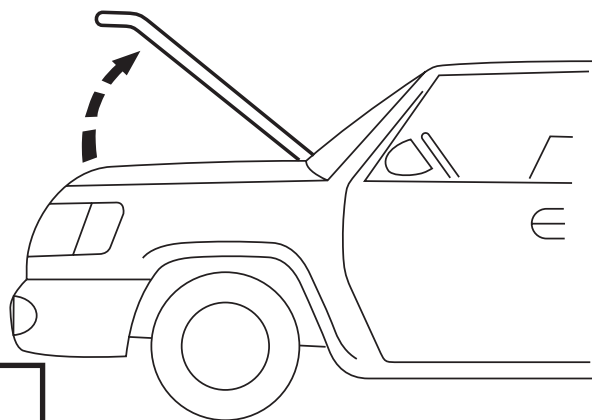

1

Ubique los (4) sujetadores de burlete debajo del capó que se alinean con los orificios realizados previamente en la cubierta para capó. Quite y deseche los sujetadores.

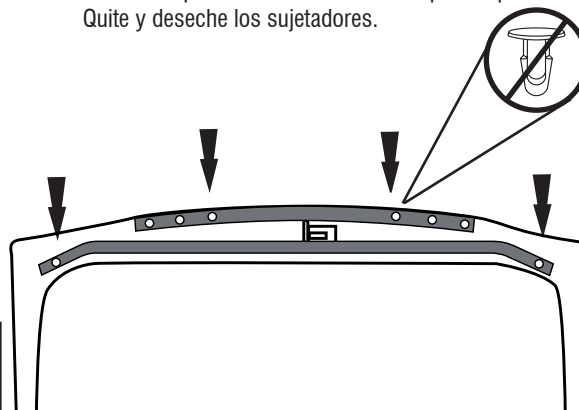

2

Pasos de instalación

NOTA: El uso real puede variar levemente de ilustraciones.

Alinee los orificios de la cubierta para capó con los orificios en el capó. El reborde de colocación de la cubierta para capó se coloca **DEBAJO** de la banda de goma.

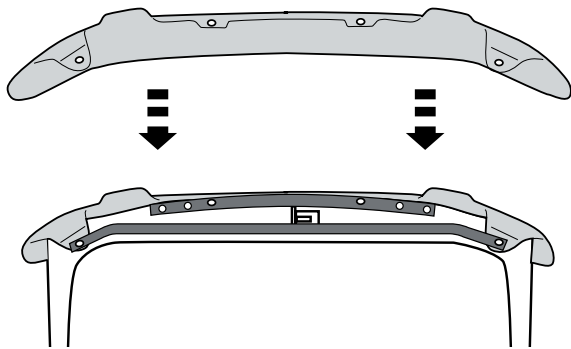

3

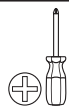

Con un destornillador Phillips, coloque los (4) sujetadores atornillando a través del burlete, la cubierta para capó y el capó.

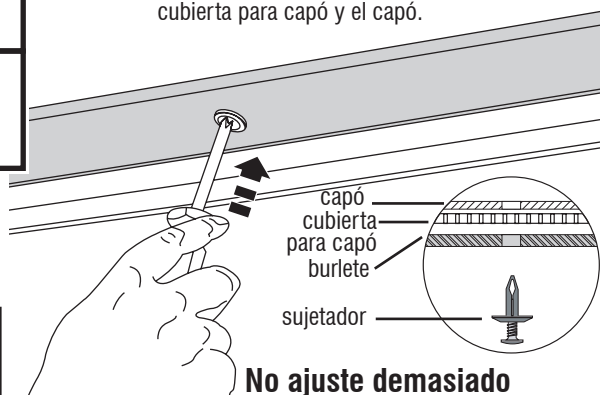

4

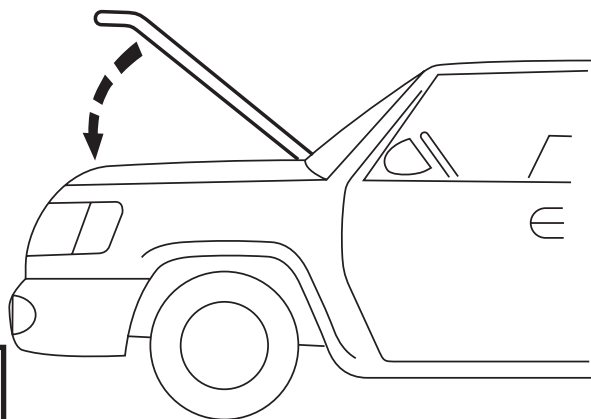

5

Coloque (4) soportes.

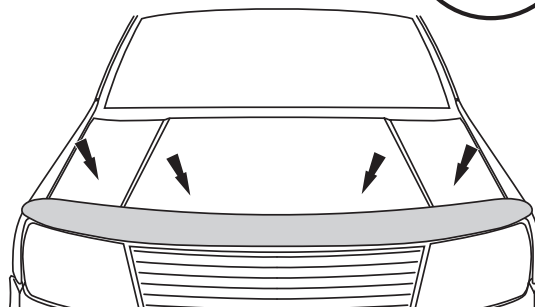
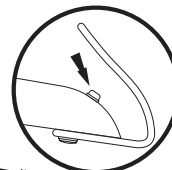

6

Cuidado y limpieza

- Limpie solamente con agua jabonosa tibia y seque con un paño limpio.

Felicidades

Usted ha comprado uno de los tantos artículos de calidad de Auto Ventshade™ ofrecidos por Lund International, Inc. Nuestros productos son nuestro mayor orgullo. Deseamos que disfrute de años de satisfacción con su inversión. Hemos realizado todos los esfuerzos para asegurarnos de que su producto sea de la mejor calidad en cuanto a ajuste, durabilidad, acabado y facilidad de instalación.



AUTO VENTSHADE™

Lund International, Ventshade Accessories Division

655 Raco Drive, Lawrenceville, GA 30045

800-241-7219 • Fax 770-339-5839 • Visite nuestro sitio Web: lundinternational.com



© 2006 Lund International, Inc. Todos los derechos reservados.
™ Auto Ventshade™ el logo de Auto Ventshade™, Chromeflector™ y el logo de AVS™ son marcas comerciales de Lund International, Inc.

