

Installation Instructions

I - Sheet Number BF37 Rev.C



Bugflector[®] - Bugflector II[®] - Carflector[®] - Chrome Hood Shield[™]

For proper installation and best possible fit, please read all instructions **BEFORE** you begin.
For technical assistance or to obtain missing parts, please call Customer Relations at 1-800-241-7219.

Important Safety Information



- CAUTION - Before driving, ensure that the hood shield is properly anchored to vehicle.
- Do not use automatic "brush-style" car washes.
- Do not use cleaning solvents of any kind.
- Periodically check all components for tightness.

Contents



Hood Shield



bump-on
x4

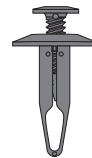

Fastener
x2

Tools Required

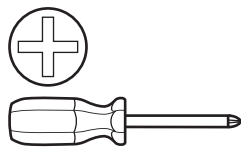

Screwdriver

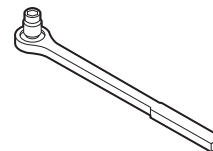

Socket Set

Preparation Before Painting / Installation

- A trial fit is recommended to ensure proper positioning and fit.
- Check fit of parts before painting as we will not accept the return of modified or painted parts.
- Wash your vehicle's hood to remove any debris and/or dirt.
- Dry the hood with a clean towel.

Installation Steps

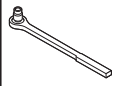

Raise hood. Remove and keep front grill hardware. Remove grill.

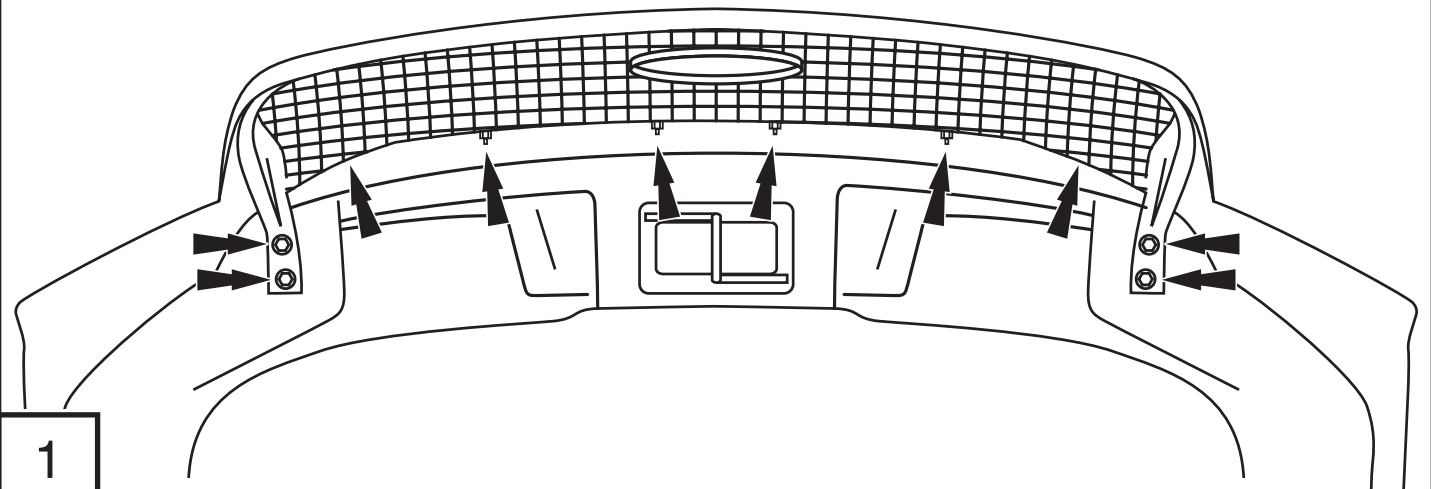

1

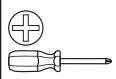

Align hood shield on center of hood. Secure with (2) fasteners. **DO NOT OVERTIGHTEN.**

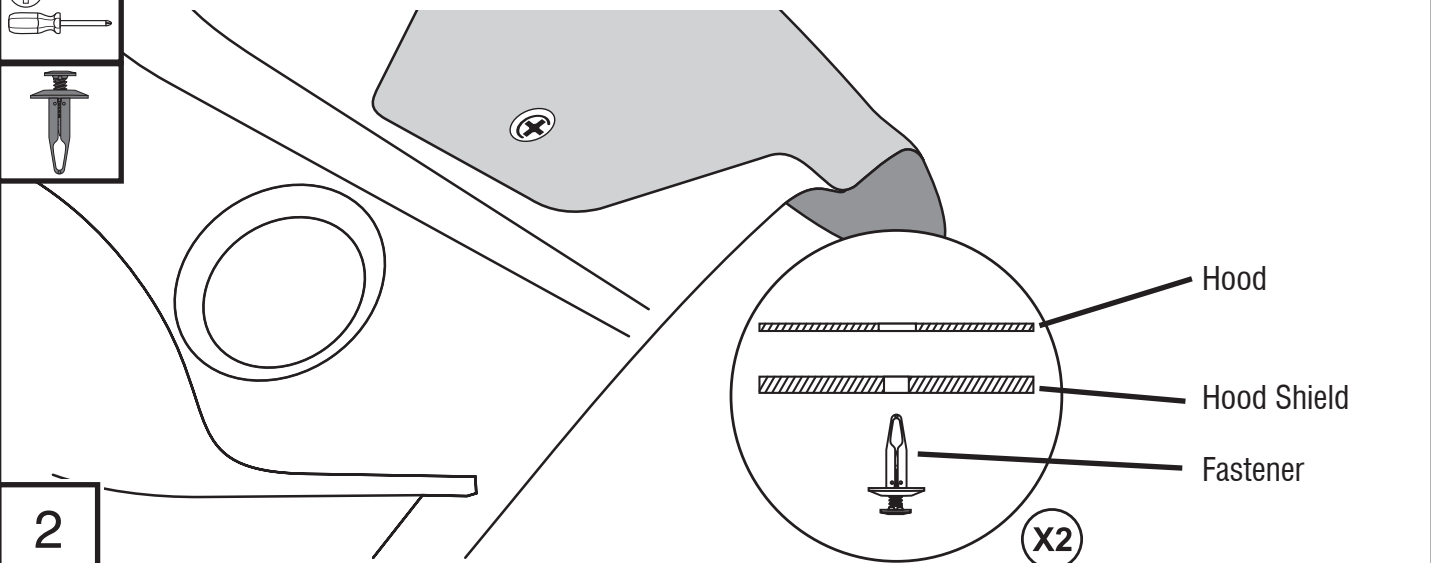

2

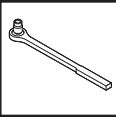

Replace grill with hardware.

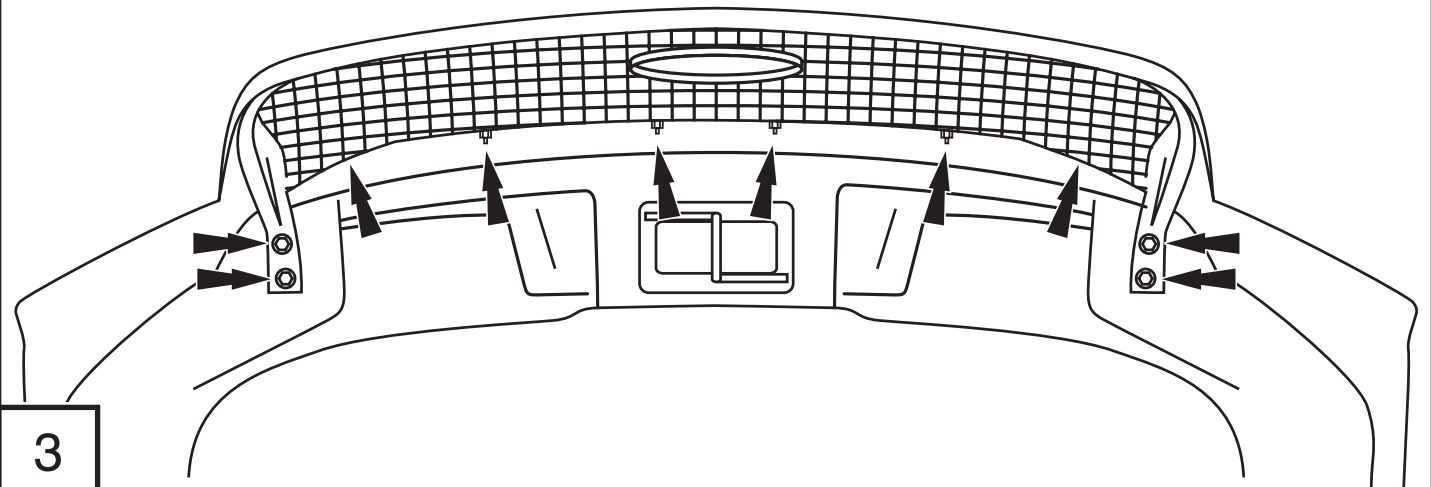

3

Installation Steps



Close hood. Apply bump-ons to hood behind hood shield.

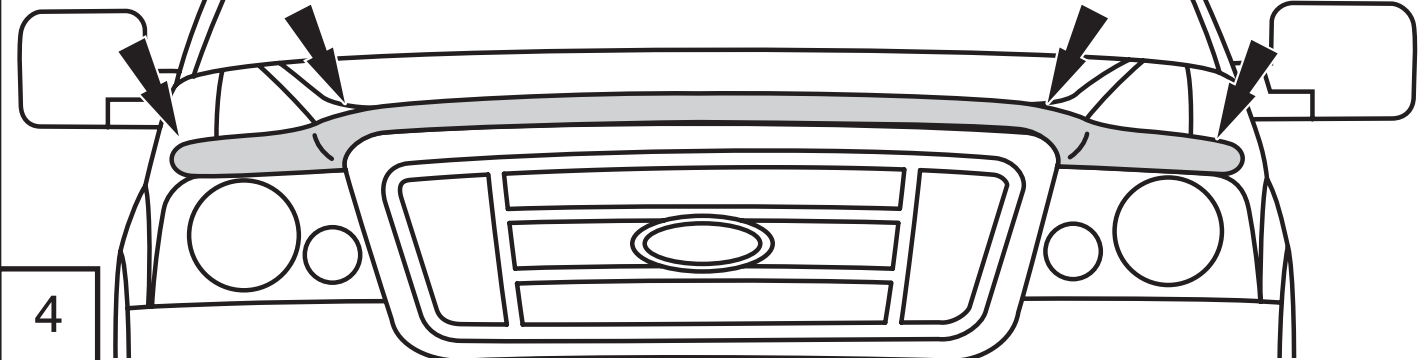
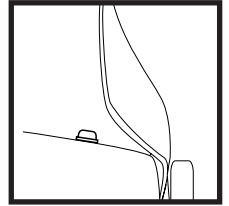

Care and Cleaning

- Wash only with mild soap & dry with a clean cloth.

Congratulations!

You have purchased one of the many quality items offered by Auto Ventshade. We take the utmost pride in our products and want you to enjoy years of satisfaction from your investment. We have made every effort to ensure that your product is top quality in terms of fit, durability, finish and ease of installation.



AUTO VENTSHADE™

Lund International, Ventshade Accessories Division

655 Raco Drive, Lawrenceville, GA 30045

800-241-7219 • Fax 770-339-5839 • Visit us at lundinternational.com



© 2006 Lund International, Inc. All rights reserved.
Auto Ventshade™, the Auto Ventshade™ logo, Chromeflector™, and the AVS™ logo are trademarks of Lund International, Inc.





Bugflector[®] - Bugflector II[®] - Carflector[®] - Chrome Hood Shield[™]

Pour obtenir une installation correcte et le meilleur ajustement possible, lire toutes les instructions **AVANT** de commencer.
Pour toute assistance technique ou obtention de pièces manquantes, appeler le service des relations avec la clientèle au 1-800-241-7219

Informations importantes concernant la sécurité



- ATTENTION – Avant de conduire, s'assurer que le pare-insectes est bien assujéti sur le véhicule.
- Ne pas utiliser les stations de lavage de voitures à brosses.
- Ne pas utiliser de solvants.
- Vérifier régulièrement le serrage des composants.

Contenu



Pare-insectes



Butoir
(4)



Boulon
(2)

Outils nécessaires

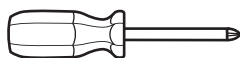

Tournevis

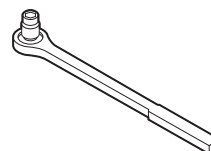

Jeu de douilles

Préparation pour la peinture/l'installation

- Il est recommandé de procéder à un essai pour s'assurer que le positionnement et l'ajustement sont corrects.
- Vérifier l'ajustement des pièces avant peinture, car nous n'acceptons pas le retour de pièces modifiées ou peintes.
- Laver le véhicule pour éliminer toute poussière et tous débris.
- Sécher le capot avec une serviette propre.

Étapes d'installation

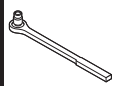

Soulever le capot. Retirer la quincaillerie de montage de la calandre et la mettre de côté. Retirer la calandre.

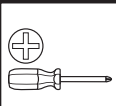
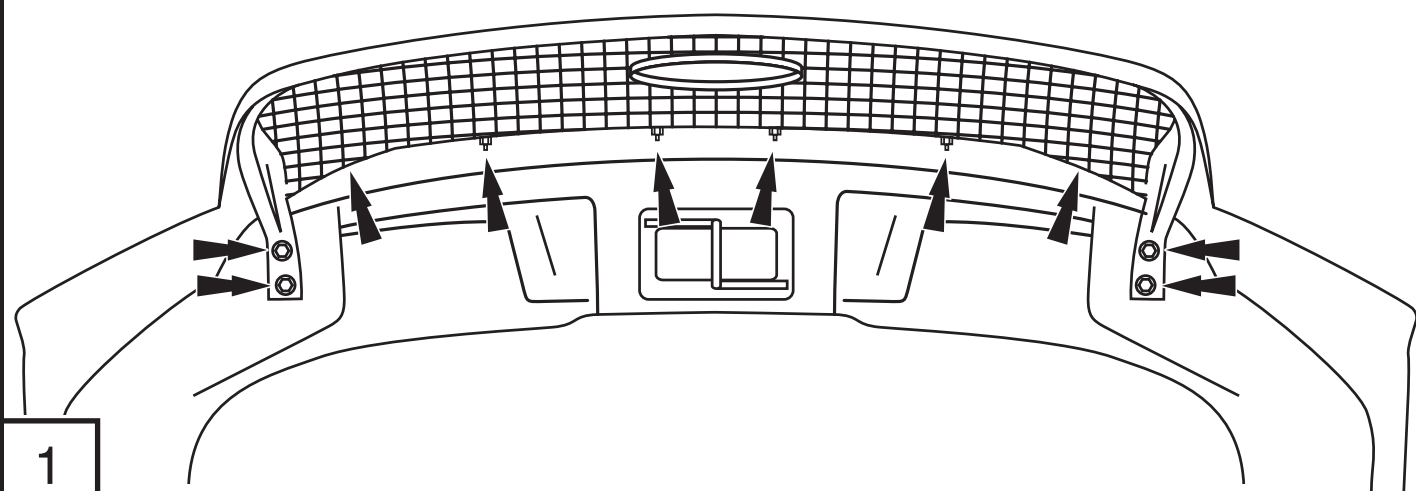

Aligner le pare-insectes sur le centre du capot. L'assujettir avec (2) vis. **NE PAS TROP SERRER.**

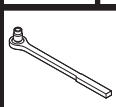
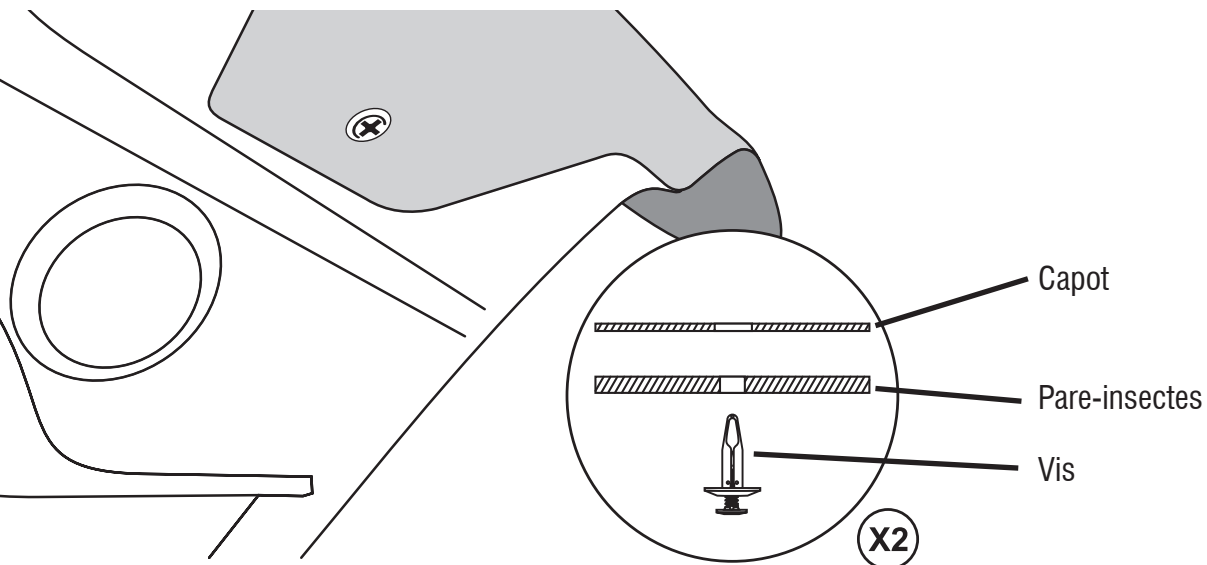
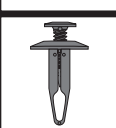

Remettre la calandre en place et l'assujettir avec sa quincaillerie.

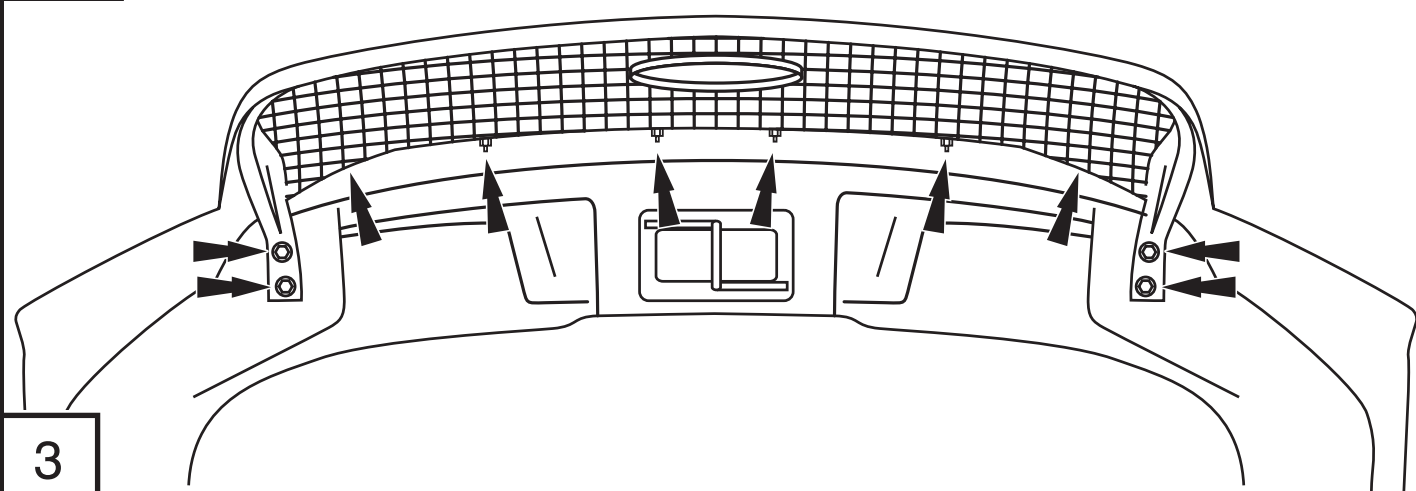

Étapes d'installation



Fermer le capot. Aligner les butoirs sur le capot, derrière le pare-insectes.

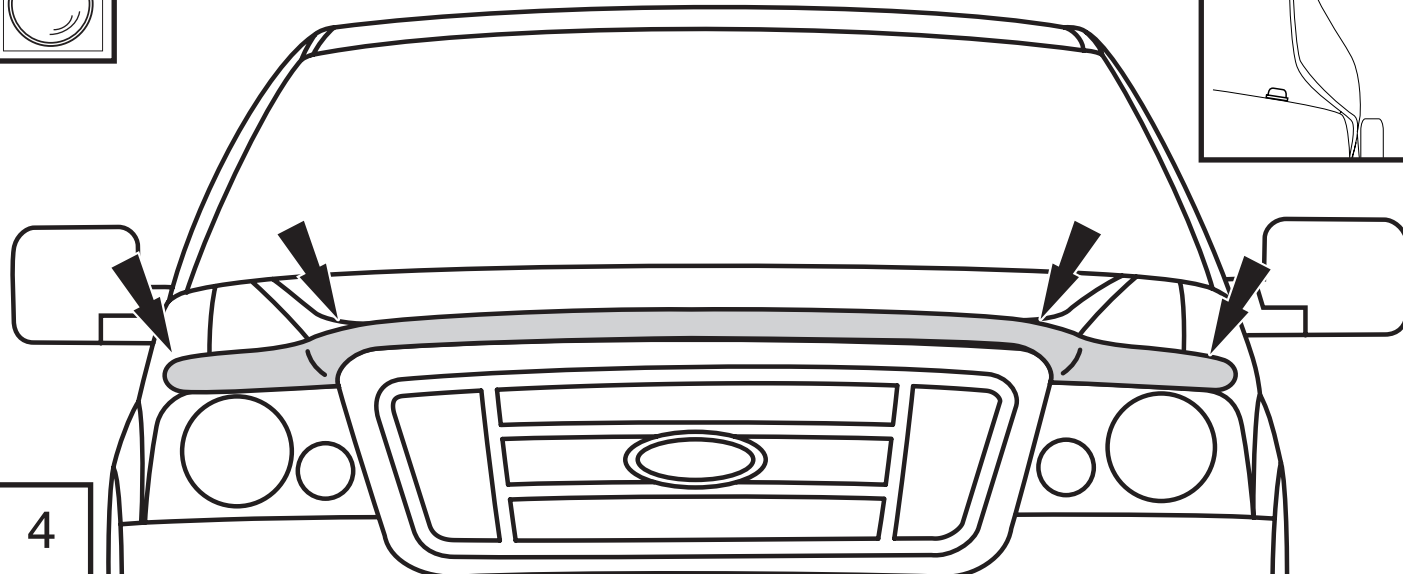
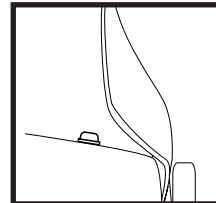

Entretien et nettoyage

- Laver exclusivement avec de l'eau savonneuse et sécher avec un chiffon propre.

Félicitations !

Vous avez acheté l'un des nombreux produits de qualité fabriqués par Auto Ventshade. Nous sommes extrêmement fiers de nos produits et souhaitons que vous tiriez des années de satisfaction de votre investissement. Nous avons pris toutes les mesures nécessaires pour assurer que ce produit est d'une qualité supérieure en ce qui concerne l'ajustement, la durabilité, la finition et la facilité d'installation.



AUTO VENTSHADE™

Lund International, Ventshade Accessories Division

655 Raco Drive, Lawrenceville, GA 30045, USA

800-241-7219 • Fax 770-339-5839 • Visitez notre site lundinternational.com

© 2006 Lund International, Inc. Tous droits réservés.

™ Auto Ventshade™ le logo Auto Ventshade™, Chromeflector™ et le logo AVS™ sont des marques déposées de Lund International, Inc.





Bugflector[®] - Bugflector II[®] - Carflector[®] - Chrome Hood Shield[™]

Para una instalación adecuada y el mejor ajuste posible, lea todas las instrucciones ANTES de comenzar. Si desea recibir asistencia técnica u obtener piezas faltantes, llame al Servicio al cliente al 1-800-241-7219.

Información importante de seguridad



- PRECAUCIÓN - Antes de conducir, asegúrese de que la cubierta para capó esté correctamente anclada al vehículo.
- No utilice servicios automáticos de limpieza de vehículos que utilizan cepillos.
- No utilice limpiadores al solvente de ningún tipo.
- Compruebe periódicamente que todos los componentes estén ajustados.

Contenido



Cubierta para capó



soporte
x4



Sujetador
x2

Herramientas necesarias

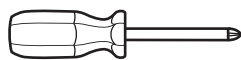

Destornillador

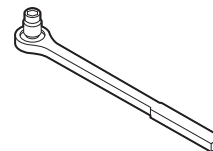

Juego de de llaves de cubo

Preparación antes de pintar o instalar

- Se recomienda realizar un ajuste de prueba para asegurar el posicionamiento y ajuste correctos.
- Compruebe que las piezas se ajusten correctamente antes de pintarlas, ya que no aceptaremos la devolución de piezas modificadas o pintadas.
- Lave el capó del vehículo para quitar los desechos y la suciedad.
- Seque el capó con una toalla limpia.

Pasos de instalación

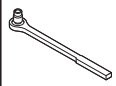

Levante el capó. Quite y guarde la tornillería de la parrilla delantera.
Quite la parrilla.

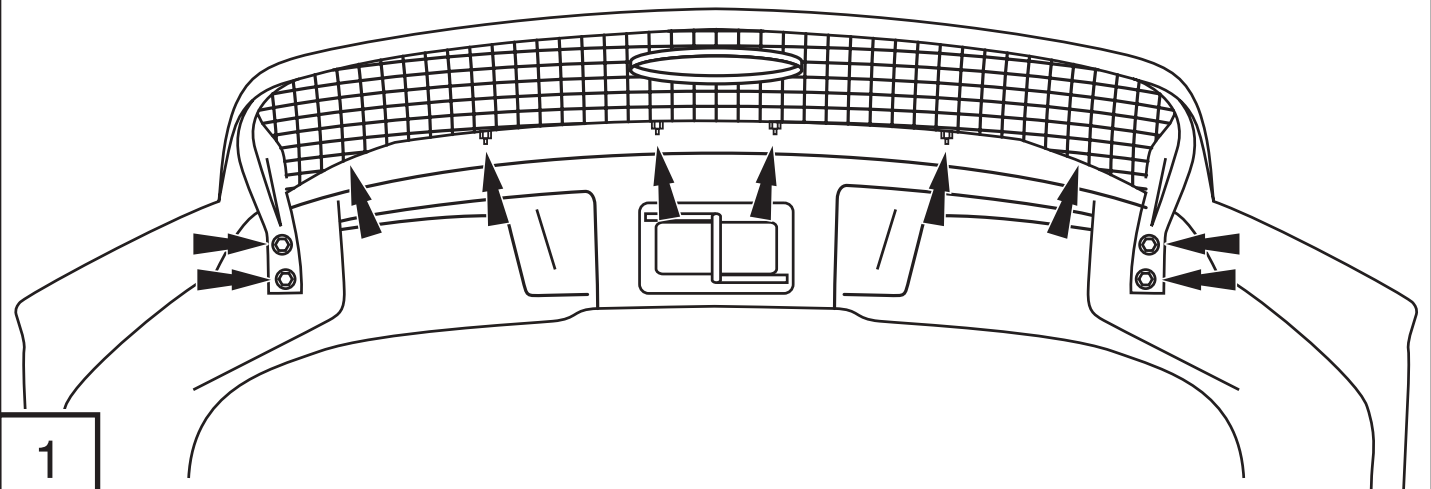

1

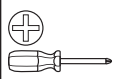

Alinee la cubierta para capó en el centro del capó. Asegure con (2) sujetadores. **NO AJUSTE DEMASIADO.**

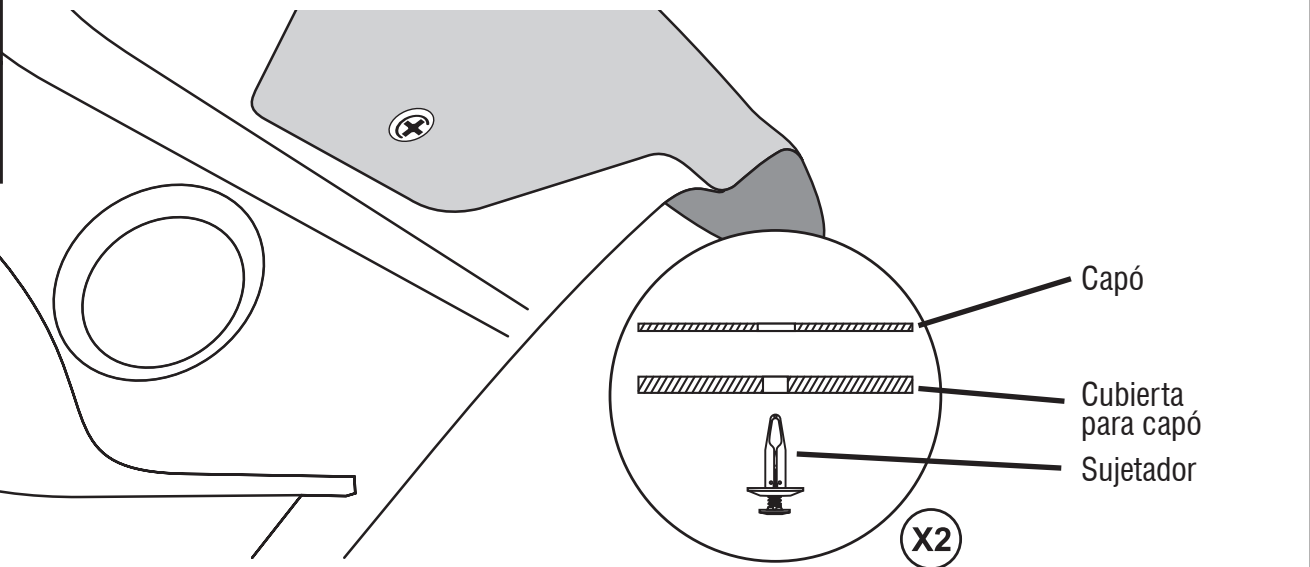

2

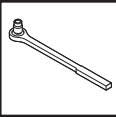

Vuelva a colocar la parrilla con la tornillería.

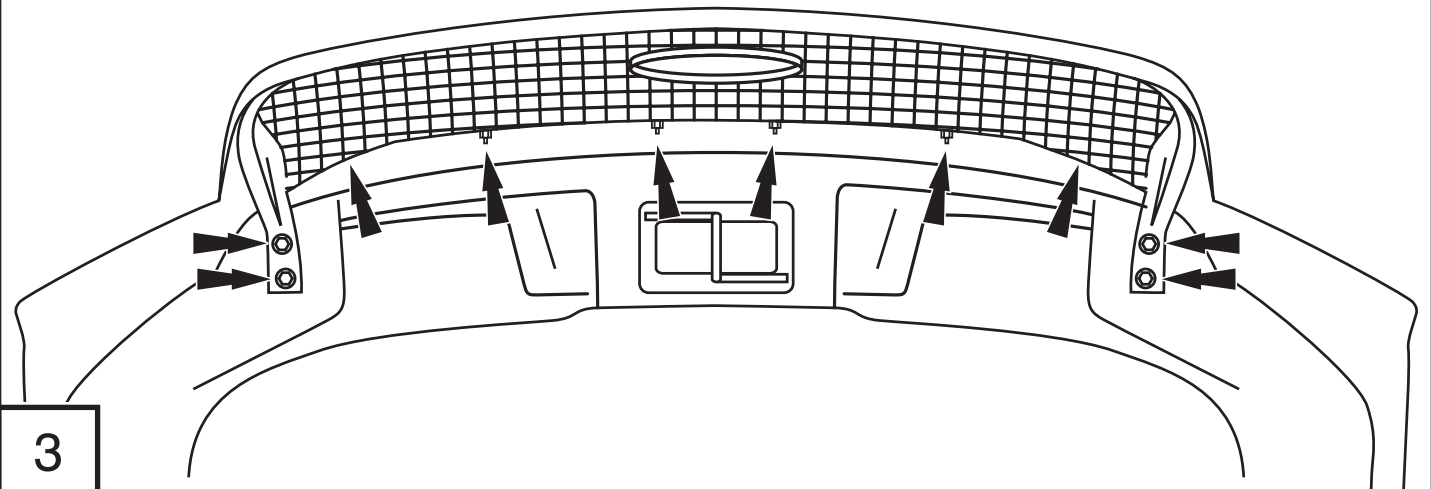

3

Pasos de instalación



Cierre el capó. Coloque los soportes en el capó detrás de la cubierta para capó.

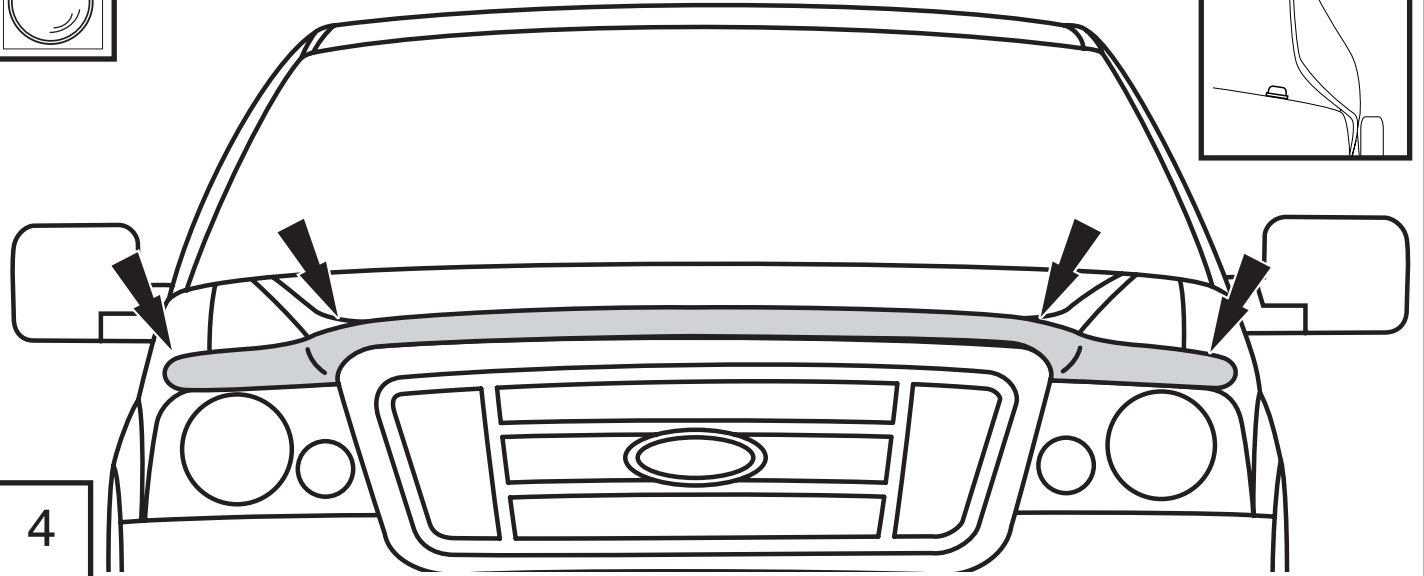
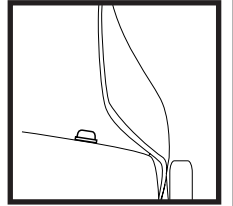

Cuidado y limpieza

- Limpie solamente con agua jabonosa tibia y seque con un paño limpio.

Felicidades

Usted ha comprado uno de los tantos artículos de calidad de Auto Ventshade. Nuestros productos son nuestro mayor orgullo. Deseamos que disfrute de años de satisfacción con su inversión. Hemos realizado todos los esfuerzos para asegurarnos de que su producto sea de la mejor calidad en cuanto a ajuste, durabilidad, acabado y facilidad de instalación.



AUTO VENTSHADE™

Lund International, Ventshade Accessories Division

655 Raco Drive, Lawrenceville, GA 30045

800-241-7219 • Fax 770-339-5839 • Visite nuestro sitio Web: lundinternational.com



© 2006 Lund International, Inc. Todos los derechos reservados.

™ Auto Ventshade™ el logo de Auto Ventshade™, Chromeflector™ y el logo de AVS™ son marcas comerciales de Lund International, Inc.

