

2007.5-12 6.7L Dodge Cummins

BD Remote Mount Exhaust Brake

Installation Instructions

1027340	2007.5-2012	4" Exhaust
----------------	--------------------	-------------------

Serial # _____

Date Purchased _____

Purchased from _____

Installed by _____

***** Please read this manual before starting installation. *****
OWNER'S MANUAL - LEAVE IN GLOVE BOX

The brake pressure at idle is required to be checked and adjusted at time of install, at least two weeks after install, and at regular twice a year intervals.

TABLE OF CONTENTS

Welcome..... 3

Kit Contents 3

Special Tools Required 3

Accessories 3

Pre-Installation..... 4

Notes On Connectors..... 4

Installation..... 5

 Brake Valve Installation 5

 Air Solenoid Installation..... 7

 Air Hose Installation 8

Air Compressor Mounting Installation 9

 Compressor & Regulator Installation..... 11

Regulator Assembly 11

 DFIV INSTALLATION 12

Accelerator Pedal Position Sensor Wiring (2007.5-12) 13

Brake Switch wiring for Speed Control to DFIV 14

Switch Install (Not required if using shifter-mounted switch) 15

Optional Manual Shifter Switch (Push-Pull Style) 17

Optional Manual Shifter Switch (Rocker Switch Style)..... 18

Wiring & Plumbing Diagram 19

 DFIV Adjustment & Testing..... 20

 DFIV Operation 20

Exhaust Back Pressure Testing Air Actuated Brakes 21

Maintenance..... 23

Operating Guidelines 23

Air Brake Troubleshooting Guide 25

Welcome

Thank you for purchasing a BD Exhaust Brake. This manual is divided into different areas to assist you with the installation and operation of your braking unit. We strongly suggest that you write down the kit and serial numbers of your unit in the spaces provided and retain this manual for any future reference.

Kit Contents

1	1127038	Valve Assembly	1	1321046	DFIV Application Kit
1	1220139	Regulator/Control Kit	2	1100400	4" Pipe Adapter
1	1030129-C	Compressor Kit	2	1100404	4" Marmon Clamp
1	1220113	Air Snorkel Kit	1	1100740	4" S/S Exhaust Clamp
1	1220048-C	Air Solenoid Assy.	1	1220100	Air Snorkel Kit
1	1321047	Generic DFIV- Relay Kit			

Special Tools Required

- Measuring tape or ruler
- Drill with 1/8", 3/16" bits and Unibit
- Sawsall or hacksaw
- Crimping Pliers
- Test light
- 1/4" Drive Socket Set
- Small bladed flat tip screwdriver
- Welder

Accessories

Description	Part #
Manual Transmission Shifter Switch Kit	1300210
Brake Pressure Gauge Kit	1030050
Boost Pressure Gauge Kit (30lbs.)	1030570
Transmission Gauge Kit (Auto Transmission)	1030583
Exhaust Temperature Gauge (Pyrometer)	1030512-I

BD Engine Brake Inc.

Plant Address: 33541 MacLure Rd. Abbotsford, BC, Canada V2S 7W2

U.S. Shipping Address: 88-446 Harrison St, Sumas, WA 98295 U.S. Mailing Address: P.O. Box 231, Sumas, WA 98295

Phone: 604-853-6096 | Fax: 604-853-8749 | Internet: www.bd-power.com

Pre-Installation

To prevent damage to electronic components, it is recommended that you disconnect both negative battery terminals before starting.

Please read this manual thoroughly before installing this exhaust brake.

Notes On Connectors

The kit includes a number of Posi-Tap™ connectors (Gray or Red/Black/Green or Yellow) to tap onto OEM wiring. It is important to select the correct color of connector so that it matches the gauge of the OEM wire that it is being installed on. Using the incorrect connector could cause an inadequate connection and/or the OEM wire could be severed.

OEM Wire	Posi-Tap™ Color
18-22ga	Gray or Red
12-18ga	Black
10-12ga	Green or Yellow

Though these connectors offer a quicker installation, the best option would be to solder the wires and isolate the joints with heat shrink or liquid electrical tape. Proper soldering techniques should be used to ensure adequate connections.

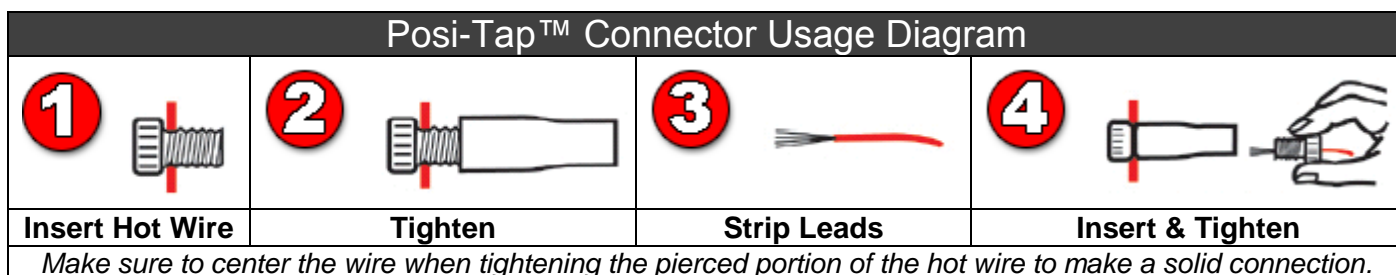

The ground terminals of the vehicle’s batteries should be disconnected before performing any piercing/posi-tapping onto any ECM/PCM wire.

Installation

Brake Valve Installation

***SAFETY*:** To prevent injury or damage raise the vehicle to a good working height with either a hoist or proper jack stands.

From underneath the vehicle, locate the turbo down pipe and the catalytic converter. You will need to cut a 7-1/4" section from this pipe. Although the pipe has a number of unusual bends, you will need to choose the straightest section possible, especially for the rear adapter of the brake, as this is a SS band clamp. As well mock up the installation of the brake so that when the brake cycles, the actuator will not come in contact with anything. Use a Sawsall or cutting disc to remove this section of pipe.

Clean off the cut ends of the intermediate pipe with a file to remove burrs left from cutting and then insert the adapter pipes onto each end of the now exposed pipes.

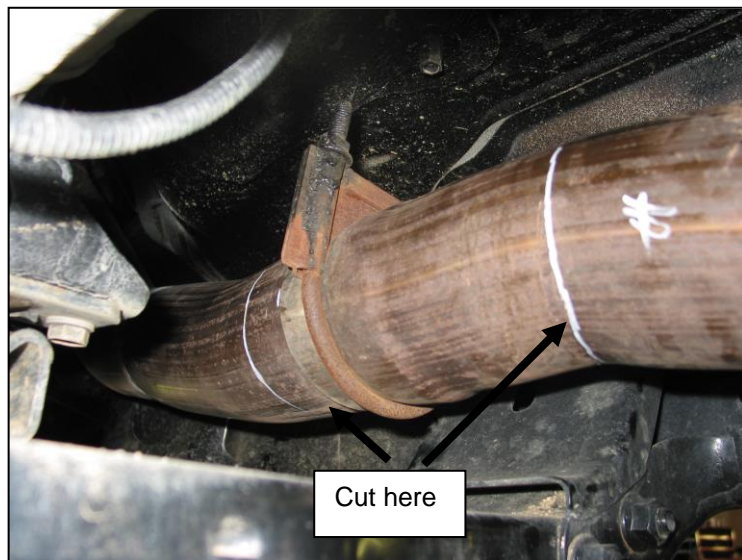

Insert the exhaust brake install with supplied 'V' band clamps. Be sure that the air cylinder bracket extends toward the rear of the vehicle.

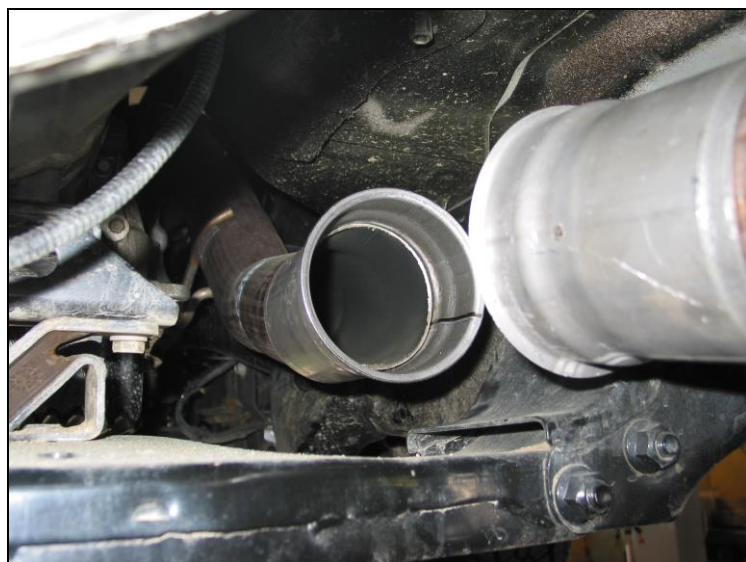

BD Engine Brake Inc.

Plant Address: 33541 MacLure Rd. Abbotsford, BC, Canada V2S 7W2

U.S. Shipping Address: 88-446 Harrison St, Sumas, WA 98295 U.S. Mailing Address: P.O. Box 231, Sumas, WA 98295

Phone: 604-853-6096 | Fax: 604-853-8749 | Internet: www.bd-power.com

Tighten all mounting nuts and bolts that secure the brake to the flanges.



Ensure the exhaust brake and rear exhaust sections are pushed all the way forward on the front pipe so that the front adapter flange is up against the stop that is on top of the front pipe section then WELD the adapter in place. Install the clamp on the rear exhaust adapter.

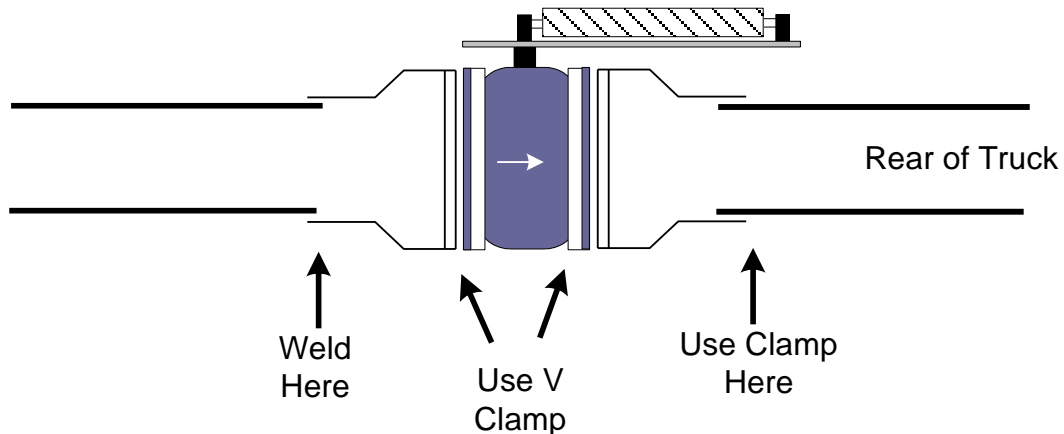

NOTE: SECURING THE FRONT ADAPTER WITH JUST A CLAMP WILL CAUSE LEAKAGE AND NOT ALLOW THE BRAKE TO OBTAIN FULL BRAKING PRESSURE.

Air Solenoid Installation

Just across from the exhaust brake on the passenger side frame rail you will notice a number of factory holes in the frame. Utilize one of these holes to mount the air solenoid assembly. Make sure the air solenoid is as close as possible to the exhaust brake to ensure quick engagement and disengagement of the brake. Clean the area around the hole as this will also be the ground point for the air solenoid wiring. Mount the air solenoid using the supplied hardware and attach the ring terminal on the brown ground wire to this point.



NOTE: To remove the plastic hose from the quick-connect coupler, push the outer ring toward the fitting and pull the hose out.

Air Hose Installation

Insert one end of the 1/4" plastic hose into the quick-connect coupler on the quick release valve on the brake air cylinder and route it over to the 90° fitting on the #1 port of the solenoid valve.

Cut the hose with a knife or a hose cutter, leaving some slack for routing (do NOT use side cutting pliers as the hose will be squashed and leak). Ensure the end is cleaned of any burrs.

Two air vent snorkel assemblies are supplied in the brake kit, one for the main air cylinder and one for the air solenoid. Each snorkel assembly has 14' of 1/4" plastic air hose with a grey filter on the end. Insert the free end of one snorkel assembly into the 90° fitting on the front of the brake air cylinder (the end of the cylinder where the rod comes out) and route it over to the air solenoid.

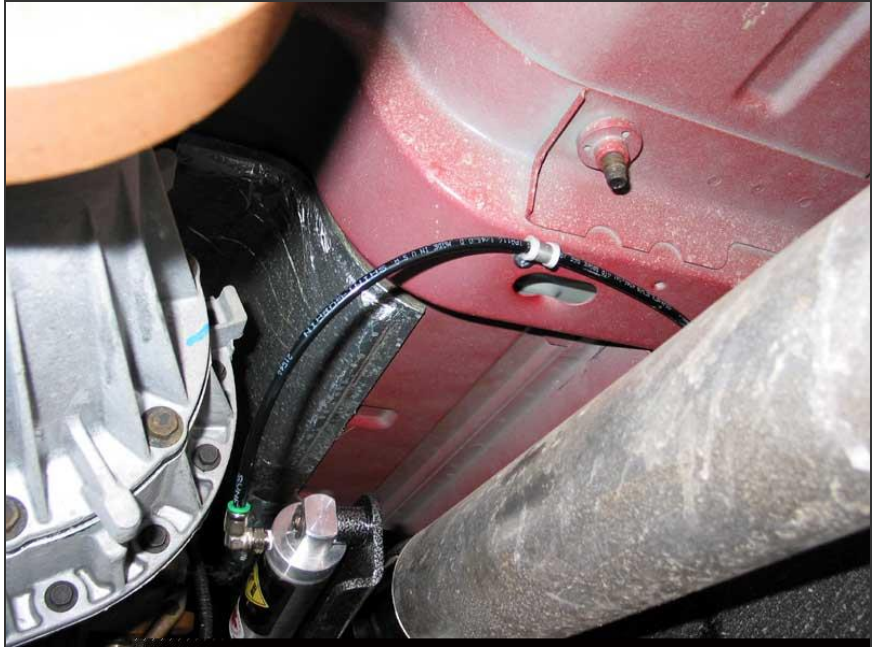

As indicated by the photo, secure the plastic hose by installing the clamps provided to the body of the cab. Drill a 1/8" pilot hole in the cab body as shown in the photo and secure the anchor clamps with the provided self-tapping screw.

CARE MUST BE TAKEN NOT TO KINK THE PLASTIC HOSE OR ROUTE IT NEAR A HEAT SOURCE.

Insert the open end of the other snorkel assembly into the fitting coming out of the top of the solenoid valve. Insert the end of the remaining length of 1/4" plastic hose into the straight fitting on the #2 port of the solenoid valve. Route this hose, both snorkel hoses and the blue wire on the solenoid valve up into the engine bay. The hose from solenoid valve will later be attached to the regulator assembly once that is installed. The two snorkels can be run through the firewall and secured under the dash area, away from any moving parts or major heat sources.

Air Compressor Mounting Installation

You will need to remove the inner front fender well on the passenger side of the vehicle. There are eight bolts holding the lining in place. If you can put the vehicle on a hoist about 3 feet above the ground it will ease this installation.

Locate the hood support bolt up inside the fender well; it is very close to the bottom of the radio antenna. Remove the bolt closest to the battery tray or closest to the front of the vehicle.

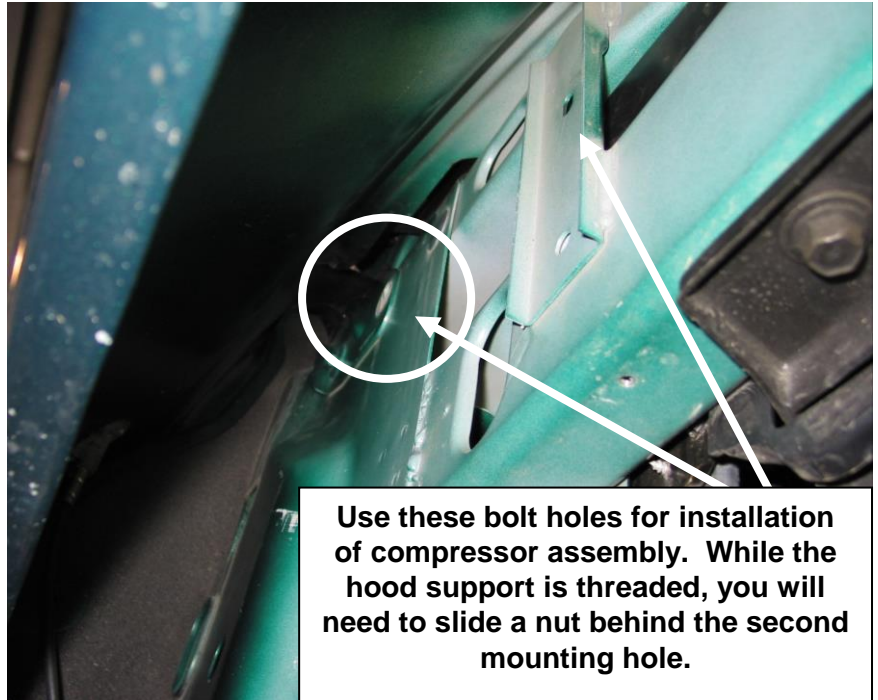

Attach the foam tape to the bottom backside of the bracket.

Slide the compressor assembly up into this space and re-install the hood support bolt. Now raise the compressor assembly so that you can install the provided bolt through the bracket and frame hole into the nut. Note that you can use a magnet to assist in holding this nut into place will you slide the bolt through.

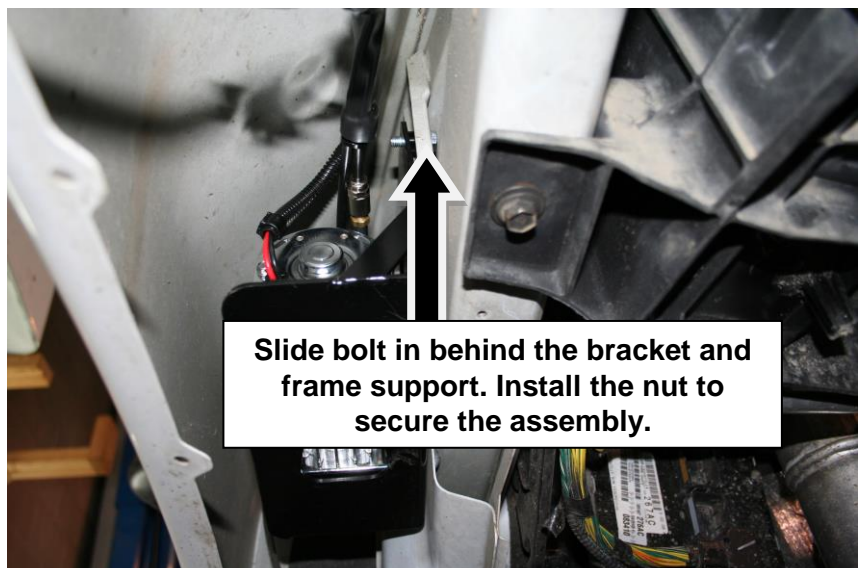
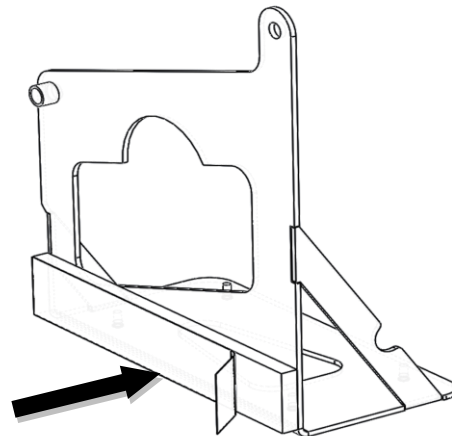

BD Engine Brake Inc.

Plant Address: 33541 MacLure Rd. Abbotsford, BC, Canada V2S 7W2

U.S. Shipping Address: 88-446 Harrison St, Sumas, WA 98295 U.S. Mailing Address: P.O. Box 231, Sumas, WA 98295

Phone: 604-853-6096 | Fax: 604-853-8749 | Internet: www.bd-power.com

Tighten all bolts and secure assembly. Route the compressor pigtail wiring harness up towards the regulator assembly you previously installed. You will also need to route a small section of plastic air hose from the quick connect of the air compressor outlet to the regulator assembly.

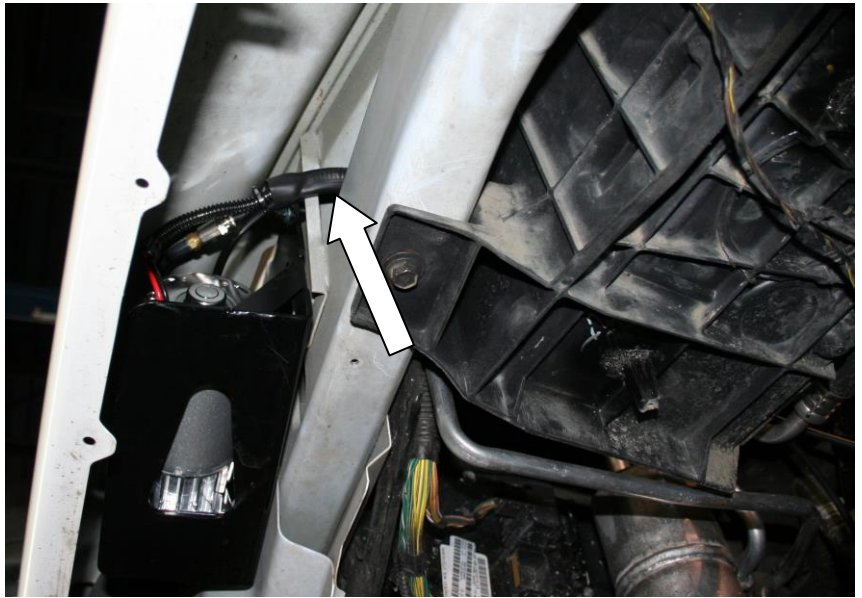

Use the wiring diagram on page 19 as a reference for the wiring of the air hoses and the electrical wiring. NOTE: Be sure to keep all hoses and wiring harnesses away from any moving parts or heat sources.

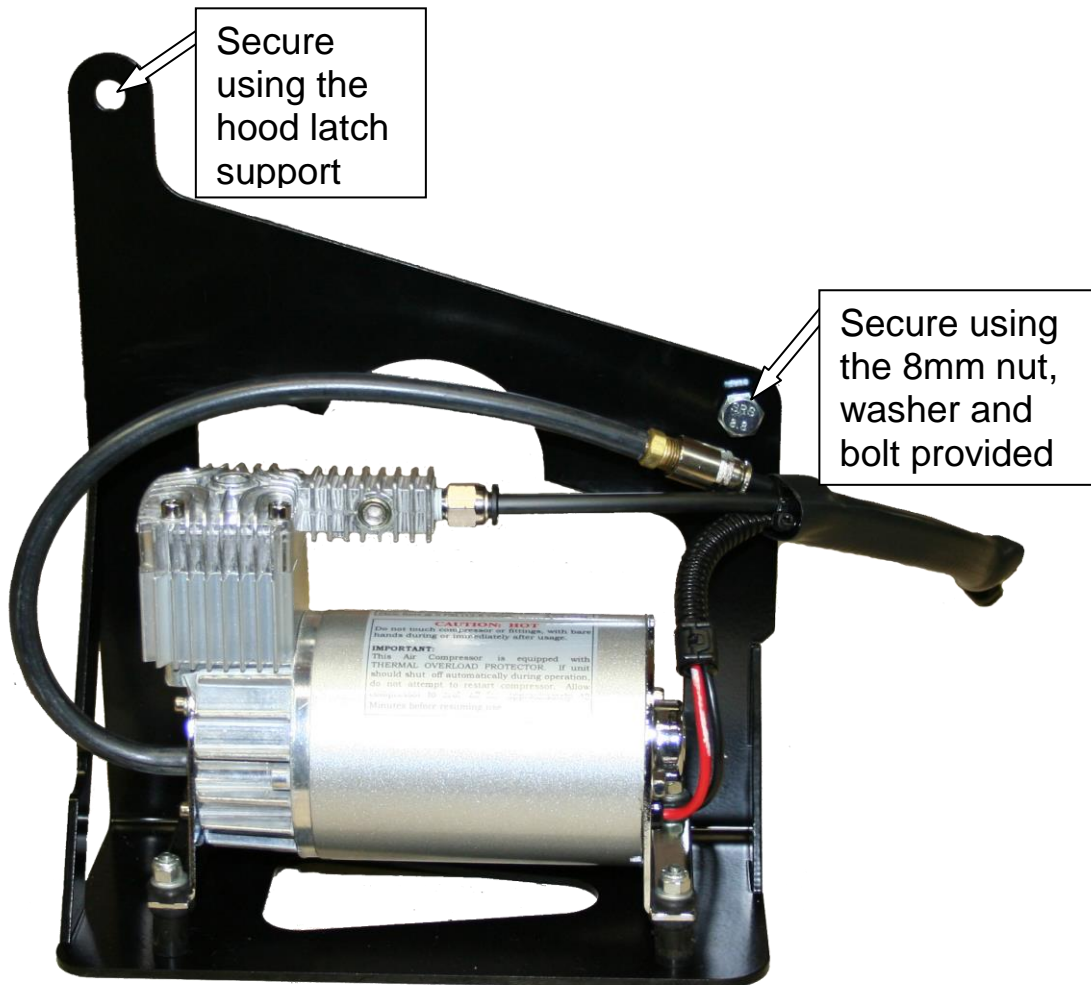

Compressor & Regulator Installation

Regulator Assembly

2007.5-09

Locate the large oval hole on the passenger side of the vehicle near the upper cowl of the firewall. To the right of this you can either drill a 3/8" hole or use the existing hole by removing the factory plastic locking insert.

2010-12

Remove the plastic locking insert (see diagram to right).

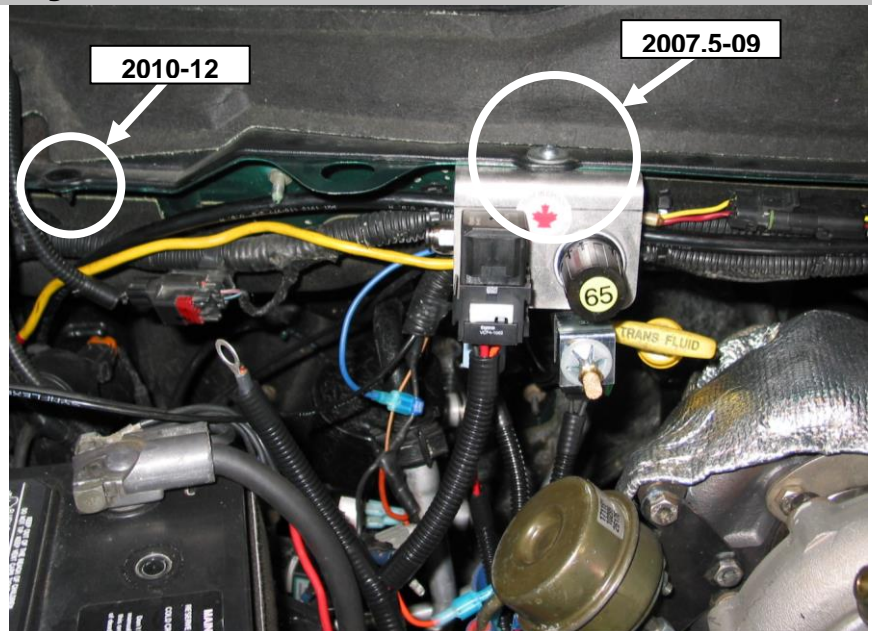

Install the regulator assembly underneath the hole (shown on figure to the right). The lock washer and flat washer should be installed on top of the plastic cowl with the Phillips screw holding everything in place.

DFIV INSTALLATION

Mount the DFIV module in a secure location under the dash using the cable ties provided. Route the pink wire from the “brake” terminal on the DFIV through the firewall (there is usually a factory grommet in the firewall that can be used for this). Crimp the pink DFIV wire to the pink wire from the regulator harness, using one of the provided crimp connectors with the clear heat shrink. Once this is done you can shrink the heat shrink to seal the connection.

Attach the black ground wire the “Gnd” terminal of the DFIV and connect the end with the ring terminal to a good ground.

Route the yellow wire from the APPS terminal of the DFIV over to the accelerator pedal position sensor located on the accelerator pedal. Install one of the supplied Posi-Taps onto the correct wire for your application (see chart below) and attach the yellow wire to it.

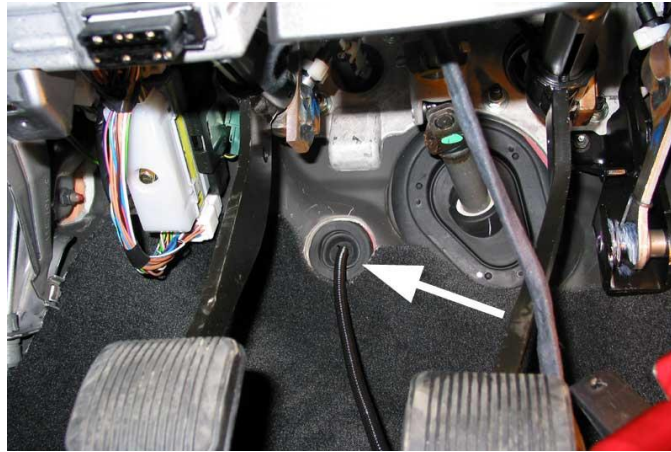

BD Engine Brake Inc.

Plant Address: 33541 MacLure Rd. Abbotsford, BC, Canada V2S 7W2

U.S. Shipping Address: 88-446 Harrison St, Sumas, WA 98295 U.S. Mailing Address: P.O. Box 231, Sumas, WA 98295

Phone: 604-853-6096 | Fax: 604-853-8749 | Internet: www.bd-power.com

Accelerator Pedal Position Sensor Wiring (2007.5-12)

Route the **yellow** wire from the DFIV module to the accelerator pedal position sensor located on the accelerator pedal. Install a Posi-Tap to the correct wire color for your application. The yellow DFIV wire should now be connected to the correct APPS wire.

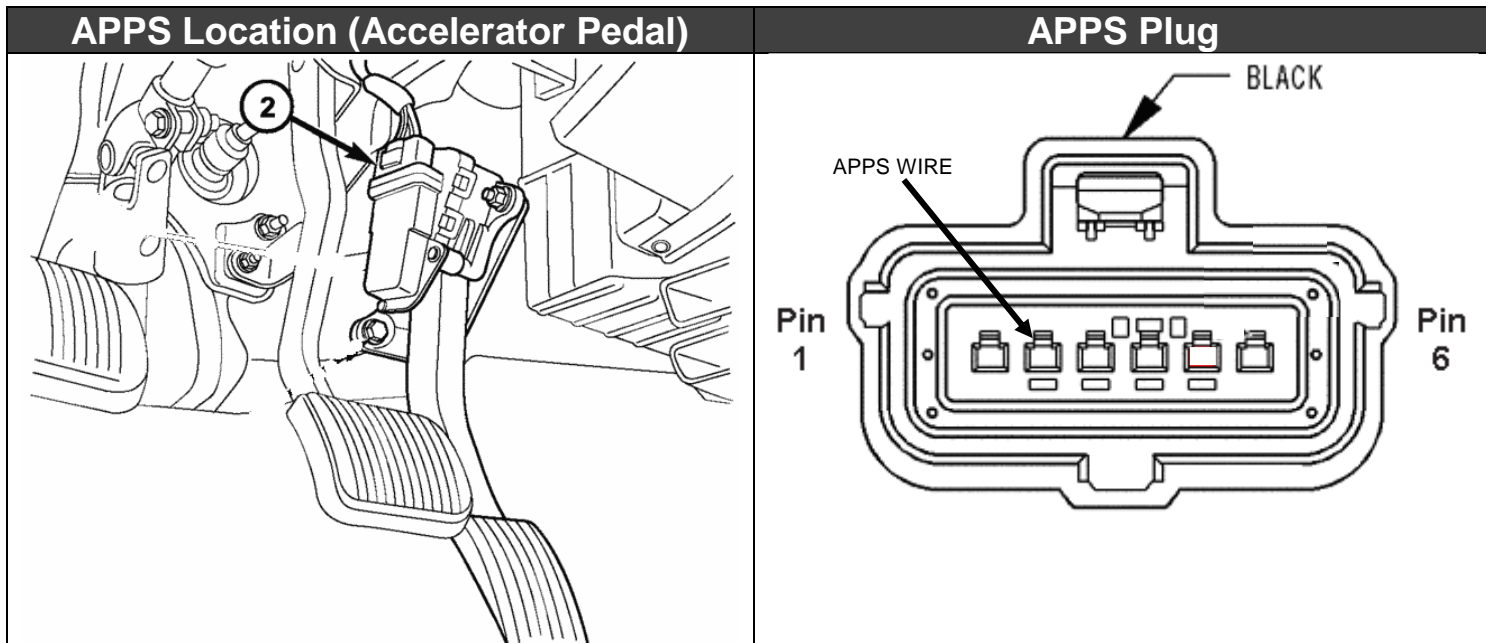

APPS CONNECTION			
Year	APPS Plug Pin	Circuit / Wire Color	Function
2007.5-2009	2	BN/WT	APPS NO. 1 SIGNAL
2010-2012	A2	BRN/LG	APPS 1 SIGNAL

Brake Switch wiring for Speed Control to DFIV

Insert the Green wire from the DFIV – Relay Kit (1321047) into the “brake” port on the DFIV with the Pink wire (pink wire should already be connected into the DFIV). Ground the Blue wire from the DFIV- Relay Kit to a good ground. Locate the brake pedal switch and cut the factory wire indicated in the chart below. Using the supplied crimp butt connectors crimp the red wire from the relay kit to the brake switch wire coming out of the brake switch connector. Then crimp the violet wire to the other end of the wire you just cut (wire that goes to the ECM).



Year	Pin	Wire Color
2007.5-2009	6	DG/WHT
2010 - 2012	A6	DG/RD

BD Engine Brake Inc.

Plant Address: 33541 MacLure Rd. Abbotsford, BC, Canada V2S 7W2

U.S. Shipping Address: 88-446 Harrison St, Sumas, WA 98295 U.S. Mailing Address: P.O. Box 231, Sumas, WA 98295

Phone: 604-853-6096 | Fax: 604-853-8749 | Internet: www.bd-power.com

Switch Install (Not required if using shifter-mounted switch)

Locate a suitable location to mount the switch in the dash.



Remove the three screws holding the insert into the dash; gently pull the insert toward you.

With the insert out place it on a large working surface like a table or work bench.

Measure and mark a spot for the Toggle Switch. Drill a pilot hole with a 1/8" bit and finish by enlarging the hole with a Unibit to exactly 1/2".



BD Engine Brake Inc.

Plant Address: 33541 MacLure Rd. Abbotsford, BC, Canada V2S 7W2

U.S. Shipping Address: 88-446 Harrison St, Sumas, WA 98295 U.S. Mailing Address: P.O. Box 231, Sumas, WA 98295

Phone: 604-853-6096 | Fax: 604-853-8749 | Internet: www.bd-power.com

Install switch into drilled hole and secure with lock ring then reinstall dash trim panels by reversing the removal procedure.

Once the switch is installed, attach the ground wire to a good metal ground under the dash.

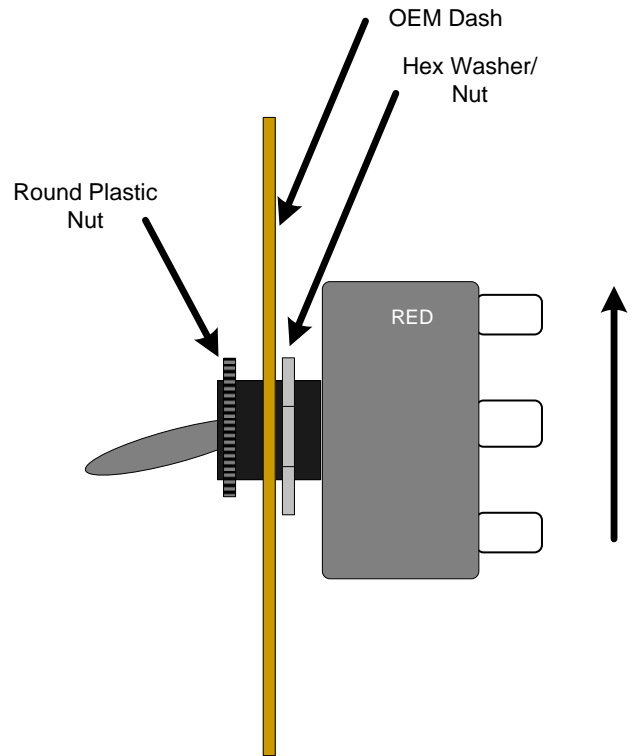

Run the Red wire from the toggle switch to the Totally Integrated Power Module (TIPM) located on the driver's side fender well and attach to the appropriate fuse using the supplied fuse tap. Connect the other Lt Green wire from the toggle switch to the "switch" terminal on the DFIV.



TIPM FUSE	
YEAR	FUSE
2007.5-2009	FUSE #30
2010	FUSE #M45
2011-2012	FUSE #M33

Optional Manual Shifter Switch (Push-Pull Style)

Mount the shifter switch onto the shift lever using the clamp supplied (either 5/8" or 3/4"). Run the electrical cable down the shifter shaft, securing the cable with zip-ties or electrical tape, and run it under the carpet to the firewall and under the dash to the DFIV, leaving enough slack for proper shifting of the transmission lever and to prevent any rubbing of wire.

At the end of the cable, cut off any excess and strip away about 1 to 2 inches of the black rubber covering to expose the black and white (or green) wires then strip the insulation from the ends of the two wires.



Connect the white (or green) wire to the "Switch" terminal on the DFIV.

Connect the black wire to a switched 12 volt power source as shown in the main wiring diagram. There is no need for a ground wire with the push-pull switch.

BD Engine Brake Inc.

Plant Address: 33541 MacLure Rd. Abbotsford, BC, Canada V2S 7W2

U.S. Shipping Address: 88-446 Harrison St, Sumas, WA 98295 U.S. Mailing Address: P.O. Box 231, Sumas, WA 98295

Phone: 604-853-6096 | Fax: 604-853-8749 | Internet: www.bd-power.com

Optional Manual Shifter Switch (Rocker Switch Style)

Mount the shifter switch onto the shift lever using the clamp supplied (either 5/8" or 3/4"). Run the electrical cable down the shifter shaft, securing the cable with zip-ties or electrical tape, and run it under the carpet to the firewall and under the dash to the DFIV, leaving enough slack for proper shifting of the transmission lever and to prevent any rubbing of wire.

At the end of the cable, cut off any excess and strip away about 1-2" of the black rubber insulation to expose the black, white and green wires, then strip the insulation from the ends of the three wires.

Connect the green wire to the "Switch" terminal on the DFIV.

Attach the 5/16" ring connector to the black ground wire and attach it to a good ground nearby.

Locate one of the ignition switched power fuses in the fuse panel. Use the supplied fuse tap to supply ignition switched power to the "Keyed 12 Volts" (white) wire of the rocker switch assembly.

Also provided in the kit is a Posi-Tap connector as an alternative to the fuse tap and flag connector. If you want to use the Posi-Tap instead of using the fuse tap in the fuse panel, then you will need to locate a 12V switched ignition wire to power the switch.

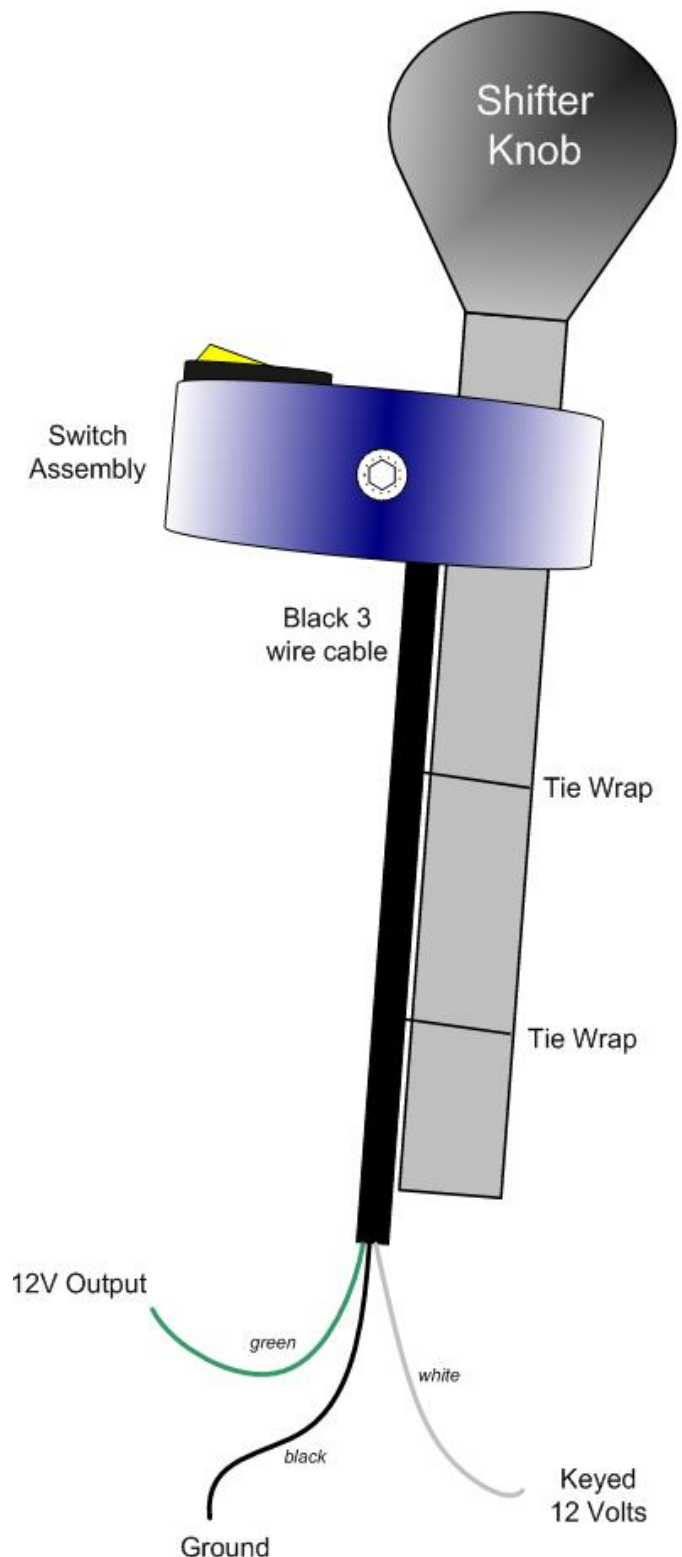

Wiring & Plumbing Diagram

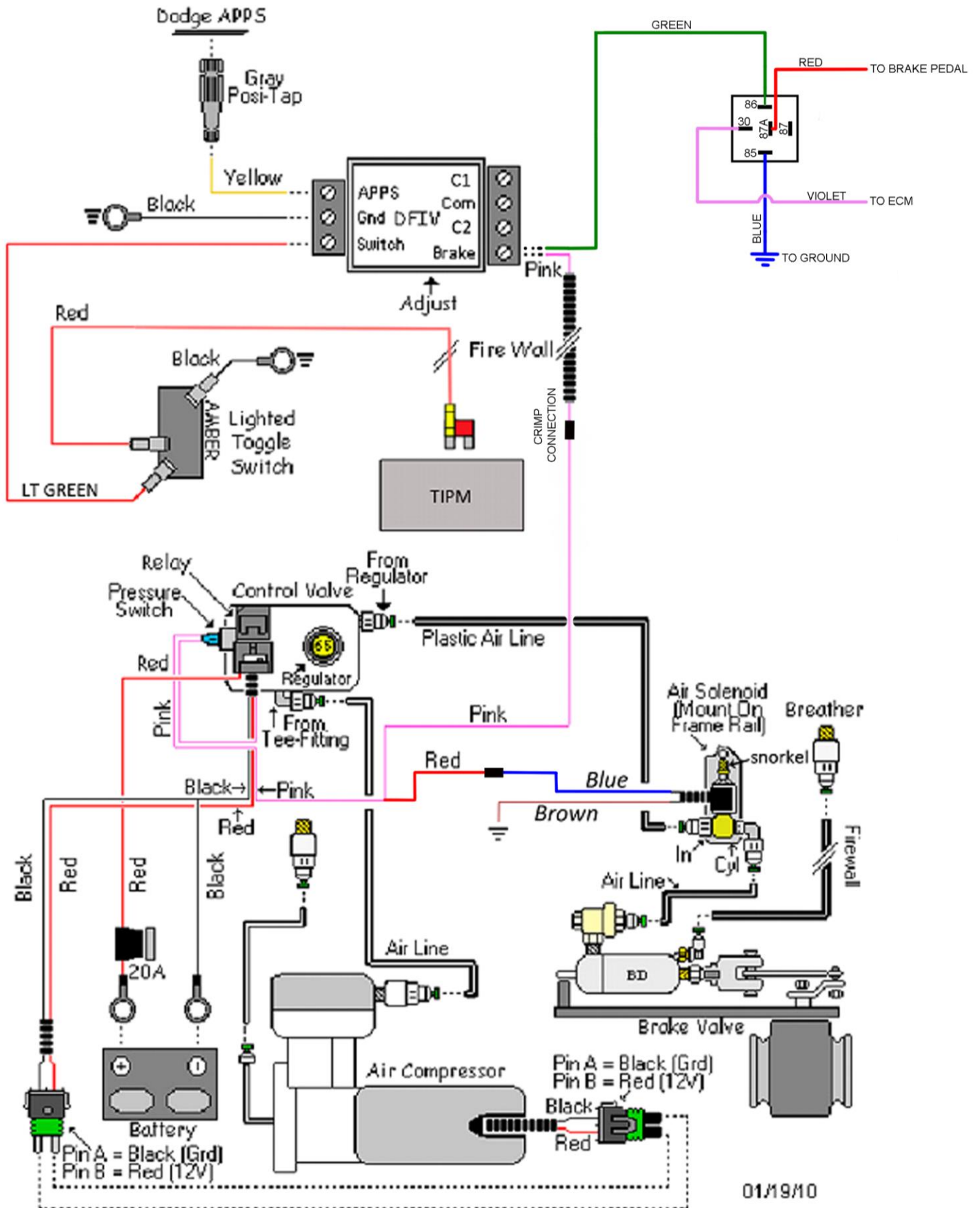

DFIV Adjustment & Testing

To achieve the correct setting for the activation of the exhaust brake in relation to the throttle pedal the DFIV Module must be calibrated for your vehicle.

Connect one end of a test light to the "BRAKE" terminal of the DFIV module and the other end to a good ground.

With the throttle at idle, turn the key to run and turn on toggle switch (switch should light up). Then, using a small flat bladed screwdriver, turn the small adjusting screw in the DFIV Module counterclockwise or clockwise until the test light JUST turns on.



CAUTION: THE ADJUSTING SCREW IS A MICRO-SWITCH THAT IS VERY DELICATE, SO TURN USING SMALL ADJUSTMENTS

As the accelerator pedal is applied the test light should turn off just as the throttle comes off idle, indicating proper calibration of the DFIV Module with the APPS. Then the test light should activate again when the throttle pedal returned to idle. If not, readjust the DFIV Module so that it does.

DFIV Operation

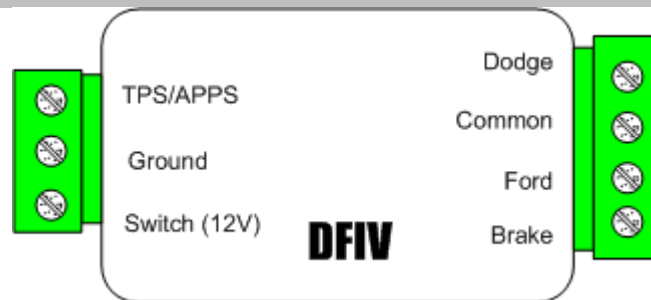

Input	Description
TPS/APPS	Locate the TPS/APPS wire from the Accelerator pedal position assembly. This wire is referred to as sensor circuit #1 on the rising signal circuit, and should rise linearly in voltage with the amount of throttle depressed. Typical values range from 0.5 Volts and rise to 4.5 Volts.
Ground	Connect to Vehicle electrical ground
Switch (12V)	This connection will supply 12 volt power to the DFIV. This will come from the toggle or shifter switch.
Dodge	This input should only be used for Dodge applications as it disables the cruise control specifically for Dodge trucks.
Common	Common cruise inputs between the Dodge and Ford inputs.
Ford	This input can be used for other generic applications. When the brake is activated the connection between the Ford input and the Common is severed.
Brake	You should have 12 volts at this terminal when the key is in "run", the brake switch is on and the throttle is at idle. There should be no power at this terminal if any of those conditions are not met.

Exhaust Back Pressure Testing Air Actuated Brakes

It is recommend that you purchase the BD pressure gauge kit #1030050



NOTE: The brake stop-bolt and regulator have been preset at the factory and should not need to be adjusted.

You do not need to measure the air pressure in the system, just the exhaust backpressure, which is located on the cast valve.



Idle Pressure Test

With the BD brake engaged and the engine at idle check the exhaust backpressure using a pressure gauge (such as BD PN 1030050) at the test port on the brake valve.

If the back pressure is below 13 psi at idle you have a number of likely causes. The most common being an exhaust leak either at the clamp joint or at the welds (only on some models). Apply the exhaust brake and have someone assist you looking for soot trails or the visible leak. Another culprit would be an exhaust manifold leak, turbocharger gasket leak, turbocharger problem or an EGR issue.

If the back pressure is greater than 25psi, you will need to make an adjustment on the stop bolt. Loosen the jam nut, and lengthen the stop bolt towards the actuator, this will shorten the stroke distance. Only turn 1/4 rotation at a time and re-secure the jam nut. Retest idle pressure.

We generally do not recommend adjusting the stop bolt, please consult BD before doing this as it may void your warranty.

Off-Idle Pressure Test & Adjustment

Your BD exhaust brake is a variable-orifice design so when the brake is active and the engine is at higher RPM the brake lever does not rest on the stop bolt. Off-idle backpressure is set by adjusting the air pressure regulator which will in turn increase or decrease off-idle exhaust backpressure. You will need to secure your pressure gauge somewhere that you can see it while you are driving. Using a long extension hose & bringing the gauge into the cab through an open window or clipping it under a windshield wiper works well.

Get the truck up to speed (a downhill grade or a load in the truck is helpful) and activate the exhaust brake. Note the maximum backpressure achieved. You should get peak backpressure at higher RPM (try 3000 RPM in Drive). If you cannot reach the desired backpressure (compare table below) you can begin troubleshooting, the first step is to look for exhaust leaks either from the clamps, exhaust manifolds or feed pipes. Also look for leaks at the clamps located at the back of the turbo and also at the down pipe. If all connections are sealed, you can then use the adjusting regulator to increase the backpressure. Note that small regulator adjustments can have a significant effect on off-idle backpressure.

Turning the regulator **clockwise** will increase pressure.

Turning the regulator **counter clockwise** will decrease pressure.



NOTE: Over the next two weeks, the backpressure at idle may rise due to initial carbon build up on the inside of the brake housing and on the butterfly. The stop bolt may need to be adjusted again to compensate.

Application	Maximum Back Pressure
GM/Chevy 6.5	35 psi
GM/Chevy Duramax	55 psi
Ford Powerstroke	45 psi
Dodge Cummins 1988-98 12V w/o 60lbs Springs	40 psi
Dodge Cummins 1988-98 12V with 60lbs Springs	60 psi
Dodge Cummins 1998 to current	60 psi

*HD Spring part# is 1030060.

CAUTION: Do NOT exceed the maximum back pressure value in the exhaust system. Exceeding this pressure will force the exhaust valves open during the intake stroke which could cause engine damage.

Maintenance

To extend life of the exhaust brake, do not operate the vehicle for extended periods of time without activating the brake. We suggest activating the exhaust brake at least a couple times a day while operating the vehicle to prevent any carbon or rust build up on inner parts of the brake valve assembly.

The hoses, wires, fittings and clamps should be inspected on a regular basis for any deterioration, damage or leaks.

To increase the life of your exhaust brake, we recommend daily operation. By simply switching the brake on and off a couple times a day, it will prevent the butterfly valve from sticking due to carbon build-up.

Following the diagrams in this manual, tracing hoses and wiring, checking continuity through electric components or checking for any lines that are disconnected, should solve any problems that may arise. If you have any problems or need replacement parts, call us at 1-800-887-5030, between 8:30am and 5:00pm Pacific Time.

Operating Guidelines

Thank you for taking interest in the BD Engine Exhaust Brake. As a driver, you probably already know the need for extra braking power that your vehicle requires on the hills and long grades. With loads being towed behind you, the extra push when slowing down or maintaining speed on downward grades can prove to be a great strain on your vehicles hydraulic braking system, even to the point of “burn-up”. These guidelines were designed to offer you a better understanding of the benefits of exhaust brakes and are partly based upon material developed by the U.S. Department of Transportation National Highway Traffic Safety Administration.

The emphasis on today’s vehicles is to give the consumer a product that can give them usable power with fuel efficiency. But, in the transition, the vehicles have lost their natural braking power, making it more easy for the vehicle to continue to roll and harder to stop. Of course, this gets more noticeable with the increase of weight, on or behind the vehicle. This is where an exhaust brake becomes a useful tool in increasing the driveline drag of the vehicle without the use of the hydraulic brakes; a tool that with maximum use or even occasional use can reduce wear on hydraulic braking parts and at the same time increase safety.

The BD Exhaust Brake can be used to help maintain a controlled vehicle speed on a downward grade, as well as slowing the vehicle down for such times as turns or exit ramps, without you using your hydraulic brakes. **But, the exhaust brake cannot be used as a parking brake will not bring your vehicle to a complete stop.** By using a BD Exhaust Brake, the life and effectiveness of your hydraulic brakes will increase.

BD Engine Brake Inc.

Plant Address: 33541 MacLure Rd. Abbotsford, BC, Canada V2S 7W2

U.S. Shipping Address: 88-446 Harrison St, Sumas, WA 98295 U.S. Mailing Address: P.O. Box 231, Sumas, WA 98295

Phone: 604-853-6096 | Fax: 604-853-8749 | Internet: www.bd-power.com

This is because of the decreased use of the hydraulic brakes in situations like hills, the wear factor is reduced and there is less opportunity for your hydraulic brakes to heat up which would reduce the efficiency. When you ride your hydraulic brakes, make hard stops or have poorly adjusted brakes, this creates high temperatures and as your brakes get hotter, the more chance there is for failure.

With terrain that is a series of up and down grades, the BD Exhaust Brake will help reduce warping in the exhaust valves. Because of the power needed to pull your vehicle and load up a hill, this generates a lot of heat. When you have reached the crest of the hill and are coasting down the other side, the heated valves are cooled too quickly. With the exhaust brake engaged, the heat loss to the valves will be reduced, which can prevent valve warping.

When the toggle switch is turned to the "On" position, the valve is activated every time the driver takes his foot off of the throttle pedal. When the driver puts pressure back on the throttle pedal, the DFIV/switch is deactivated and the valve opens again.

Exhaust brakes are designed to operate with the throttle at idle - not to be used in conjunction with cruise controls, and not designed to aid in gear shifting.

Such cases may cause damage to engine and/or exhaust brake. There is a pressure regulating system incorporated with the BD Exhaust Brake that will control the created backpressure. If the backpressure reaches the set limit while under engine braking, the exhaust valve will open slightly to relieve the excess pressure.

The best scenario for exhaust braking is when going down hill, select a gear that lets you maintain a constant speed with little or no use of the hydraulic brakes, or the same gear that would be used to go up the same grade of hill. This also depends on the weight, load or road conditions that the vehicle will come upon. So, in summary, by using the BD Exhaust Brake, you reduce the need for use of your hydraulic brakes in situations where you need to slow down or maintain speed (i.e. hills, off ramps, corners, approaching speed changes or traffic lights). Reducing the use of your hydraulic brakes in these situations will reduce the heat build up, as well as wear and damage to linings and drums. And, when you reduce these factors, you save your hydraulic brakes for when you really need them (for stopping or emergencies).

The BD Exhaust Brake is not a substitute for your hydraulic brakes and, cannot correct or compensate for poorly maintained or misadjusted brakes. But, when you need to slow down or maintain a constant speed, the BD Exhaust Brake will be a valuable and effective tool. Exhaust Brakes are more efficient at preventing rather than correcting an over speed condition.

Air Brake Troubleshooting Guide

This guide assumes that your exhaust brake system is using a DFIV and a BD air compressor. If your system uses a micro switch for throttle activation, the operation of the air solenoid and pump are the same as with the DFIV. If you are using existing on-board air, check that system as appropriate.

When I let off the throttle nothing happens.	<u>No</u>	<u>Yes</u>
<p>Is the DFIV powering its "brake" output when the throttle is at idle and brake switch and ignition are both on?</p>	<p>Check if DFIV has good power, ground and throttle signal. Check DFIV adjustment. If these things check out, but the DFIV won't power the "brake" output, the DFIV is likely faulty.</p> <p>Also check power & ground at pump relay and make sure the air solenoid has a good ground.</p>	<p>Check that when air solenoid is powered it will allow air to flow from the #2 port out the #1 port.</p> <p>Check that pump relay is powering pump. If pump has power but does not run, pump is likely faulty. Check for power & ground at pump relay, if these are good but relay does not click or does not power pump, relay is likely faulty.</p>
The brake comes on but there's little or no holdback	<u>No</u>	<u>Yes</u>
<p>See if torque converter is staying locked up during deceleration. If not, the engine RPM will fall to idle when the throttle is released. The brake will be ineffective without the torque converter locked up.</p> <p>Check off idle brake pressure. (See back pressure chart) Are you getting maximum allowable backpressure?</p>	<p>Check for exhaust leaks. A small leak can result in a significant decrease in back pressure. If no leaks are found try adjusting air regulator. Check for air leaks in brake system.</p>	<p>Try down shifting more aggressively. More RPM will give more holdback. Transmission or torque converter could be slipping internally.</p>
Everything seems to work, but the brake valve won't close.	<u>No</u>	<u>Yes</u>
<p>Check that air is reaching brake air cylinder?</p>	<p>Air solenoid or quick release valve are likely stuck, plugged or faulty. Clean or replace as required.</p>	<p>Cylinder or brake valve are seized. Remove the clevis pin on the end of the cylinder rod & see if the valve lever can be moved freely.</p>
<p>The valve lever can be moved freely?</p>	<p>Try dismounting the brake & cleaning the carbon out of it. If this does not work the brake valve will need to be replaced.</p>	<p>The cylinder is stuck and will need to be replaced.</p>
Problem	Solution	
<p>Air compressor runs in short bursts and brake is slow to apply.</p>	<p>There is a restriction in the air system, normally in the regulator or air solenoid. Remove the fittings from the regulator and air solenoid, you will likely find some corrosion or debris caught in them. Clean this out with a pick, small brush, compressed air and WD40 or similar lubricant.</p>	
<p>Air compressor runs continually.</p>	<p>Pump relay is likely stuck on. Check operation of relay & replace as required.</p>	
<p>Brake is slow to release.</p>	<p>Debris or corrosion is restricting the quick release valve or air solenoid. Clean as required. Air solenoid could be too far from brake.</p>	

Thank you and happy motoring.
BD Engine Brake, Inc.