





Lower Dodge Control Arms

1994-1999 4wd 2500/3500	1032030-L
2000-2009 4wd 2500/3500	1032031-L
2010-2012 4wd 2500/3500	1032032-L

PLEASE READ ALL INSTRUCTIONS BEFORE INSTALLATION

KIT CONTENTS:

Please check to make sure that you have all the parts listed in this kit **before** you start the disassembly of your truck.

Kit # 1032030-L					
1303206	1303221-RH	1303221-LH	1303206-5	1303225-5	1302072
					
<i>Control Arm-Center</i>	<i>Rod End (RHT)</i>	<i>Rod End (LHT)</i>	<i>Bushing Lower Control Arm</i>	<i>Sleeve (1.0 x .562x2.625)</i>	<i>Jam Nut 1"-14 (LHT)</i>
Qty: 2	Qty: 2	Qty: 2	Qty: 8	Qty: 4	Qty: 2
1302071	9.11108				
					
<i>Nut Jam 1"-14</i>	<i>Silicone Grease</i>				
Qty: 2	Qty: 2				

BD Engine Brake Inc.

Plant Address: 33541 MacLure Rd. Abbotsford, BC, Canada V2S 7W2

U.S. Shipping Address: 88-446 Harrison St, Sumas, WA 98295 U.S. Mailing Address: P.O. Box 231, Sumas, WA 98295

Phone: 604-853-6096 | Fax: 604-853-8749 | Internet: www.bd-power.com

Kit # 1032031-L					
1303206	1303221-RH	1303221-LH	1303206-5	1303225-2	1302072
					
<i>Control Arm-Center</i>	<i>Rod End (RHT)</i>	<i>Rod End (LHT)</i>	<i>Bushing Lower Control Arm</i>	<i>Sleeve (1.0 x .688x2.625)</i>	<i>Jam Nut 1"-14 (LHT)</i>
Qty: 2	Qty: 2	Qty: 2	Qty: 8	Qty: 4	Qty: 2

1302071	9.11108
	
<i>Nut Jam 1"-14</i>	<i>Silicone Grease</i>
Qty: 2	Qty: 2

Kit # 1032032-L					
1303206	1303221-RH	1303221-LH	1303206-5	1303225-1	1302072
					
<i>Control Arm-Center</i>	<i>Rod End (RHT)</i>	<i>Rod End (LHT)</i>	<i>Bushing Lower Control Arm</i>	<i>Sleeve (1.0 x .732x2.625)</i>	<i>Jam Nut 1"-14 (LHT)</i>
Qty: 2	Qty: 2	Qty: 2	Qty: 8	Qty: 2	Qty: 2
1303225-2	1302071	9.11108			
					
<i>Sleeve (1.0 x .688x2.625)</i>	<i>Nut Jam 1"-2</i>	<i>Silicone Grease</i>			
Qty: 2	Qty: 4	Qty: 2			

Welcome

Thank you for purchasing a BD Control Arm Kit. Installation should occur on a vehicle that is properly supported to prevent rolling or movement.

Required Tools

- 1 1/2" Wrench
- 1 9/16" Wrench
- Mallet
- Metric Impact Socket Set
- Torque Wrench
- 1 1/2" Crow Foot
- Pry Bar
- Air Impact

Identification of Parts

It is critical that you can identify the key pieces in the kit as it will simplify installation. All the model year kits are the same except for the sleeves. The mounting bolt diameters change throughout the years.

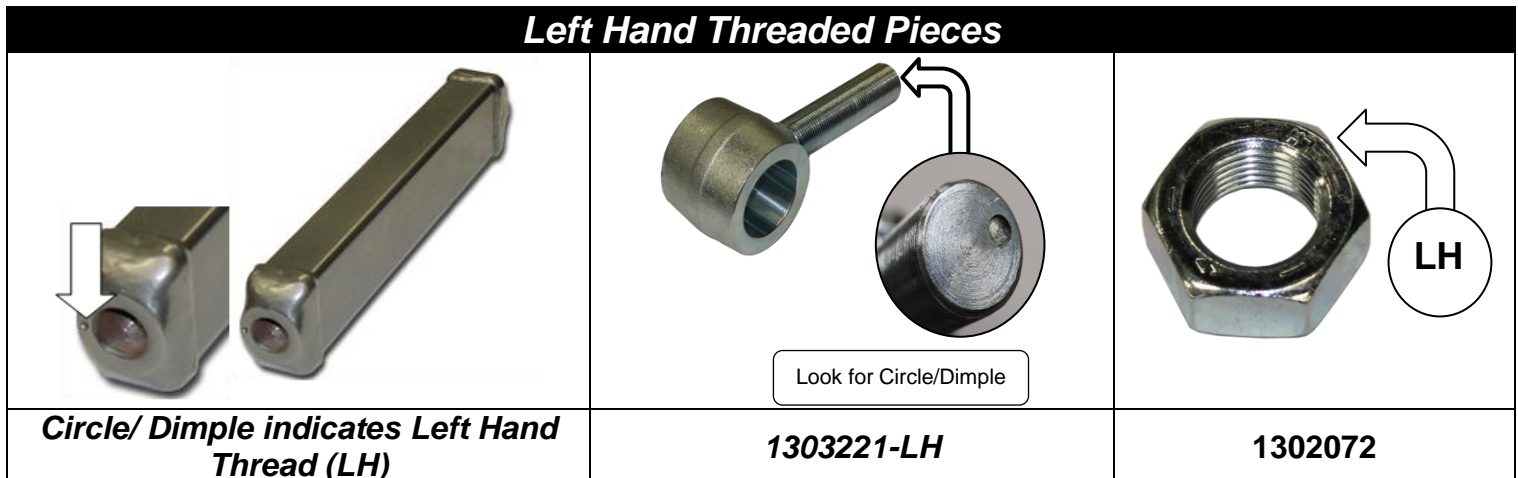
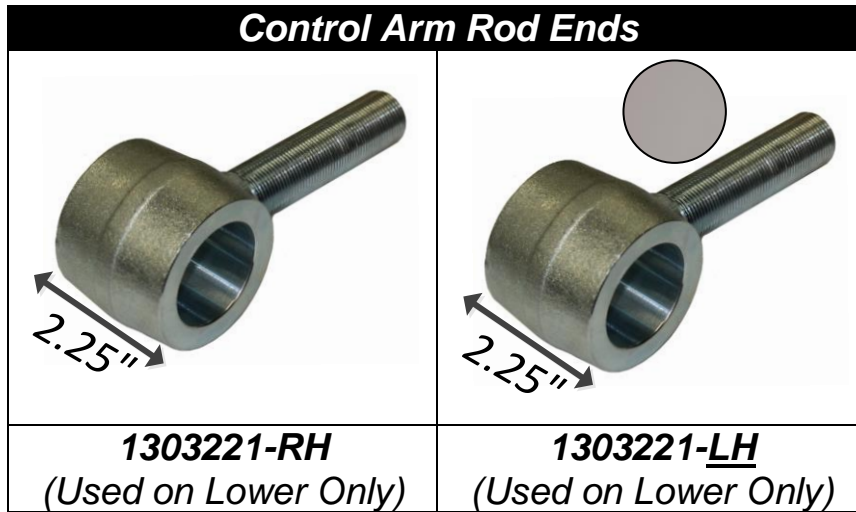



**VEHICLE SHOULD BE SAFELY SECURED BEFORE INSTALLATION.
THIS CONTROL ARM SHOULD BE INSTALLED AT A SHOP THAT CAN PERFORM
A FRONT END ALIGNMENT**

1. Lift vehicle and support from frame letting the front axle hang at full droop.
2. Remove front wheels.

3. Loosen and remove lower control arm bolts then remove control arm from one side.



4. Axle will have to be pulled forward slightly to allow sufficient clearance for removal. (Passenger side frame bolt requires removal of the exhaust down pipe for clearance.)

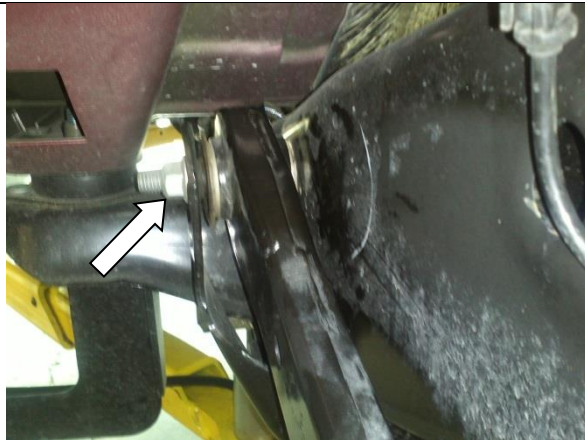

5. Assemble BD adjustable control arm components as illustrated in diagrams. Insert the correct sleeves into the correct locations. Please see the below table for reference.
Lubricate the polyurethane bushings and sleeves with the supplied silicone grease. Use one bag per bar.

BD Engine Brake Inc.

Plant Address: 33541 MacLure Rd. Abbotsford, BC, Canada V2S 7W2

U.S. Shipping Address: 88-446 Harrison St, Sumas, WA 98295 U.S. Mailing Address: P.O. Box 231, Sumas, WA 98295

Phone: 604-853-6096 | Fax: 604-853-8749 | Internet: www.bd-power.com

Lower Control Arm (Double Threaded)

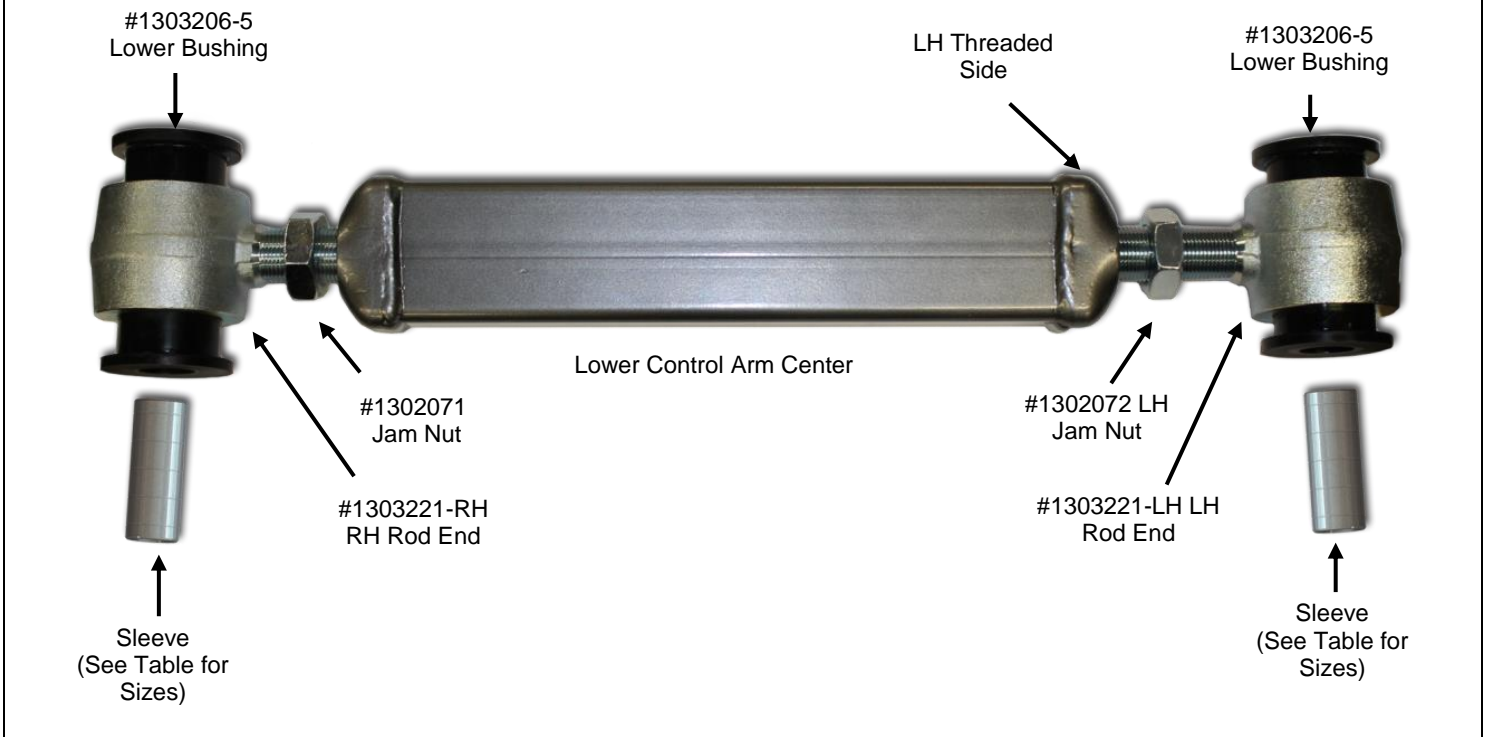

Polyurethane Sleeve Application Matrix

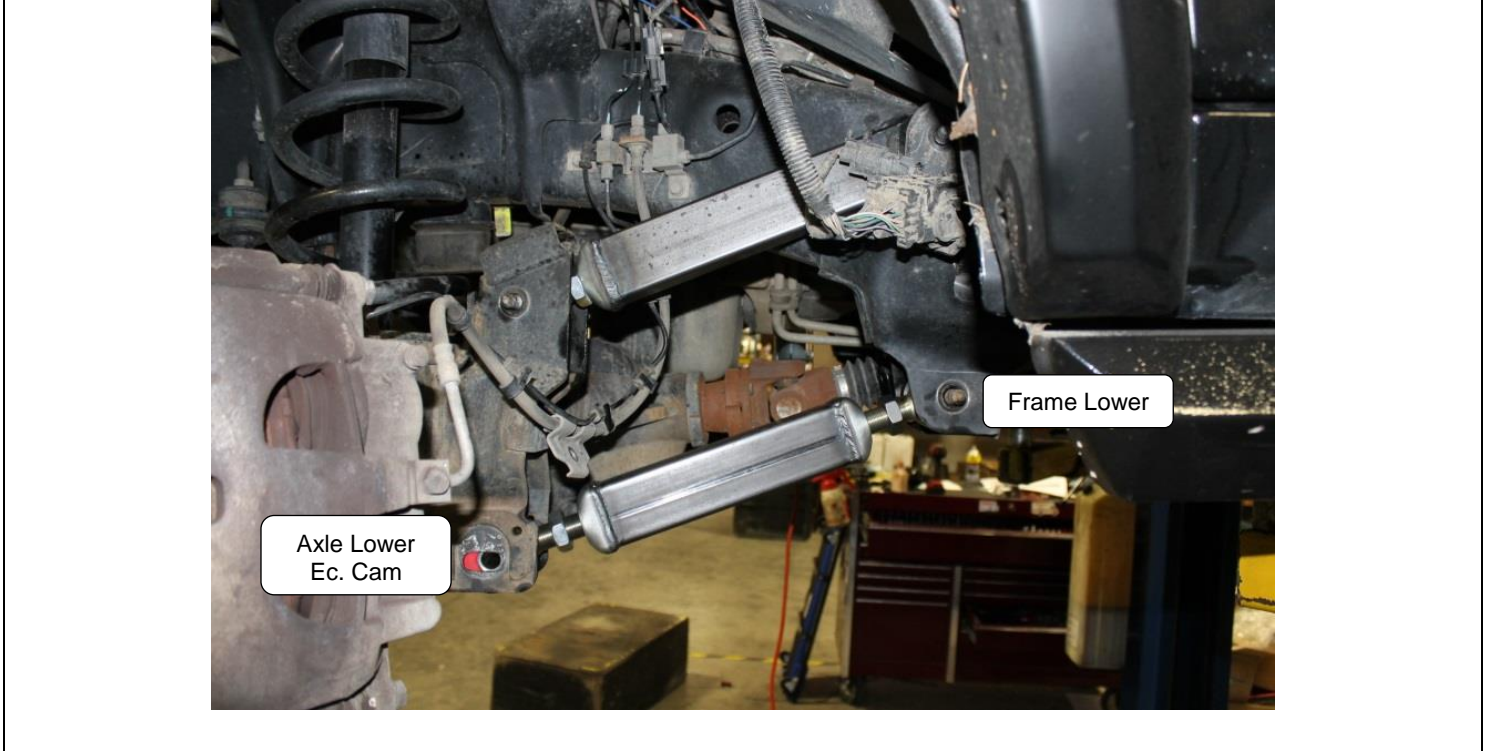

Lower		
Model Year	Lower Frame Mount	Lower Axle Mount (Ec. Cam)
1994-1999 <i>(Kit# 1032030)</i>	1303225-5 <i>(1.0 x .562x2.625)</i>	1303225-5 <i>(1.0 x .562x2.625)</i>
2000-2009 <i>(Kit# 1032031)</i>	1303225-2 <i>(1.0 x .688x2.625)</i>	1303225-2 <i>(1.0 x .688x2.625)</i>
2010-2012 <i>(Kit# 1032032)</i>	1303225-2 <i>(1.0 x .688x2.625)</i>	1303225-1 <i>(1.0 x .732x2.625)</i>

A quick identification of the sleeve is the number of “Bands” or “Rings” on them.
4 rings indicate a 130225-4 part.



6. Measure OE control arms center to center of mounting points and adjust BD control arms to same measurement for starting position as illustrated.
Lengthen to desired position now or have an alignment shop adjust after installation.

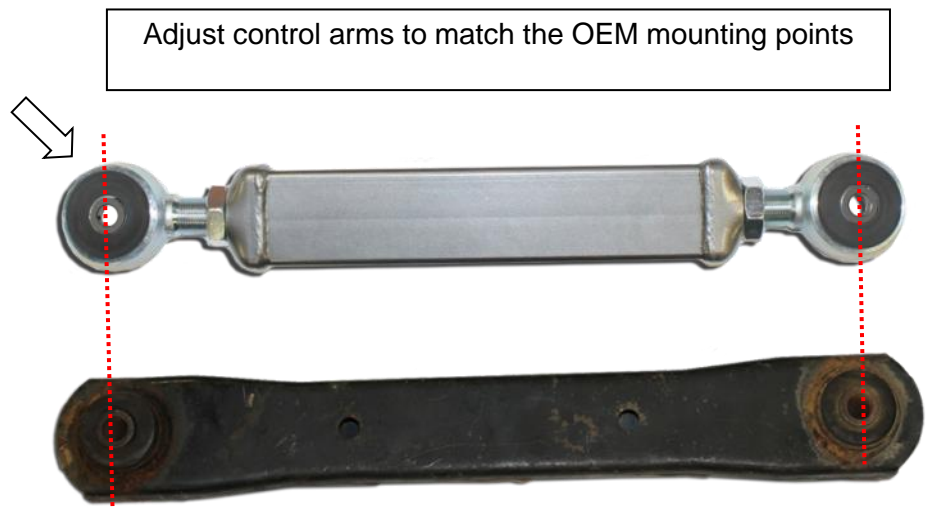

7. Install lower control arm. Torque upper and lower control arm bolts. Refer to table at rear of manual for correct torque for vehicle year.



For the lower control arm, when re-installing the eccentric cams, set them to neutral or vertical.

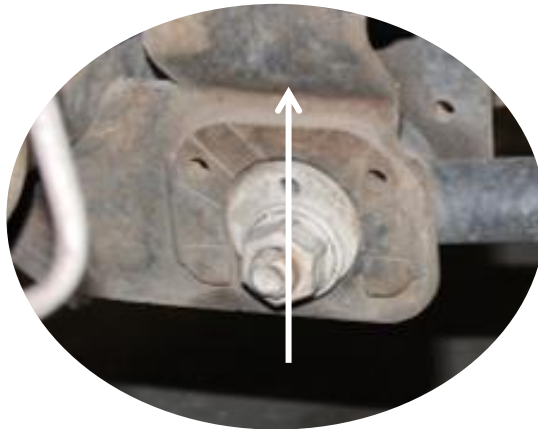

8. Tighten control arm jam nuts. Torque to 120 Ft. Lbs.



9. Repeat steps 3 – 9 for next side of vehicle.

10. Reinstall wheels, torque to specifications and lower vehicle.

11. **An alignment is needed after completion of installation. BD recommends between 4.5-5.5° of castor.** **BD**

BD Engine Brake Inc.

Plant Address: 33541 MacLure Rd. Abbotsford, BC, Canada V2S 7W2

U.S. Shipping Address: 88-446 Harrison St, Sumas, WA 98295 U.S. Mailing Address: P.O. Box 231, Sumas, WA 98295

Phone: 604-853-6096 | Fax: 604-853-8749 | Internet: www.bd-power.com

Torque Specifications

1994-1996		1997-1999	
Location	Ft Lbs	Location	Ft Lbs
Lower Axle Side	170	Lower Axle Side	95
Lower Frame Side	170	Lower Frame Side	125
2000-2002		2003-2005	
Location	Ft Lbs	Location	Ft Lbs
Lower Axle Side	140	Lower Axle Side	160
Lower Frame Side	140	Lower Frame Side	160
2006-2009		2010-2012	
Location	Ft Lbs	Location	Ft Lbs
Lower Axle Side	140	Lower Axle Side	200
Lower Frame Side	170	Lower Frame Side	200

If you have any technical difficulties, concerns, comments, or complaints, please phone our Technical Support hotline at (800) 887-5030 between 8:30am-5:00pm PST (Pacific Standard Time) Monday to Friday, or post a message on the BD Discussion Forums located at:

<http://forum.bd-power.com/>



Visit our Internet forums at <http://www.dieselpower.com> and share your comments or technical support questions with some of the industry's leading experts in the diesel field.