



X Flow Intake Manifold

For 2003-04 Ford 6.0L F-Series Trucks

Part #	Application	Description
1041570	Ford 6.0L 2003-04	Intake Horn (Black Powder Coat)
1041570P	Ford 6.0L 2003-04	Intake Horn (Polished)

-- Installation Instructions --

PLEASE READ ALL INSTRUCTIONS CAREFULLY BEFORE INSTALLATION.

UNLESS AN EO# IS LISTED, THIS PRODUCT IS LEGAL IN CALIFORNIA FOR RACING VEHICLES ONLY, WHICH MAY NEVER BE USED UPON A HIGHWAY.









BD Engine Brake Inc.

Plant Address: Unit A10, 33733 King Rd, Abbotsford, BC, Canada V2S 7M9

U.S. Shipping Address: 88-446 Harrison St, Sumas, WA 98295 U.S. Mailing Address: P.O. Box 231, Sumas, WA 98295

Phone: 604-853-6096 Fax: 604-853-8749 Internet: www.bd-power.com

Kit Contents

1041570 & 1041570P X-Intake Manifold			
1401570P	1401570-POL	1401581Z	1401582Z
			
<i>Powder Coated Intake (1041570 ONLY)</i>	<i>Polished Intake Horn (1041570-P ONLY)</i>	<i>Long Stud</i>	<i>Short Stud</i>
Qty: 1	Qty: 1	Qty: 1	Qty: 3
1453802	1401574	1401575	1405212
			
<i>Jam Nut</i>	<i>M6 Acorn Nut</i>	<i>M6 Washer</i>	<i>3.78" Spring Clamp</i>
Qty: 1	Qty: 4	Qty: 4	Qty: 1
1200208	1401577		
			
<i>1/8" NPT Plug</i>	<i>3-3.5" Boot</i>		
Qty: 1	Qty: 1		

BD Engine Brake Inc.

Plant Address: Unit A10, 33733 King Rd, Abbotsford, BC, Canada V2S 7M9

U.S. Shipping Address: 88-446 Harrison St, Sumas, WA 98295 U.S. Mailing Address: P.O. Box 231, Sumas, WA 98295

Phone: 604-853-6096 Fax: 604-853-8749 Internet: www.bd-power.com

Installation

Remove the factory intake elbow using a 10mm socket, as well remove the silicon boot and hose clamp with a 7/16" wrench.

You will need to save one of the 3" spring band clamps to reuse later on.

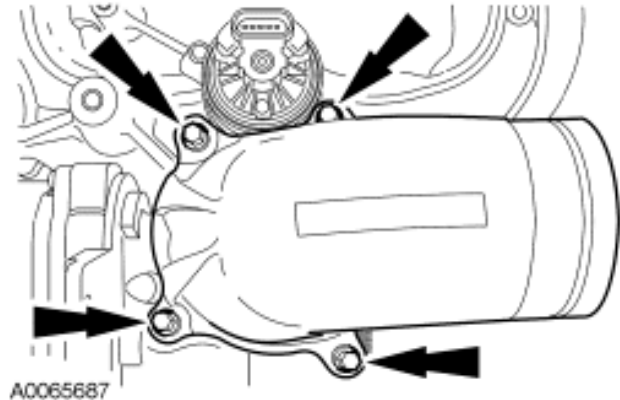

Attached to the bottom of the factory intake elbow will be a rectangular rubber seal. Store this in a safe place as it will be reused later.

Thread the four studs into the intake plenum. Note that the ends with the least amount of threads should be threaded into the intake plenum.

Take note that there should be one longer stud, this stud should be used for the passenger side rear location. This stud has a small diameter section to clear the mixing valve.

You should use some form of thread sealant on all the bottom threads of the studs.

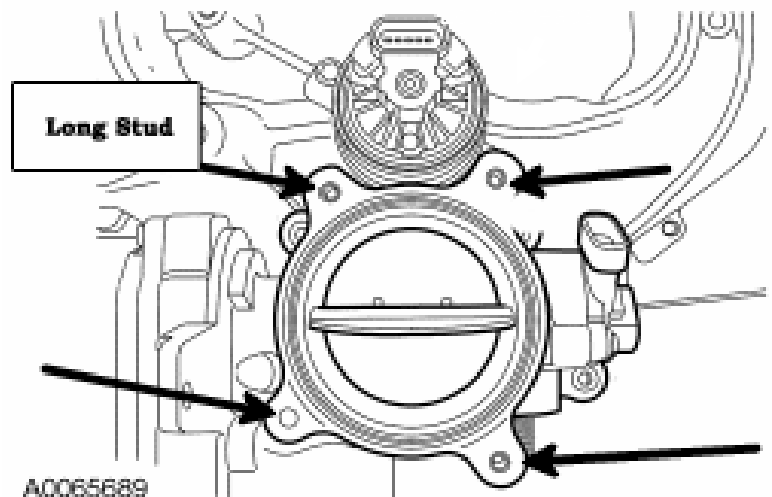

The long threads of the studs should be up.

BD Engine Brake Inc.

Plant Address: Unit A10, 33733 King Rd, Abbotsford, BC, Canada V2S 7M9

U.S. Shipping Address: 88-446 Harrison St, Sumas, WA 98295 U.S. Mailing Address: P.O. Box 231, Sumas, WA 98295

Phone: 604-853-6096 Fax: 604-853-8749 Internet: www.bd-power.com

With the Jam nut provided, double nut the studs and torque them into the intake plenum to 2 ft-lbs. This ensures that the stud is correctly bottomed.

You will need to use two wrenches to secure the two nuts together. And to release the jam not after the stud is tightened.

When inserting the intake manifold over the studs, be sure that the factory O-Ring stays seated.

Flip the BD Intake over and insert the intake over and down through the studs until it is mounted to the factory intake plenum.

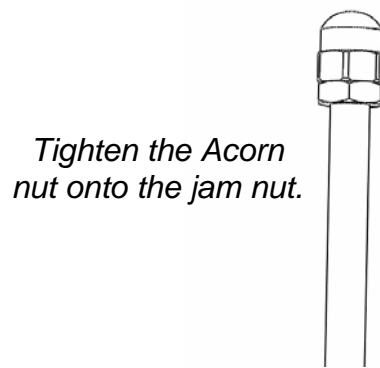

Install the flat M6 washers on all the studs.

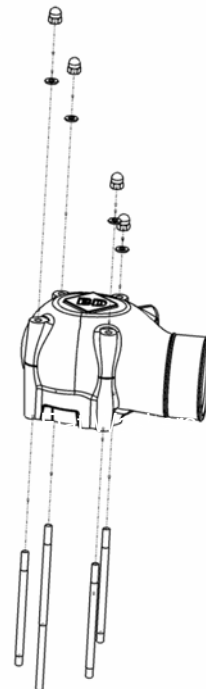

Insert the 4 M6 Acorn nuts onto the studs and torque to **8 ft-lbs (96 in-lbs)**.

BD Engine Brake Inc.

Plant Address: Unit A10, 33733 King Rd, Abbotsford, BC, Canada V2S 7M9

U.S. Shipping Address: 88-446 Harrison St, Sumas, WA 98295 U.S. Mailing Address: P.O. Box 231, Sumas, WA 98295

Phone: 604-853-6096 Fax: 604-853-8749 Internet: www.bd-power.com

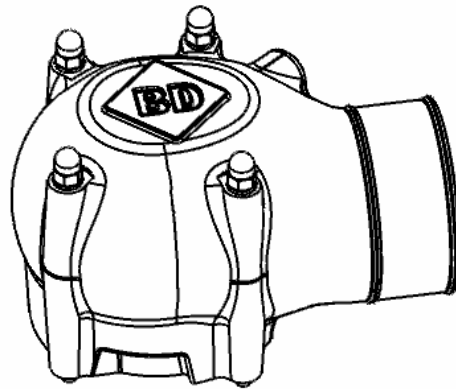

If you are not going to install a boost line into the 1/8th NPT port you will need to use the supplied plug to seal the hole. Be sure to use pipe sealant when using the plug.

Insert the 4-ply 3-3.25" silicone boot over the intake and onto the factory steel intercooler pipe. Use the supplied spring band clamp to secure the boot to the BD intake. You will re-use the factory 3" Ford clamp on the other side of the boot.

BD Engine Brake Inc.

Plant Address: Unit A10, 33733 King Rd, Abbotsford, BC, Canada V2S 7M9

U.S. Shipping Address: 88-446 Harrison St, Sumas, WA 98295 U.S. Mailing Address: P.O. Box 231, Sumas, WA 98295

Phone: 604-853-6096 Fax: 604-853-8749 Internet: www.bd-power.com