



Low stall convertors are not recommended for this turbocharger kit.



BD FORD 6.0L TURBOCHARGER KIT

P/N#	Application	Description
1047070	2003-07 Ford 6.0L	Turbo Kit Only w/SCT Tuner
1047071	2003-07 Ford 6.0L	Turbo Kit Only (No drivability guarantee)

**** PLEASE READ ALL INSTRUCTIONS BEFORE INSTALLATION ****

UNLESS AN EO# IS LISTED, THIS PRODUCT IS LEGAL IN CALIFORNIA FOR RACING VEHICLES ONLY, WHICH MAY NEVER BE USED UPON A HIGHWAY.

BD Engine Brake Inc.











Plant Address: 33541 MacLure Rd. Abbotsford, BC, Canada V2S 7W2

U.S. Shipping Address: 88-446 Harrison St, Sumas, WA 98295 U.S. Mailing Address: P.O. Box 231, Sumas, WA 98295

Phone: 604-853-6096 | Fax: 604-853-8749 | Internet: www.bd-power.com

K I T C O N T E N T S :

Please check to make sure that you have all the parts listed in this kit **before** you start the disassembly of your truck.

1407060-2	1407072Z	1407062	1407063
			
<i>Ford 6L Turbo Assembly</i>	<i>05-07 Oil Line Adapter</i>	<i>Turbo Oil Supply Fitting 03-04</i>	<i>Turbo Oil Supply Line</i>
Qty: 1	Qty: 1	Qty: 1	Qty: 1
1407071	1407078	1130182	1130184
			
<i>Oil Line Clamp</i>	<i>Oil Line O-Ring (1/2\" data-bbox="324 498 511 529"/></i>	<i>M6-1.0 x 16mm Bolt</i>	<i>M6 Flat Washer</i>
Qty: 1	Qty: 1	Qty: 2	Qty: 2
1407088	1400283	1407077	
			
<i>Heat Shield</i>	<i>O-Ring Oil Drain (3/4\" data-bbox="421 773 551 804"/></i>	<i>Oil Drain Tube</i>	
Qty: 1	Qty: 1	Qty: 1	

1407087	1407006	1407074	1452225
			
<i>Solenoid Holder</i>	<i>Comp. Outlet Boot</i>	<i>Compressor Outlet Adapter</i>	<i>Compressor Outlet Clamp</i>
Qty: 1	Qty: 1	Qty: 1	Qty: 1
1604102	1030099	1453113	1453251
			
<i>M8 Lock Washer</i>	<i>M8-1.25x25 Bolt</i>	<i>Gear Clamp</i>	<i>Turbo Outlet O-Ring (61mm x 3mm)</i>
Qty: 2	Qty: 2	Qty: 1	Qty:

TURBO HEAT SHIELD KIT (BD# 1459110)		
1459111	1459112	1459113
		
<i>Heater Wrap</i>	<i>Inner Wrap</i>	<i>S/S Wire</i>
Qty: 1	Qty: 1	Qty: 48"

1047070 Kit Only

1504770-SCT Tuning Kit
Qty: 1

PRE-INSTALLATION

A turbocharger is driven solely on exhaust energy. Therefore, if the vehicles current exhaust manifold is cracked or is leaking, it is recommended that the exhaust manifolds are decked by a reputable machine shop.

Installation should occur on a cold vehicle, as turbo and exhaust components become very hot with use.

The BD turbo system is recommended for trucks with 400-475 RWHP with a maximum efficient boost pressure of 45psi. For optimum performance, the turbo should operate between 30–40psi.

Always check for boost leaks, the intake manifold and EGR system is known to have leaks.

It is recommended that you install head studs before the turbo kit. By lifting the cab, the head stud and turbo install will be much easier.

UPGRADE OPTIONS

<u>Description</u>	<u>Part #</u>
BD Transmission	CALL
BD X2 Digital Gauge Monitor	1080500
BD Cool Down Timer 2	1081160
ARP HD Head Studs	250-4202
EGR Cooler Delete	1090001

TABLE OF CONTENTS

Pre-Installation.....4

Upgrade Options.....4

Table of Contents4

Battery Disconnect.....5

Removal of factory turbo and components.....5

Installation of bd turbo and components9

 CAB ON INSTALLATION9

Installation with the cab-off21

PCM programs.....30

BATTERY DISCONNECT

Record all radio station presets and settings (if desired). Disconnect the negative terminals on both of the vehicle's batteries, and then disconnect the positive terminals.

REMOVAL OF FACTORY TURBO AND COMPONENTS

Remove the push pins.

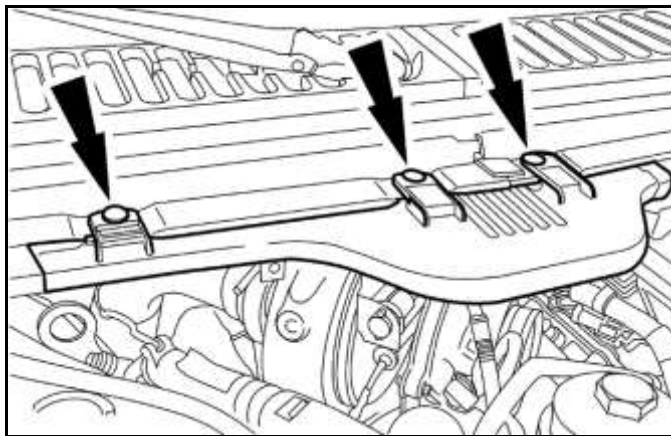

Disconnect the 2 wiring harness push pins and position them aside.

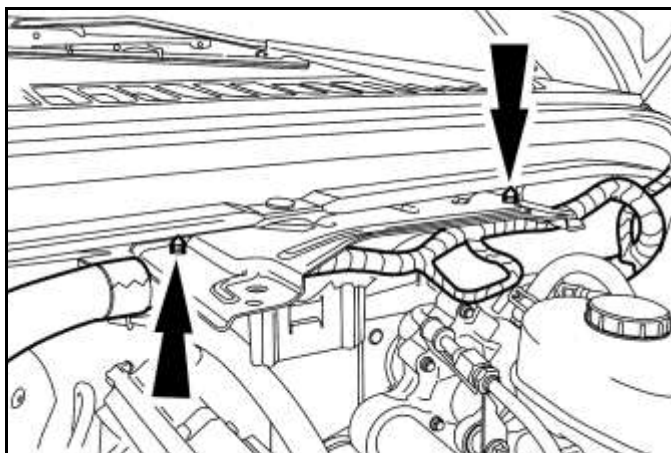

Loosen the gear clamp at the turbocharger inlet (8mm).

Remove the turbocharger intake tube.

Remove 2 (8mm) bolts securing tube to the support bracket.

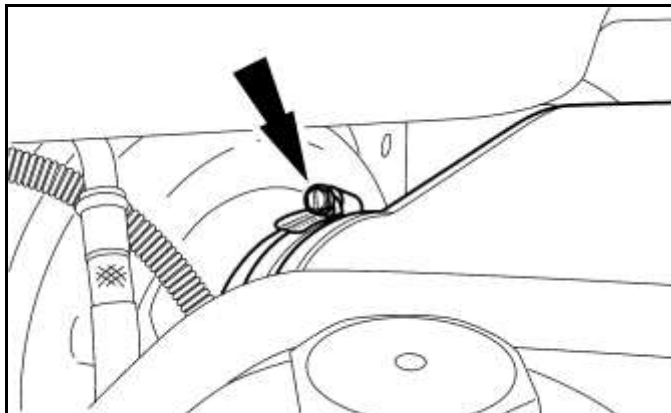

BD Engine Brake Inc.

Plant Address: 33541 MacLure Rd. Abbotsford, BC, Canada V2S 7W2

U.S. Shipping Address: 88-446 Harrison St, Sumas, WA 98295 U.S. Mailing Address: P.O. Box 231, Sumas, WA 98295

Phone: 604-853-6096 | Fax: 604-853-8749 | Internet: www.bd-power.com

Remove the marmon clamp from the turbocharger outlet and save for later use (11mm socket).

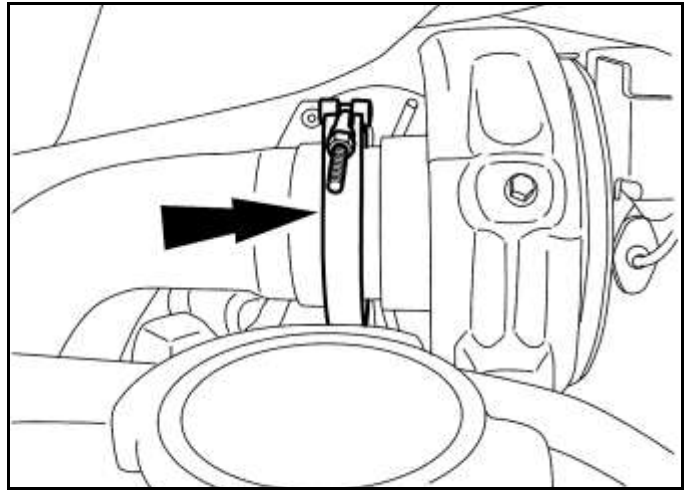

Disconnect the charge air cooler (CAC) 11mm inlet pipe.

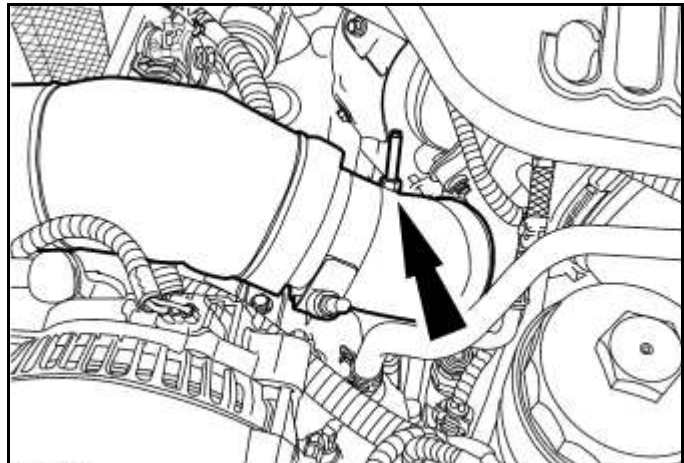

IF YOU HAVE REMOVED THE CAB, YOU CAN CONTINUE THE UN-INSTALLATION AT THIS POINT

Disconnect the turbocharger variable vane control valve electrical connector.

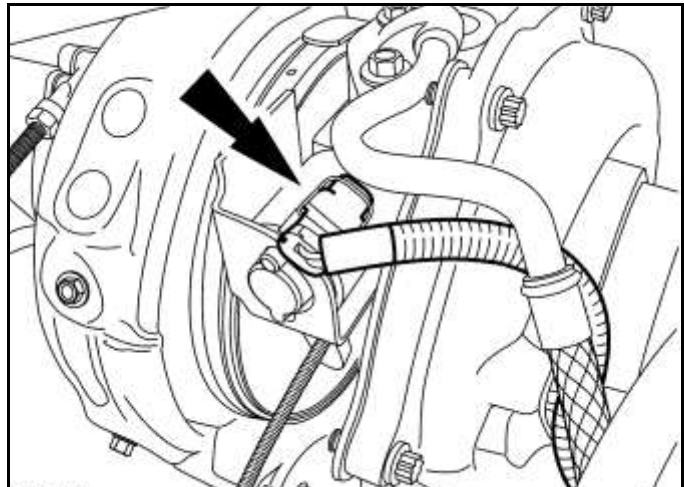

Remove the bolts for the oil supply tube (10mm).

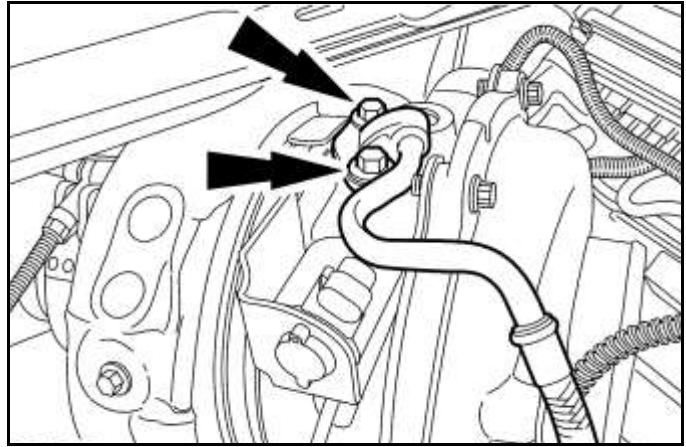

Remove the bolt and turbocharger oil supply (8mm). Save the bolt for later use.

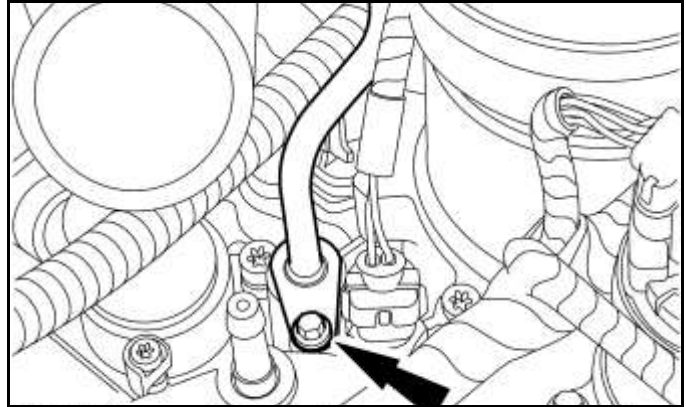

Remove the bolt and the wire retainer (10mm).

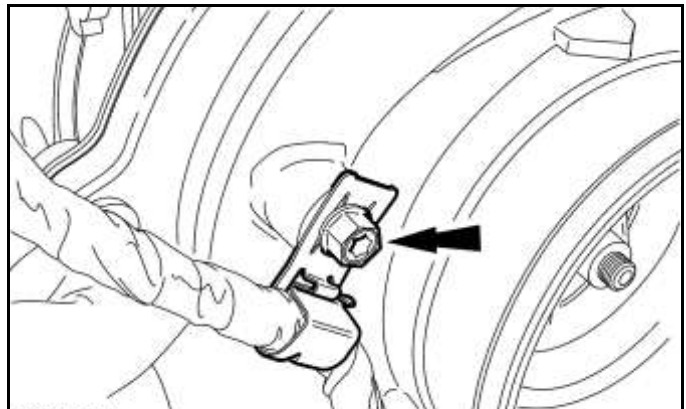

Remove the marmon clamp from the turbocharger exhaust inlet (11mm). Save for later use.

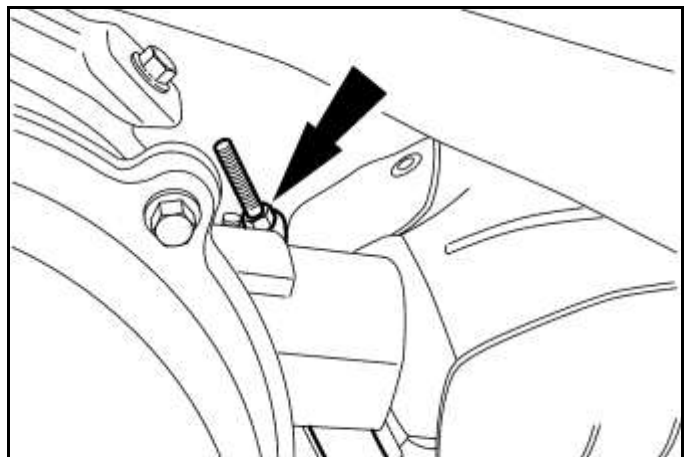

Remove the three bolts which secure the turbo to the pedestal (10 mm).

Remove the turbocharger.

Remove oil drain tube.

Remove the 4 bolts (10 mm socket) and the turbocharger pedestal. Save the four bolts for later use.

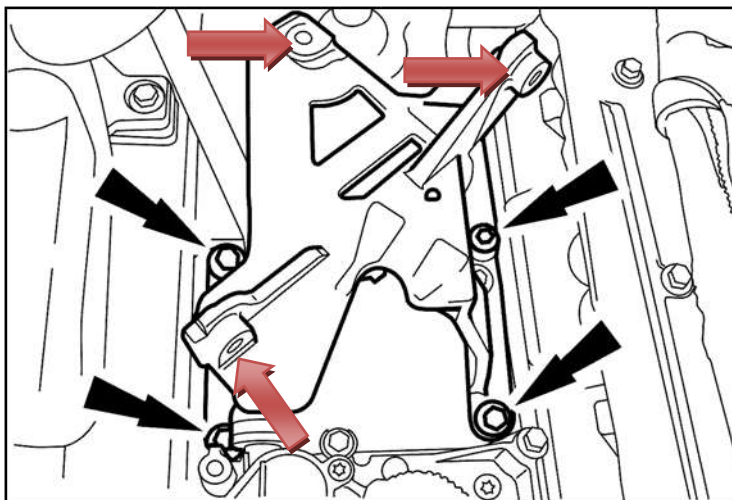

INSTALLATION OF BD TURBO AND COMPONENTS

CAB ON INSTALLATION

The turbo kit has been preassembled as an aid for the installer to see how the kit goes together.

After you have removed the BD Ford 6.0L turbo from the box, set it on a bench and disconnect the boost line at the tee connection. Do not damage the silicone line.



Then remove the turbocharger from the diverter valve and pedestal assembly by removing the four M10 flange nuts (15 & 17mm wrench/socket).

You will also need to remove the 10mm (6mm Allen) button socket cap screw that secures the wastegate bracket to the pedestal.



NOTE: After removing the turbo from the assembly temporarily reconnect the flange nuts and M10 bolts to hold the diverter valve bracket in place.

A rounded tip allen key is recommended for the last step.

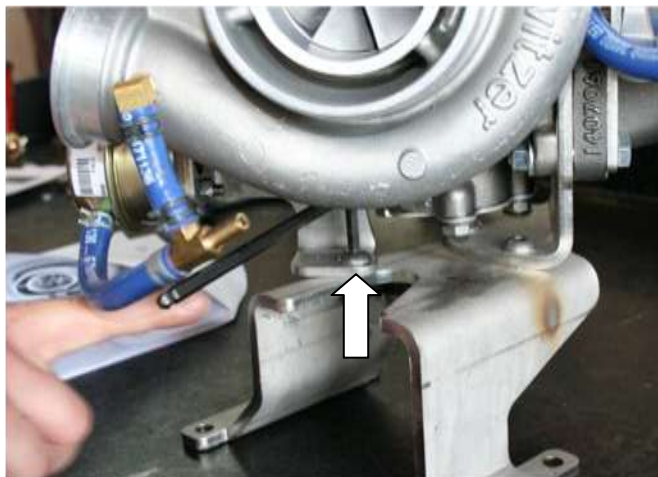

BD Engine Brake Inc.

Plant Address: 33541 MacLure Rd. Abbotsford, BC, Canada V2S 7W2

U.S. Shipping Address: 88-446 Harrison St, Sumas, WA 98295 U.S. Mailing Address: P.O. Box 231, Sumas, WA 98295

Phone: 604-853-6096 | Fax: 604-853-8749 | Internet: www.bd-power.com

With the turbo removed from the assembly you can now easily install the (#1459110) Heat Wrap onto turbine housing.

Do this by first placing the narrow piece on top of the wide piece with the reflective side facing out. Secure the two pieces together with staples.

Then weave the stainless wire through the inner and outer layers, length ways or along the two longer sides.

Wrap the assembly around the turbine housing, tighten the stainless wires around the turbo and twist them together to tighten the wrap.

Then wrap the outer layer (shiny side out) around the inner layer using the wire provided and weave the wire through the outer layer and synch into position, so the wrap cannot work itself loose.

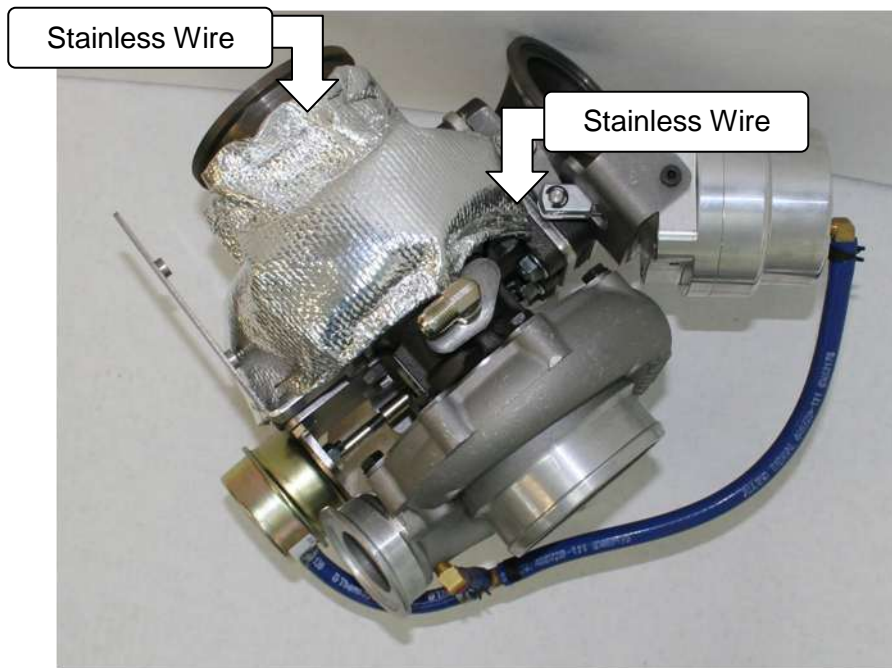

Disconnect the diverter valve assembly from the pedestal; assembly by removing the three button head sockets bolts using a 6 mm allen key.



BD Engine Brake Inc.

Plant Address: 33541 MacLure Rd. Abbotsford, BC, Canada V2S 7W2

U.S. Shipping Address: 88-446 Harrison St, Sumas, WA 98295 U.S. Mailing Address: P.O. Box 231, Sumas, WA 98295

Phone: 604-853-6096 | Fax: 604-853-8749 | Internet: www.bd-power.com

You should now be left with the pedestal base to start the installation of the turbo into the truck.



The solenoid holder will need to be installed using the front driver's side pedestal mounting bolt that you removed earlier.

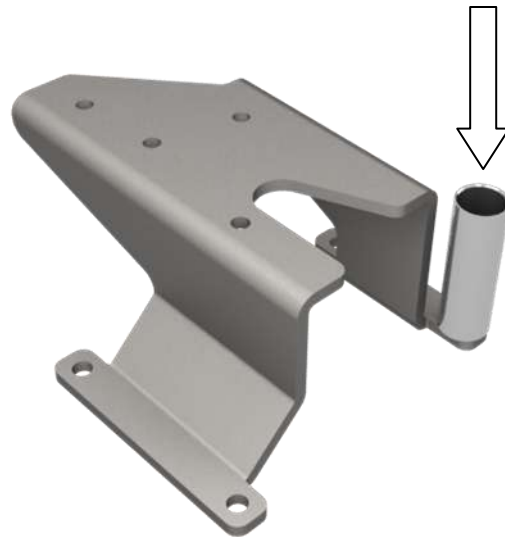

Install the pedestal base and solenoid holder (#1407087) re-using the four bolts from the OE base. A 10mm socket and extension should be used.

Torque to 23 lbft.



Place the OE V-band clamps for the turbo exhaust inlets and outlets onto their respective pipes. These clamps should be left over from the removal of the factory turbo. The largest V-Band clamp is the exhaust outlet, while the smallest is the turbine inlet.

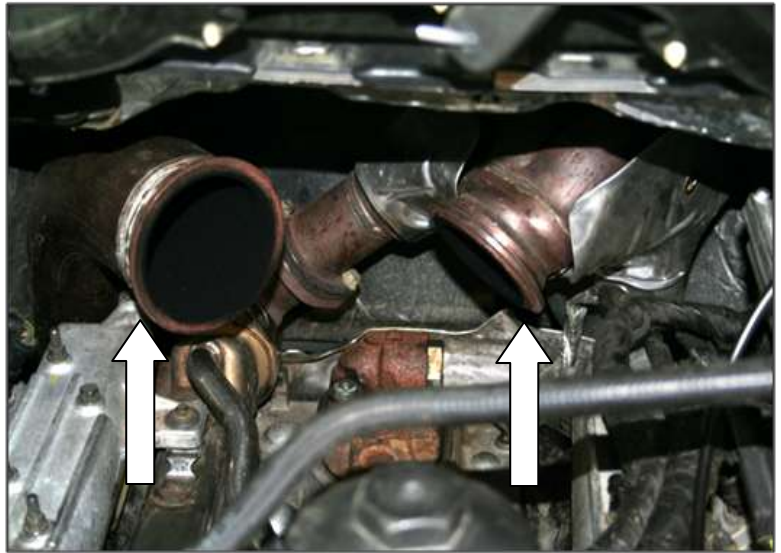

Use three of the M10 button head (6mm head) screws to secure the diverter valve assembly to the pedestal base. Ensuring all screws are securely in place.

Install the feed pipe v band clamp loosely to allow ease of the turbo install.

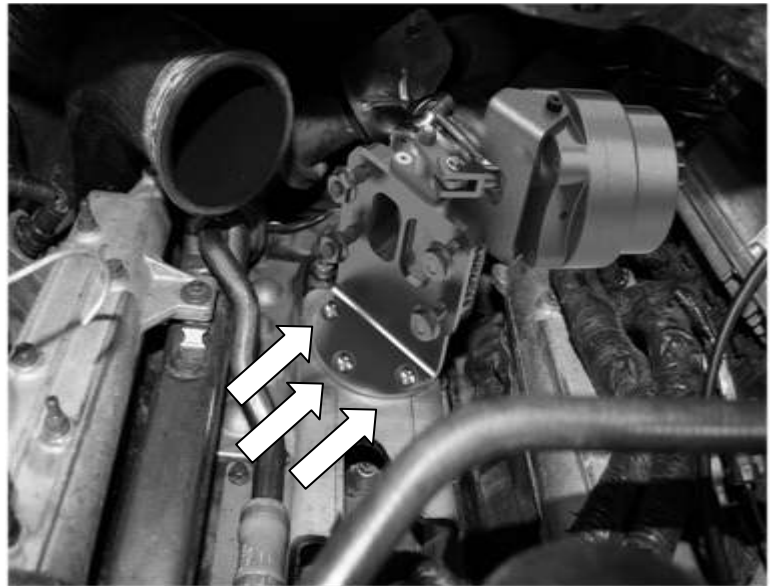

BD Engine Brake Inc.

Plant Address: 33541 MacLure Rd. Abbotsford, BC, Canada V2S 7W2

U.S. Shipping Address: 88-446 Harrison St, Sumas, WA 98295 U.S. Mailing Address: P.O. Box 231, Sumas, WA 98295

Phone: 604-853-6096 | Fax: 604-853-8749 | Internet: www.bd-power.com

Install supplied Oring (#1400283) onto the oil drain (#1407077). Lubricate with engine oil before installing.

Install the oil drain (#1407077) into the factory oil drain location. Ensure that it is fully seated inside of the hole and that it is concentric with the bore.

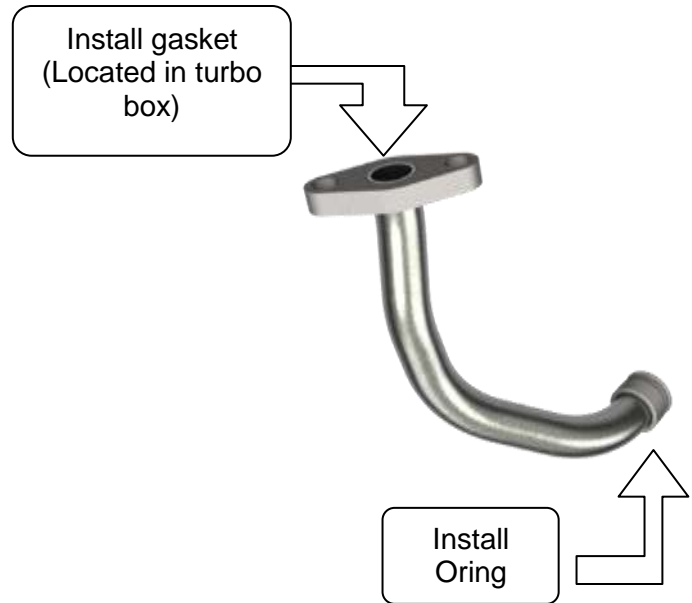

****Important**** Use the oil drain gasket from the turbo box and place between the turbo and the oil drain flange.

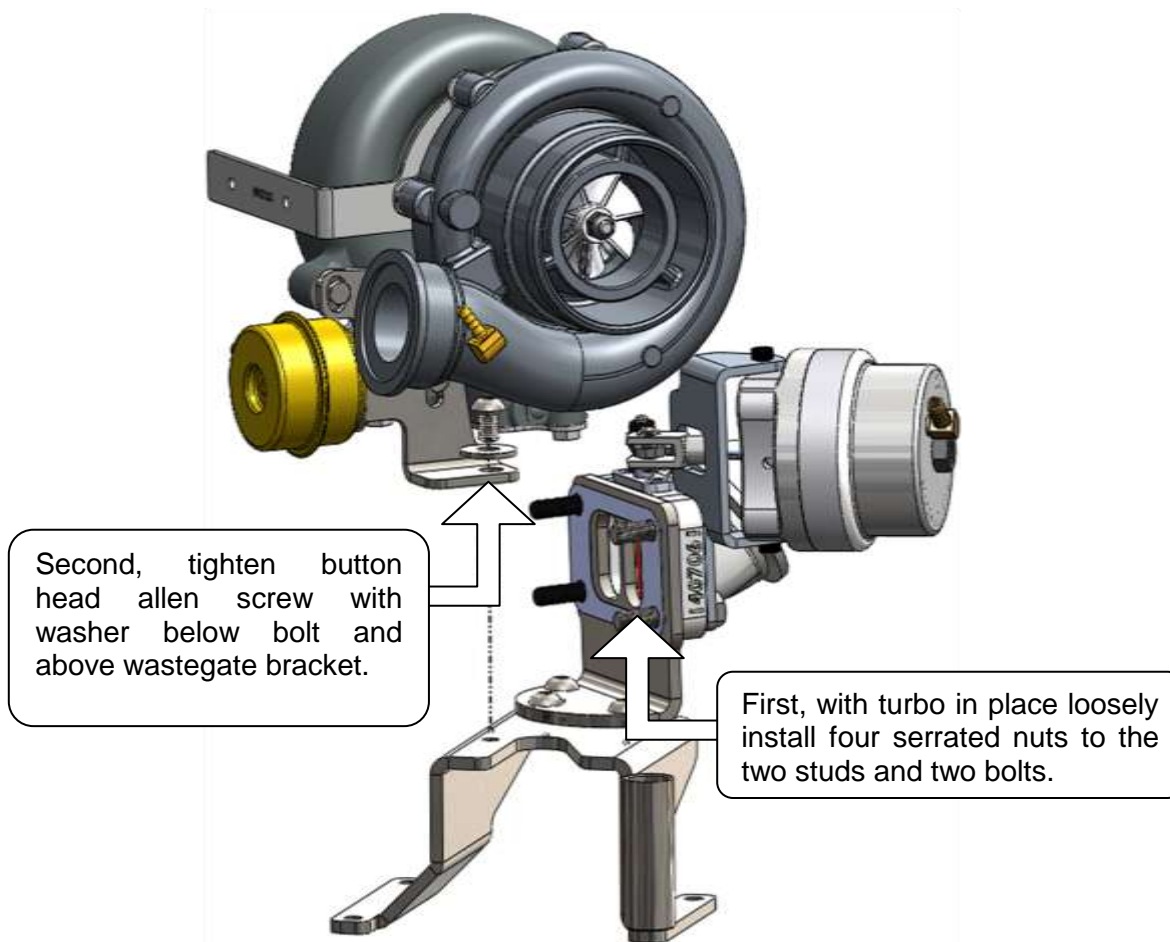

Install turbo to pedestal and diverter assembly.

Loosely install the 4 nuts onto the 2 studs and 2 bolts thereby securing the turbo to the diverter valve assembly. With everything loose, install the 4th M10 button socket bolt through the wastegate support plate, using the M10 washer between the bolt and the wastegate plate (Torque to 23 lbft).

Keep this bolt loose while tightening the 4 nuts (15mm wrench, 32 lbft) that secure the turbo turbine housing to the 'L' bracket. Tighten the last M10 button head bolt to secure the wastegate bracket in place.

Install and tighten both the downpipe v band clamp and tighten exhaust turbine feed clamp.

Reinstall the silicone air tubing and clamps for wastegate and diverter valve control.

BD Engine Brake Inc.

Plant Address: 33541 MacLure Rd. Abbotsford, BC, Canada V2S 7W2

U.S. Shipping Address: 88-446 Harrison St, Sumas, WA 98295 U.S. Mailing Address: P.O. Box 231, Sumas, WA 98295

Phone: 604-853-6096 | Fax: 604-853-8749 | Internet: www.bd-power.com

Install the Heat Shield (#1407088) over the existing heat wrap using the M6 bolts (#1130182) and washers (#1130184).

Torque to 89 lbin.



Insert oil drain flat gasket between turbo outlet and top of oil drain.

Use the two M8 bolts (#1030099) 13mm socket and lock washers (#1604102) to secure the drain to the turbo. Torque to 23lbft

For 2003-04 model year trucks, you will need to install the (#1407062) oil fitting, into the factory oil supply hole.



#1407062
(2003-04 Trucks)

For 2005-07 year trucks, you will need to use the (#1407072Z) oil adapter. Install supplied Oring (#1407078) into fitting land area. Then install assembly into hole.



#1407072Z
#1407071
#1407078
(2005-07 Trucks)

Be sure to lubricate the oring before installation.

Secure the fitting in place with the S/S oil line clamp (#1407071) and the OE bolt (8mm socket, torque to 89inlb).

Pre-oil the turbo with clean motor oil. Connect the oil inlet line (#1407063) to the fitting on the inlet of the turbo. Connect the other end of the oil line to the oil supply fitting you installed earlier. The 45° fitting should be installed at the turbo end. (3/4" wrench) Tighten the fitting to 20 lbft.

Ensure that the line does not contact or rub on anything.

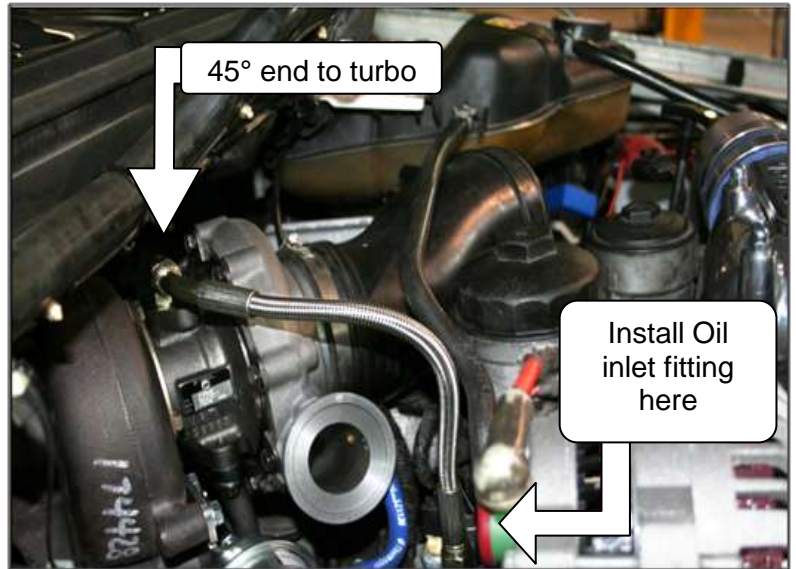

Install the compressor outlet adapter (#1407074) along with the O-Ring (#1453251) and V-band clamp (#1452225). (11mm socket). Tighten 53 lbin.

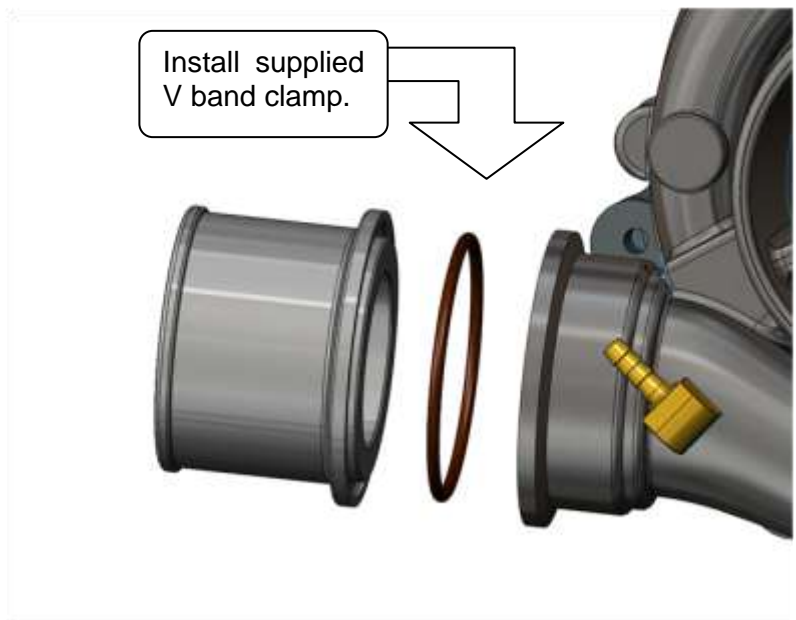

BD Engine Brake Inc.

Plant Address: 33541 MacLure Rd. Abbotsford, BC, Canada V2S 7W2

U.S. Shipping Address: 88-446 Harrison St, Sumas, WA 98295 U.S. Mailing Address: P.O. Box 231, Sumas, WA 98295

Phone: 604-853-6096 | Fax: 604-853-8749 | Internet: www.bd-power.com

Trim the silicone boot to the lower line. Install the boot using the factory clamps to connect the compressor outlet adapter to the CAC pipe.

Be sure to clean the silicone boot and CAC pipe with brake clean.

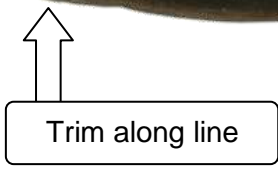

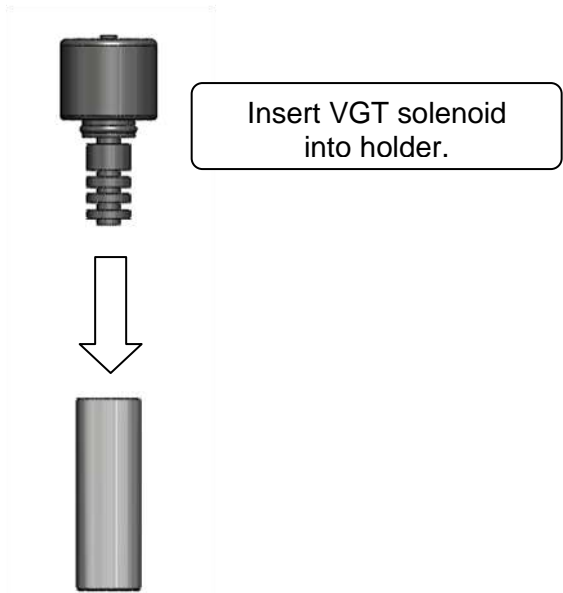

Remove the VGT Solenoid from the stock turbo.

Install VGT solenoid by inserting the solenoid into the holder located on the pedestal base and connect the factory electrical harness.



Remove the bracket from the intake tube and reinstall it on the engine to support the FICM with two OEM nuts.

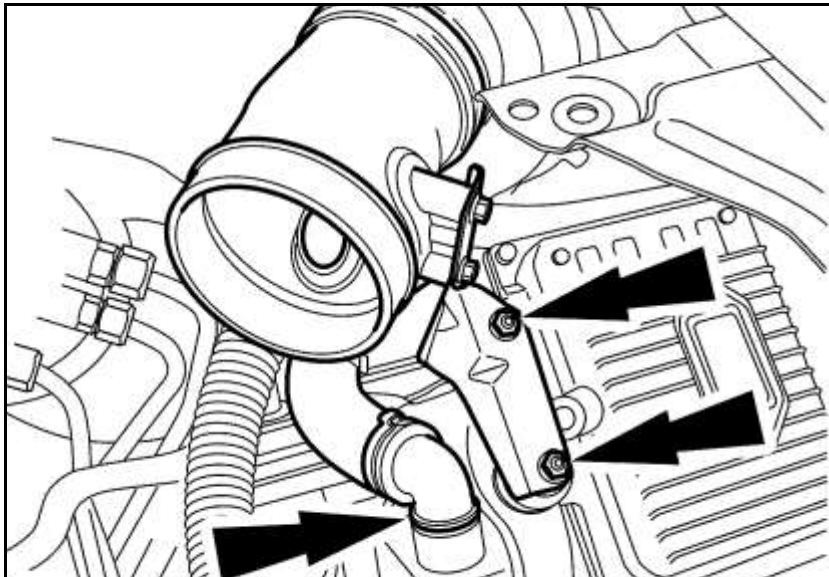

You will not be remounting the CCV tube to the bracket. We have provided you with a new hose clamp (#1453113) to secure the CCV connection.

The BD turbo sits higher than the stock turbo, so to accommodate this, the intake tube needs to be installed at a downward angle and rotated slightly. Tighten all the intake clamps and re-install the air filter tubing. (8mm Head). Torque to 44 lbin



BD Engine Brake Inc.

Plant Address: 33541 MacLure Rd. Abbotsford, BC, Canada V2S 7W2

U.S. Shipping Address: 88-446 Harrison St, Sumas, WA 98295 U.S. Mailing Address: P.O. Box 231, Sumas, WA 98295

Phone: 604-853-6096 | Fax: 604-853-8749 | Internet: www.bd-power.com

Reconnect all previous connections. Tighten all CAC clamps to 9 lbft..

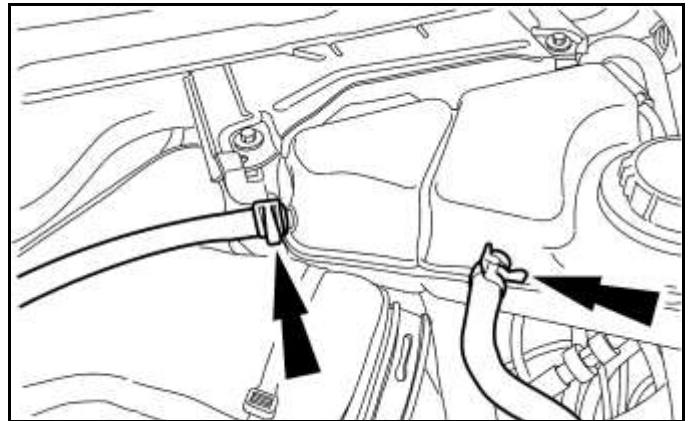
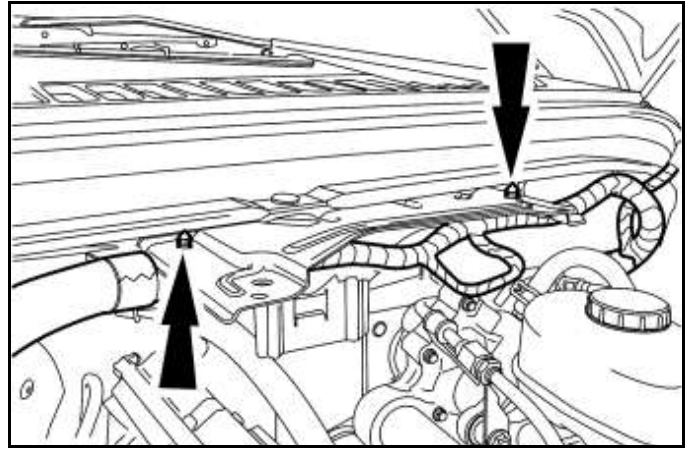

Allow the vehicle to idle for about 5-10 minutes and ensure that there are no oil leaks. Once the truck has finished idling, take the vehicle for a test run and ensure that there are no boost or exhaust leaks.

As well it is very common for the EGR Valve to leak boost pressure. Check this area.

*** IMPORTANT ***

UNDER NO CIRCUMSTANCES ADJUST THE DIVERTOR VALVE

BD Engine Brake Inc.

Plant Address: 33541 MacLure Rd. Abbotsford, BC, Canada V2S 7W2

U.S. Shipping Address: 88-446 Harrison St, Sumas, WA 98295 U.S. Mailing Address: P.O. Box 231, Sumas, WA 98295

Phone: 604-853-6096 | Fax: 604-853-8749 | Internet: www.bd-power.com

INSTALLATION WITH THE CAB-OFF

Loosen (4) feed pipe bolts on both the passenger and driver's side exhaust manifolds.
(10mm & 13mm)



Remove EGR Cooler clamp.
(11mm socket)



BD Engine Brake Inc.

Plant Address: 33541 MacLure Rd. Abbotsford, BC, Canada V2S 7W2

U.S. Shipping Address: 88-446 Harrison St, Sumas, WA 98295 U.S. Mailing Address: P.O. Box 231, Sumas, WA 98295

Phone: 604-853-6096 | Fax: 604-853-8749 | Internet: www.bd-power.com

Push feed pipe assembly towards transmission

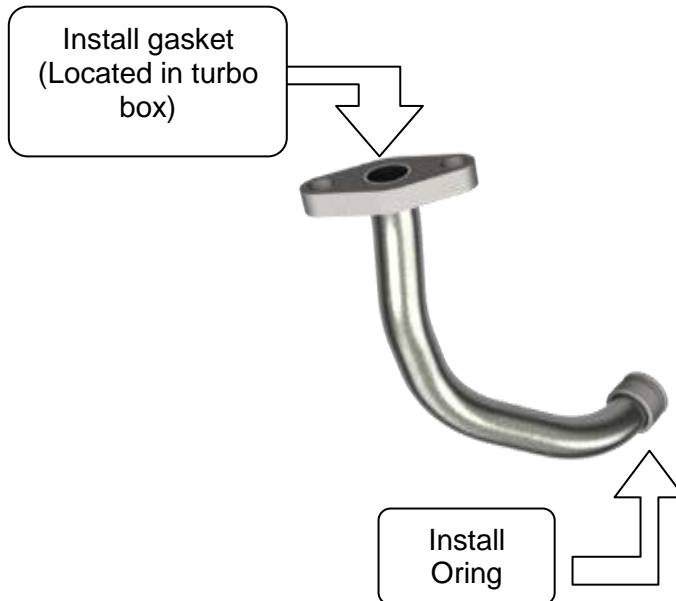

First install the supplied oring (#1400283) on to the oil drain assembly. Be sure to prelube the oring for this.

Insert the oil drain assembly (#1407077) and oring into the oil drain recessed hole.

Be sure the oil drain is square and concentric with the bore.



Install the (#1459110) Heat Wrap onto turbine housing.

Do this by first placing the narrow piece on top of the wide piece with the reflective side facing out. Secure the two pieces together with staples.

Then weave the stainless wire through the inner and outer layers, length ways or along the two longer sides.

Wrap the assembly around the turbine housing, tighten the stainless wires around the turbo and twist them together to tighten the wrap.

Then wrap the outer layer (shiny side out) around the inner layer using the wire provided and weave the wire through the outer layer and synch into position, so the wrap cannot work itself loose.

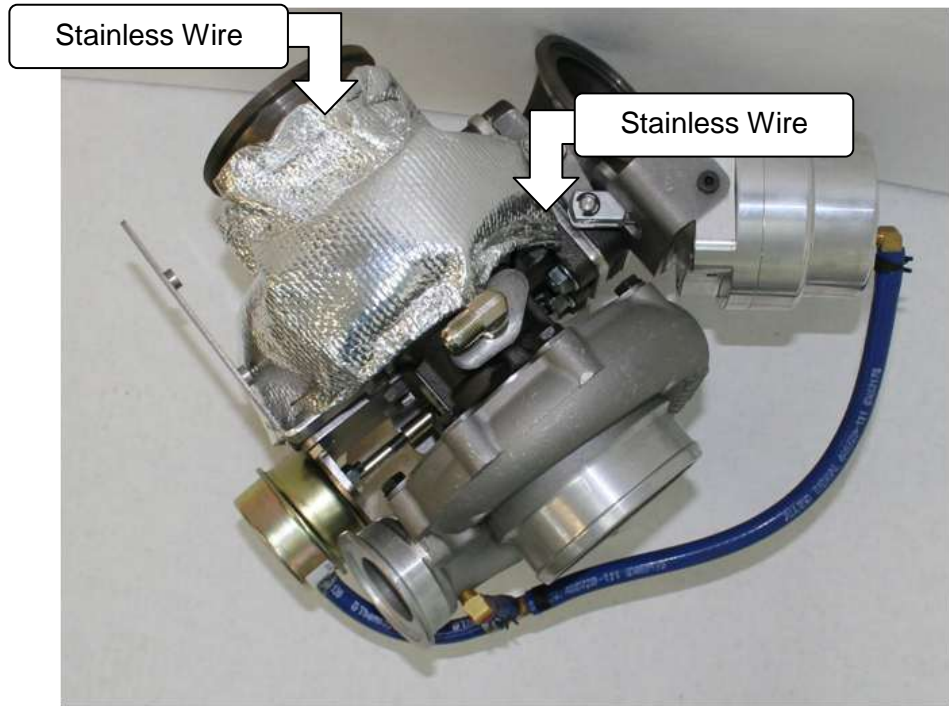

Slide the V-Bands Clamps over and downpipe and feed pipes. Install the turbo Assembly.

NOTE: Be careful to rotate oil drain past wastegate rod. Drain should remain movable while turbo is being mounted.





Install the pedestal base bolts and solenoid holder (4) bolts (10mm).

On the driver's side front, you will need to install the VGT solenoid holder. Use the factory bolt to secure the holder to the pedestal base. Torque to 23 lbft.

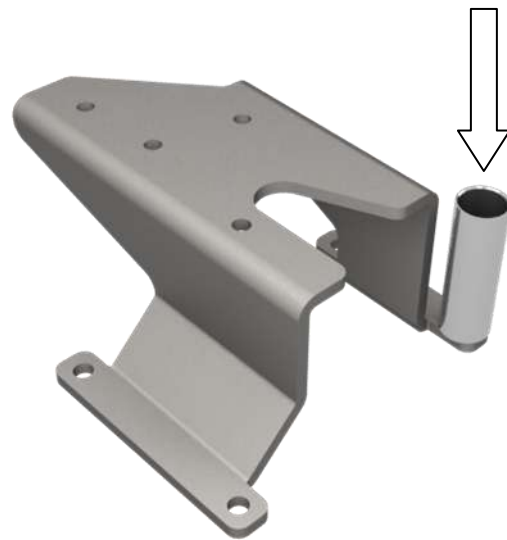

Push forward the feed pipe assembly to mate with the turbo and EGR Cooler.

Be sure to reinstall the EGR cooler gasket.



BD Engine Brake Inc.

Plant Address: 33541 MacLure Rd. Abbotsford, BC, Canada V2S 7W2

U.S. Shipping Address: 88-446 Harrison St, Sumas, WA 98295 U.S. Mailing Address: P.O. Box 231, Sumas, WA 98295

Phone: 604-853-6096 | Fax: 604-853-8749 | Internet: www.bd-power.com

Install the V band clamp for the downpipe (torque to 9 lbft), feed pipe (torque to 9 ftlb) and EGR Cooler (torque to 53 lbin). Tighten feed pipe bolts at manifolds (torque to 20 lbft).

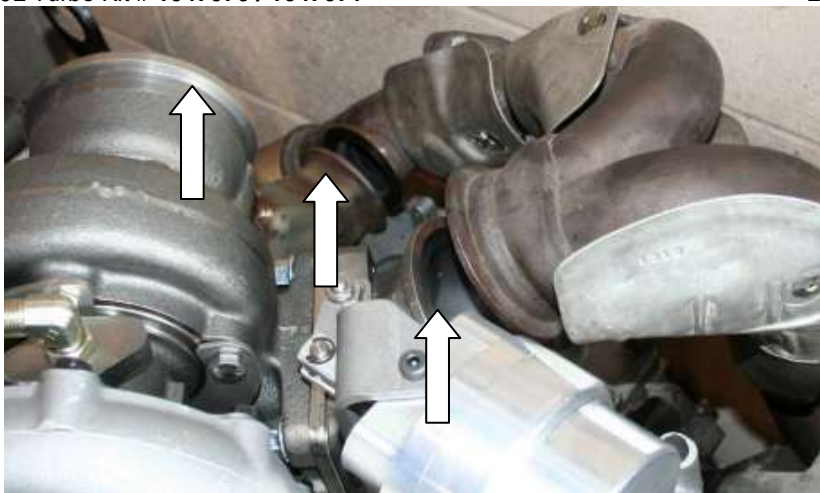

Insert oil drain gasket between turbo oil drain outlet and oil drain assembly.

Use the two M8 bolts (#1030099) 13mm socket and lock washers (#1604102) to secure the drain to the turbo. Be sure that the gasket is still in place before tightening drain tube.



Place the solenoid into the solenoid holder and connect the factory harness to the solenoid.



Insert VGT solenoid into holder.

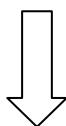

Install the Heat Shield (#1407088) over the existing heat wrap using the M6 bolts (#1130182) and washers (#1130184) Torque to 89lbin..



For 2003-04 model year trucks, you will need to install the (#1407062) oil fitting, into the factory oil supply hole.



#1407062
(2003-04 Trucks)

For 2005-07 year trucks, you will need to use the (#1407072Z) oil adapter.

Install supplied Oring (#1407078) into fitting land area. Then install assembly into hole.



#1407072Z
#1407071
#1407078
(2005-07 Trucks)

Be sure to lubricate the oring before installation.

Secure the fitting in place with the S/S oil line clamp (#1407071) and the OE bolt (8mm socket). Torque to 89 lbin.

BD Engine Brake Inc.

Plant Address: 33541 MacLure Rd. Abbotsford, BC, Canada V2S 7W2

U.S. Shipping Address: 88-446 Harrison St, Sumas, WA 98295 U.S. Mailing Address: P.O. Box 231, Sumas, WA 98295

Phone: 604-853-6096 | Fax: 604-853-8749 | Internet: www.bd-power.com

Pre-oil the turbo with clean motor oil. Connect the oil inlet line (#1407063) to the fitting on the inlet of the turbo. Connect the other end of the oil line to the oil supply fitting you installed earlier. The 45° fitting should be installed at the turbo end. (3/4" wrench)

Ensure that the line does not contact or rub on anything. Torque to 20 lbft.

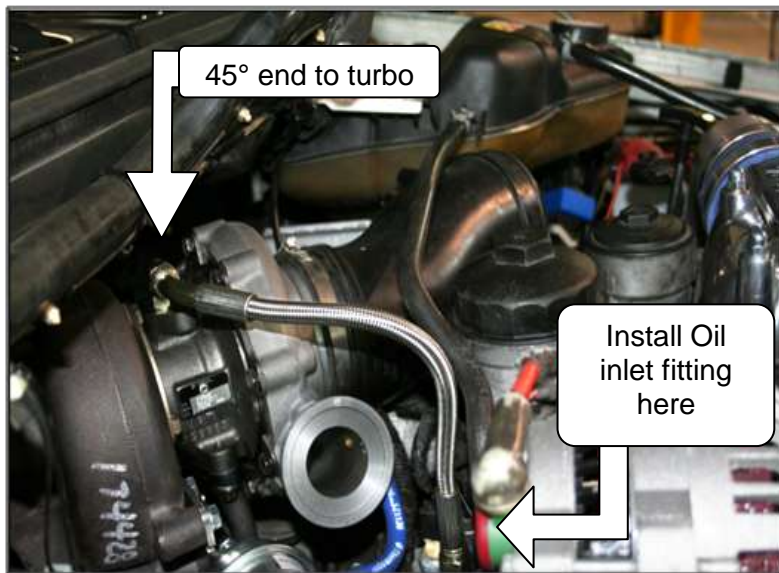

Install the compressor outlet adapter (#1407074) along with the O-Ring (#1453251) and V-band clamp (#1452225). (11mm socket). Torque to 53lbft.

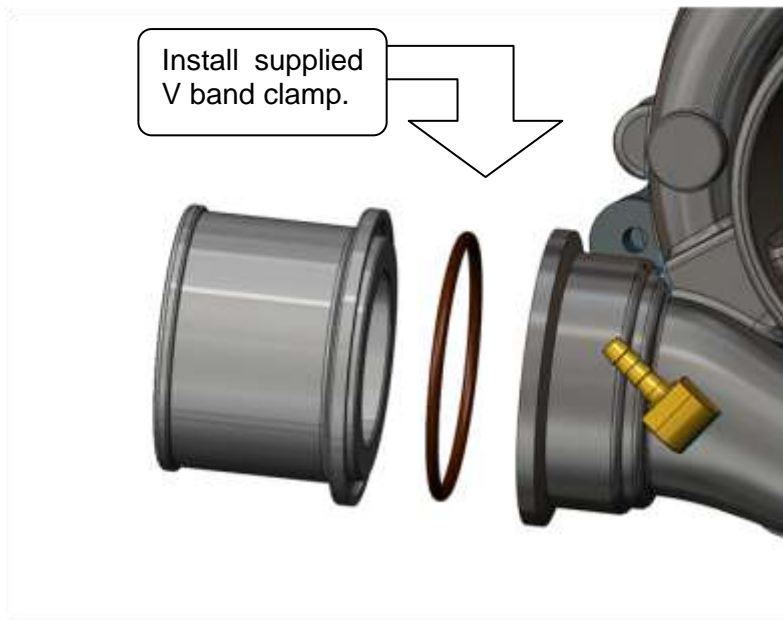

Remove the bracket from the intake tube and reinstall it on the engine to support the IDM with two nuts.

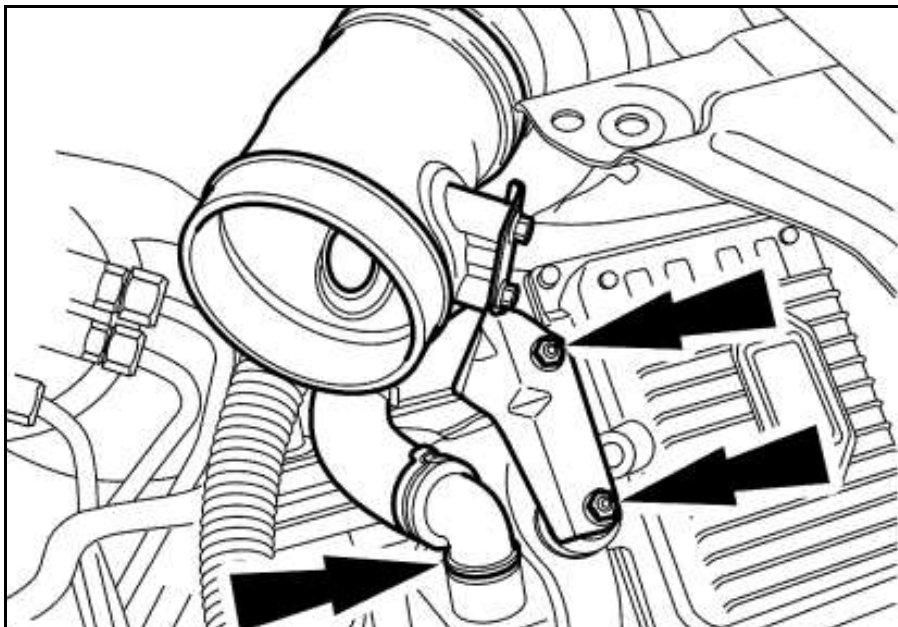

You will not be remounting the CCV tube to the bracket. We have provided you with a new hose clamp (#1453113) to secure the CCV connection.

The BD turbo sits higher than the stock turbo, so to accommodate this, the intake tube needs to be installed at a downward angle and rotated slightly. Tighten all the intake clamps and re-install the air filter tubing.(8mm Head). Torque to 44 lbin.



BD Engine Brake Inc.

Plant Address: 33541 MacLure Rd. Abbotsford, BC, Canada V2S 7W2

U.S. Shipping Address: 88-446 Harrison St, Sumas, WA 98295 U.S. Mailing Address: P.O. Box 231, Sumas, WA 98295

Phone: 604-853-6096 | Fax: 604-853-8749 | Internet: www.bd-power.com

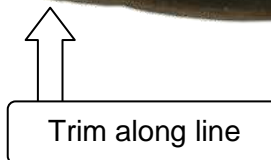

Trim the silicone boot to the lower line. Install the boot using the factory clamps to connect the compressor outlet adapter to the CAC pipe.

Be sure to clean the silicone boot and CAC pipe with brake clean.

Tighten all CAC clamps to 9 lbft.



Once the cab is back on allow the vehicle to idle for about 5-10 minutes and ensure that there are no oil leaks. Once the truck has finished idling, take the vehicle for a test run and ensure that there are no boost or exhaust leaks.

*** IMPORTANT ***

UNDER NO CIRCUMSTANCES ADJUST THE DIVERTER VALVE

IMPORTANT When idled for any length of time some oil may leak from the turbo. If the performance/boost is satisfactory and the wheel is not touching the housing (There will be some small movement), the excess oil is not a concern. Simply wipe with a clean cotton cloth and continue use.

BD Engine Brake Inc.

Plant Address: 33541 MacLure Rd. Abbotsford, BC, Canada V2S 7W2

U.S. Shipping Address: 88-446 Harrison St, Sumas, WA 98295 U.S. Mailing Address: P.O. Box 231, Sumas, WA 98295

Phone: 604-853-6096 | Fax: 604-853-8749 | Internet: www.bd-power.com

PCM PROGRAMS

With the installation of the Ford 6.0L turbo completed, install the recommended SCT Multi Loader software onto your PC. Open the supplied box, you should find an instruction manual. Below is a guide on what steps to follow.



Sections located in the SCT Multi Loader Manual

Step 1 :	Before programming vehicle, a. Ensure batteries are fully charged and all electrical accessories are turned off b. All performance chips/boxes/tuners are removed or uninstalled from the vehicle
Step 2 :	Plug in the SCT Flash unit into OBD/DLC connector
Step 3 :	Once unit powers up, scroll to "Program Vehicle", press "Select" to accept.
Step 4 :	Select "Strategy Tune", press "Select" to accept.
Step 5 :	Press "Select" to accept the disclaimer.
Step 6 :	Continue to follow instructions on screen.
Step 7 :	When "ADJUST OPTIONS" screen is displayed, scroll to "Adjust options" and press "Select".

BD Engine Brake Inc.

Plant Address: 33541 MacLure Rd. Abbotsford, BC, Canada V2S 7W2

U.S. Shipping Address: 88-446 Harrison St, Sumas, WA 98295 U.S. Mailing Address: P.O. Box 231, Sumas, WA 98295

Phone: 604-853-6096 | Fax: 604-853-8749 | Internet: www.bd-power.com

Step 8 :	<p>Scroll down through the options, and select “BD Turbo”.</p> <p>a. Once inside the “BD Turbo” adjustment screen, highlight “BD 6L Turbo” and press “Select” to accept. . A “checkmark” will appear when selected.</p>										
Step 9 :	<p>Now in the “ADJUST OPTIONS” main screen, scroll down to “EGR” and press “Select”.</p> <p>a. Once in the “EGR” options menu, highlight “EGR OFF” and press “Select” to accept. A “checkmark” will appear when selected.</p>										
Step 10 :	<p>Now in the “ADJUST OPTIONS” main screen, scroll down to “Tune Type” and press “Select”.</p> <p>a. Once in the “Tune Type” options menu, highlight your selected power level and press “Select” to accept. A “checkmark” will appear when selected.</p> <table border="1" data-bbox="672 814 1214 1041"> <tr> <td>Street</td> <td>85-90 HP</td> </tr> <tr> <td>Performance</td> <td>120-150 HP</td> </tr> <tr> <td>Tow 65 HP</td> <td>65 HP</td> </tr> <tr> <td>Tow 50 HP</td> <td>50 HP</td> </tr> <tr> <td>Trans Only</td> <td>0 HP</td> </tr> </table>	Street	85-90 HP	Performance	120-150 HP	Tow 65 HP	65 HP	Tow 50 HP	50 HP	Trans Only	0 HP
Street	85-90 HP										
Performance	120-150 HP										
Tow 65 HP	65 HP										
Tow 50 HP	50 HP										
Trans Only	0 HP										
Step 11 :	Press “Cancel” to continue to programming.										
Step 12 :	Follow the on screen instruction to complete programming.										

Important

- Do not remove/unplug are turn on/off any accessories when the tuner is programming.
- All custom tuning options will be saved in the SCT FLASH unit
- The other custom tuning options not listed are not recommend by BD Diesel. Please use at your own risk.

All the above steps and options are not CARB or EPA approved. ***For race use only.***

BD Engine Brake Inc.

Plant Address: 33541 MacLure Rd. Abbotsford, BC, Canada V2S 7W2

U.S. Shipping Address: 88-446 Harrison St, Sumas, WA 98295 U.S. Mailing Address: P.O. Box 231, Sumas, WA 98295

Phone: 604-853-6096 | Fax: 604-853-8749 | Internet: www.bd-power.com