

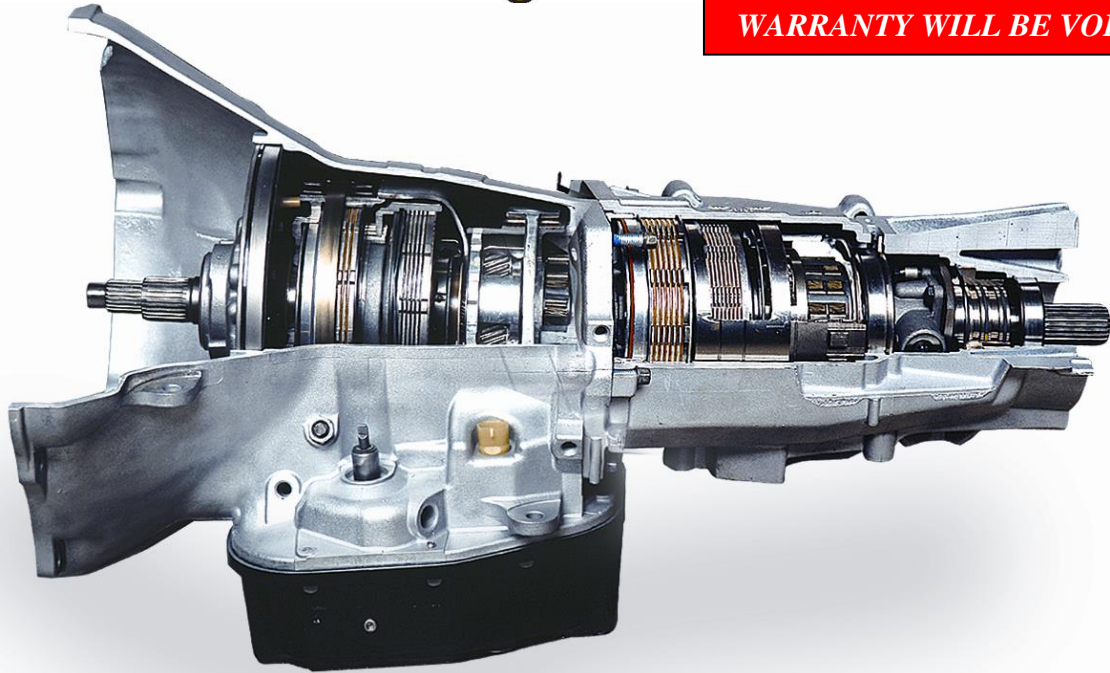

**DO NOT USE WATER-BASED TRANSMISSION FLUSHING FLUID – THE LINING IN THE CONVERTOR CLUTCHES WILL DISINTIGRATE, RENDERING THE CONVERTOR USELESS AND WARRANTY WILL BE VOIDED.**



# ***BD PERFORMANCE TRANSMISSION*** **Dodge Installation Instructions**

2WD Transmissions		
<b>1030310</b>	1991-93	518
<b>1064152</b>	1994-95 (12V)	47RH
<b>1064162</b>	1996-98 (12V)	47RE
<b>1064172</b>	1998-99 (24V)	47RE
<b>1064182</b>	2000-02 (24V)	47RE
<b>1064192</b>	2003-04 (24V)	48RE
<b>1064212</b>	2005 (24V)	48RE
<b>1064232</b>	2006-07 (24V)	48RE

4WD Transmissions		
<b>1030311</b>	1991-93	518
<b>1064154</b>	1994-95 (12V)	47RH
<b>1064164</b>	1996-98 (12V)	47RE
<b>1064174</b>	1998-99 (24V)	47RE
<b>1064184</b>	2000-02 (24V)	47RE
<b>1064194</b>	2003-04 (24V)	48RE
<b>1064214</b>	2005 (24V)	48RE
<b>1064234</b>	2006-07 (24V)	48RE

**\* Transmission kits are also available, which include a BD PressureLoc. Please read the instructions and disclaimer before beginning installation.**

***PRE INSTALLATION***

---

Before installing the transmission, the transmission cooler must be flushed and the filter be changed. Also ensure the vehicle has a BD Filter Kit ( PN# 1064017) for the BD Transmission you are about to install. If the vehicle is equipped the replacement filter can be ordered through BD using PN#1604008.

After flushing, check transmission cooler flow at engine idle. This can be accomplished by running the transmission cooler outlet into a bucket. There should be a minimum 1 GPM of flow.

Also if the transmission being replaced failed or there was excessive debris in the pan, the transmission cooler and check valve assembly will need to be replaced.

Failure to follow these procedures may void your warranty.

***Upon installation ensure the plug is in the torque converter and preload the torque converter with 2 quarts, fluid type see below.***

<b>Application</b>	<b>Oil Type</b>
All Dodge's (518, 47xx, 48re, 68 rfe	Mopar ATF +4

***Oil Filter Cross Reference***

HASTINGS	BALDWIN	DONALDSON	FLEETGUARD	FRAM	LUBER-FINER	WIX
LF364	BT230	P555570	LF3342	PH3519	LFP5570	51268

**WARNING**

**WHEN YOUR TRANSMISSION IS SERVICED AT A DEALER OR SERVICE CENTRE IT IS IMPERATIVE THAT THE BD FILTER BE REPLACED WITH THE SAME TYPE. THE PROPER FILTER IS CHRYSLER OEM PART # 3515996 WHICH WILL ENSURE THE MODIFIED VALVE BODY DOES NOT LEAK PAST THE FILTER SEAL.**

## **REMOVAL:**

---

1. Disconnect the negative battery cable(s).
2. Remove the torque converter access cover and inspection plate.
3. Remove the transmission pan, drain the fluid and re-install the pan.
4. Remove the fill tube bracket bolt and pull the tube out of the transmission. Retain the fill tube seal. On 4WD models, it will also be necessary to remove the bolt attached to the transfer case vent tube to the converter housing.
5. Rotate the crankshaft with a pry bar from under the vehicle until the converter bolts are accessible.
6. Mark the drive shaft and pinion yokes for assembly alignment. Disconnect and remove the drive shaft. On 4WD models, remove both drive shafts.
7. Disconnect the electrical wiring from the park/neutral position switch, transmission solenoid, and speed sensor.
8. Disconnect the gearshift rod and shifter shaft assembly from the transmission.
9. Disconnect the TV (throttle valve) cable from the transmission bracket.
10. On 4WD models, disconnect the shifter rod from the transfer case shift lever. For 04.5-08 48RE transmissions, the TTVA motor will need to be removed.
11. Raise the transmission slightly by using a service jack to relieve the load on the cross-member and supports.
12. Remove the bolts securing the rear support and cushion to the transmission and cross-member.
13. Disconnect the vacuum lines and remove the steel line from the cross-member and frame.
14. Remove the bolts attaching the cross-member to the frame. Spread the frame with a Port-A-Power to remove the cross-member.
15. On 4WD models, remove the transfer case with a transmission jack or with the aid of a helper.
16. Disconnect the fluid cooler lines at the transmission.
17. Remove all bell housing bolts.

BD Engine Brake Inc.

Plant Address: 33541 MacLure Rd. Abbotsford, BC, Canada V2S 7W2

U.S. Shipping Address: 88-446 Harrison St, Sumas, WA 98295 U.S. Mailing Address: P.O. Box 231, Sumas, WA 98295

Phone: 604-853-6096 | Fax: 604-853-8749 | Internet: [www.bd-power.com](http://www.bd-power.com)

18. Carefully work the transmission and torque converter assembly rearward off the engine block dowels.
19. Lower the transmission and remove assembly from under the vehicle.
20. Carefully slide the torque converter out of the transmission.

## **INSTALLATION:**

---

1. Flush the cooler and all cooler lines before installing the transmission. BD only recommends using a back flow capable transmission flush machine, using clean transmission fluid only. DO NOT USE "TRANSMISSION FLUSH IN A CAN" products.

**DO NOT USE WATER-BASED TRANSMISSION FLUSHING FLUID – THE LINING IN THE CONVERTOR CLUTCHES WILL DISINTEGRATE, RENDERING THE CONVERTOR USELESS AND WARRANTY WILL BE VOIDED.**

2. **\*\*\*NOTE:** If new bolts are supplied with the converter, be sure to remove the bolts before installing the transmission.
3. Lubricate the converter drive hub and oil pump seal lip with petroleum jelly.
4. Lubricate the converter pilot hub with transmission fluid.
5. Align and install the torque converter into the oil pump.
6. Carefully insert the converter into the oil pump. Rotate the converter back and forth until it's fully seated in the pump gears. Two loud "clunks" should be heard to ensure it is seated properly.
7. Position the transmission on a service jack and secure it with chains.
8. Check the condition of the converter drive plate. If the plate is cracked, distorted or damaged, it must be replaced before installation can continue. **Also be sure the transmission dowel pins are seated in the engine block and protrude far enough to hold the transmission in alignment.**
9. Raise the transmission and align the torque converter with the drive plate, and the bell housing with the engine block.
10. Move the transmission forward. Raise, lower or tilt the transmission to align the bell housing with the engine block dowels.
11. Carefully work the transmission forward and over the engine block dowels until the converter hub is seated in the crankshaft.
12. Install the bolts attaching the bell housing to the engine.
13. Tighten the bolts and check the torque converter rotation.
14. Install the rear support. Lower the transmission onto the cross-member and install the bolts attaching the transmission mount to the cross-member.

BD Engine Brake Inc.

Plant Address: 33541 MacLure Rd. Abbotsford, BC, Canada V2S 7W2

U.S. Shipping Address: 88-446 Harrison St, Sumas, WA 98295 U.S. Mailing Address: P.O. Box 231, Sumas, WA 98295

Phone: 604-853-6096 | Fax: 604-853-8749 | Internet: [www.bd-power.com](http://www.bd-power.com)

15. Reconnect the vacuum lines and re-install the steel line to the cross-member and frame.
16. Reconnect the shift linkages.
17. Connect the gearshift and throttle cable to the transmission.  
For 2004.5 –2008 48RE transmissions reinstall the TTVA motor.
18. Connect the electrical wires to the park/neutral position switch and transmission solenoid(s). Be sure the transmission harnesses are properly routed.

**CAUTION: It is essential that correct length bolts be used to attach the converter to the drive plate. Bolts that are too long will damage the clutch surface inside the converter.**

19. Install the torque converter to drive plate bolts using Loctite. On models with a 12.2" converter, tighten bolts to 47 Nm (35 ft. lbs.).
20. Install the torque converter housing access covers.
21. Install the cooler line bracket.
22. Connect the cooler lines to the transmission.
23. Install the transmission fill tube. Install a new seal on the tube before installation.
24. Align and connect the drive shaft.
25. Adjust the gearshift linkage and throttle valve cable if necessary.
26. Lower the vehicle.
27. Reconnect the negative ground cable(s) to your battery(s).
28. Fill the transmission with vehicle manufacturers suggested fluid.  
**NOTE:** Fill capacities listed only as a guide. **Correct fluid level should always be determined by marks on dipstick.** Capacities listed are total system capacity including torque converter and BD pan.

<u>Application</u>	<u>First Fill Quarts (Liters)</u>	<u>Secondary Fill Quarts (Liters)</u> <u>(Includes TC Preload)</u>	<u>Total Capacity</u> <u>(Liters)</u>
1988-2007	10 (9.5)	Approx 7 (6.6)	Approx 17 (16.1)

<b>Mainline Pressures</b>				
	<b>At Idle</b>	<b>Wide Open throttle</b>	<b>In Reverse (Idle)</b>	<b>In Reverse (WOT)</b>
Dodge 47RH	90-100 psi	170-180 psi	250 psi	350 psi
Dodge 47RE	90-100 psi	170-180 psi	250psi	350 psi
Dodge 48RE	90-100 psi	170-180 psi	250 psi	350 psi

## **KICK-DOWN CABLE ADJUSTMENT**

Kick-down cable adjustment is one of the most critical adjustments that affect the operation of the transmission.

The BD Performance Valve Body is a performance product and not stock, therefore the factory specifications for this adjustment are used only as a guide.

***Your drivability and performance demands will determine your shift points and pressure adjustments.***

Kick down cable adjustments are for Full Throttle shift points & passing gear only. Light Throttle shift points should be adjusted on the valve body throttle valve stop.

### **12 VALVE ADJUSTMENTS**

On trucks equipped with the **12-valve 5.9 6BTA**, full throttle shift between 2<sup>nd</sup> and 3<sup>rd</sup> should occur between 2400 – 2500RPM (OEM) with the transmission at operating temperature.

**IMPORTANT** - Locate the kick-down cable and **MARK THE CABLE** at the original setting before any adjustments are made.

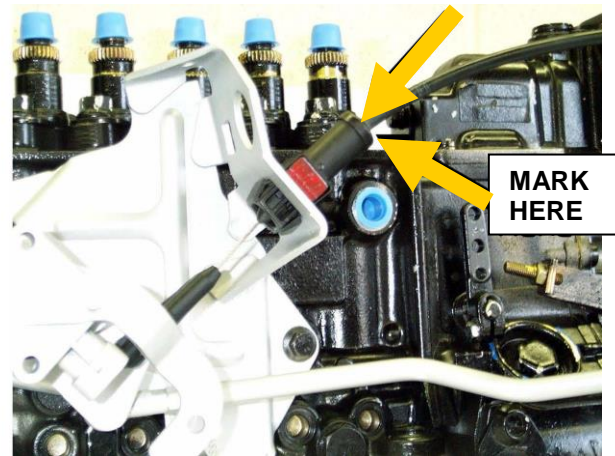
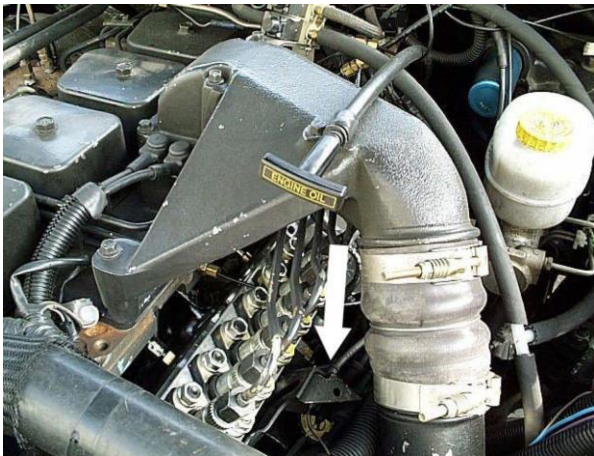

**NOTE:** Disconnecting the cable from the support bracket and the throttle lever is a difficult task; it may be easier to adjust without removing cable.

## **24 VALVE ADJUSTMENTS**

On trucks equipped with Cummins ISB engines, full throttle shift between 2<sup>nd</sup> and 3<sup>rd</sup> should occur between 2800 – 3000 rpm (OEM) with transmission at operating temp. The kick down cable will be located underneath the plastic cover as indicated below.

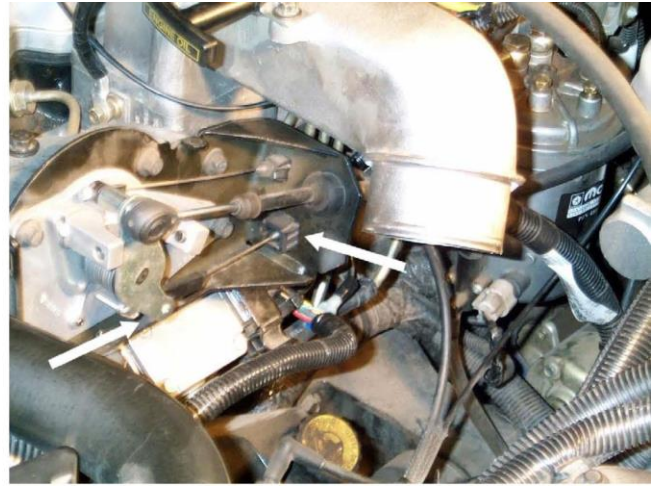

The plastic cover is held in place by 2 plastic Phillips head screws, only light pressure is required to remove them. Do not lose the screws or washers when you remove them. Remove the cable from the throttle linkage and support bracket.



**\*\*IMPORTANT: MARK THE CABLE** at the original setting before any adjustments are made.

Remove the white colored locking clip from the cable.

Press the lock tab (this will take considerable force) to release the locking mechanism.

### **BD Engine Brake Inc.**

Plant Address: #A10 – 33733 King Road, Abbotsford, BC, Canada V2S 7M9  
US Shipping: #88 – 446 Harrison St., Sumas, WA, USA 98295 | US Mailing Address: P.O. Box 231, Sumas, WA, USA, 98295  
Phone#: (604) 853-6096 | Fax: (604) 853-8749 | Web: [www.dieselperformance.com](http://www.dieselperformance.com)



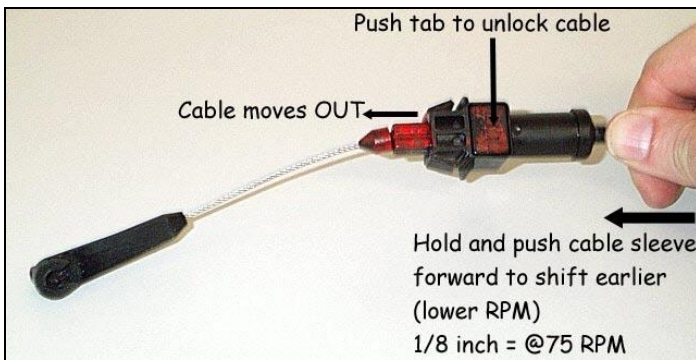

*Adjusting the cable forward, towards the radiator, will make the transmission shift sooner.*

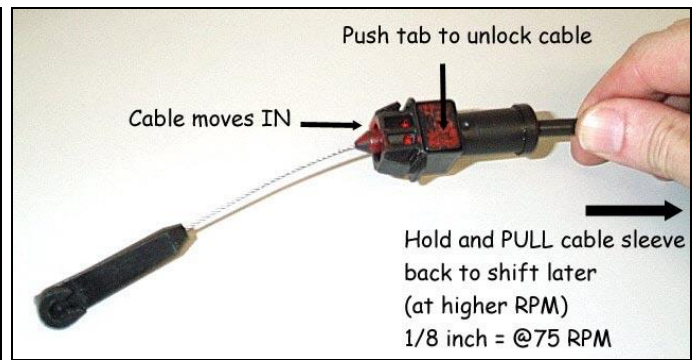

*Adjusting the cable rearward, towards the firewall, will make the transmission shift later.*

**\*\*CAUTION\*\* DO NOT USE A SCREWDRIVER TO REMOVE CLIP, IF THE CLIP BREAKS THE CABLE WILL HAVE TO BE REPLACED!**

**(Adjustment spec - 1/8 inch movement = ~75 rpm)**



Install white locking clip and then re-install the cable through the support bracket and then on to the throttle lever. Install plastic cover when job is complete.

**BD Engine Brake Inc.**

Plant Address: #A10 – 33733 King Road, Abbotsford, BC, Canada V2S 7M9

US Shipping: #88 – 446 Harrison St., Sumas, WA, USA 98295 | US Mailing Address: P.O. Box 231, Sumas, WA, USA, 98295

Phone#: (604) 853-6096 | Fax: (604) 853-8749 | Web: [www.dieselperformance.com](http://www.dieselperformance.com)

## 2004-2008 48RE Adjustments

If this adjustment is not made it will void your warranty.

**Do not take this adjustment lightly -- it is very important.**

### ADJUSTMENTS - GEARSHIFT CABLE

Check adjustment by starting the engine in PARK and NEUTRAL. Adjustment is CORRECT if the engine starts only in these positions. Adjustment is INCORRECT if the engine starts in one but not both positions. If the engine starts in any position other than PARK or NEUTRAL, or if the engine will not start at all, the transmission range sensor may be faulty.

#### Gearshift Adjustment Procedure

1. Shift transmission into PARK.
2. Release cable adjuster lock tab (3) (underneath the steering column) to unlock cable.
3. Raise vehicle.
4. Disengage the cable eyelet from the transmission manual shift lever.
5. Verify transmission shift lever is in PARK detent by moving lever fully rearward. Last rearward detent is PARK position.
6. Verify positive engagement of transmission park lock by attempting to rotate propeller shaft. Shaft will not rotate when park lock is engaged.
7. Snap the cable eyelet onto the transmission manual shift lever.
8. Lower vehicle.
9. Lock shift cable by pressing cable adjuster lock tab (3) downward until it snaps into place.
10. Check engine starting. Engine should start only in PARK and NEUTRAL.

#### **\*NOTICE\***

The Transmission Throttle Valve Actuator (TTVA) does not require any mechanical adjustments. All changes in throttle valve position are controlled by the Engine Control Module (ECM). The TTVA does require an initialization period after the actuator has been removed or replaced. After the actuator has been removed or replaced, move the ignition to the ON position for thirty (30) seconds. This will allow the ECM sufficient time to perform the internal calibration procedures to learn the TTVA's current "zero" position. Once this is done, check the ECM for diagnostic trouble codes (DTCs). If no DTCs are set relating to the TTVA, the TTVA is fully calibrated and ready for use.

#### BD Engine Brake Inc.

Plant Address: #A10 – 33733 King Road, Abbotsford, BC, Canada V2S 7M9  
US Shipping: #88 – 446 Harrison St., Sumas, WA, USA 98295 | US Mailing Address: P.O. Box 231, Sumas, WA, USA, 98295  
Phone#: (604) 853-6096 | Fax: (604) 853-8749 | Web: [www.dieselperformance.com](http://www.dieselperformance.com)

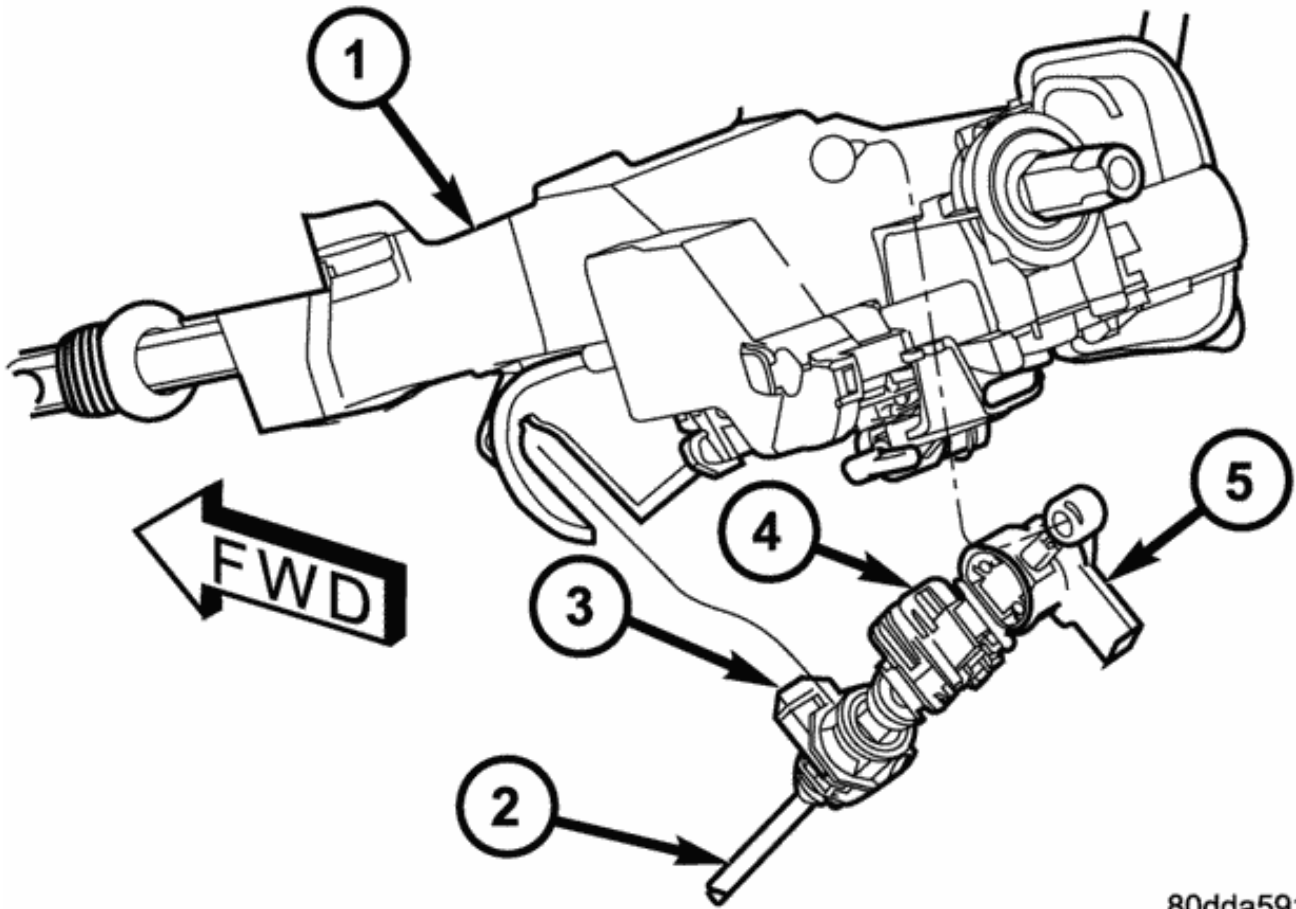

80dda591

1 - STEERING COLUMN
2 - GEARSHIFT CABLE
3 - GEARSHIFT CABLE LOCK TAB
4 - BTSI SOLENOID LOCK TAB
5 - BTSI CONNECTOR

**BD Engine Brake Inc.**

Plant Address: #A10 – 33733 King Road, Abbotsford, BC, Canada V2S 7M9  
US Shipping: #88 – 446 Harrison St., Sumas, WA, USA 98295 | US Mailing Address: P.O. Box 231, Sumas, WA, USA, 98295  
Phone#: (604) 853-6096 | Fax: (604) 853-8749 | Web: [www.dieselperformance.com](http://www.dieselperformance.com)

## ***TRANSMISSION TUNING***

Once the install is completed you can now check the main line pressure. This is accomplished by inserting a fitting and hose assembly with a good quality gauge into the center 1/8" port on the passenger side of the transmission.

### **47RE Transmissions**

<b>Transmission Line Pressure</b>	<b>OEM Pressure</b>	<b>BD Pressure</b>	<b>Test #1</b>	<b>Test #2</b>
Transmission in DRIVE w/Engine at idle	55-65psi	90-110psi		
Transmission in DRIVE w/Convertor Locked up @ WOT	110-120psi	170-180psi		

### **48RE Transmissions**

<b>Transmission Line Pressure</b>	<b>OEM Pressure</b>	<b>BD Pressure</b>	<b>Test #1</b>	<b>Test #2</b>
Transmission in DRIVE w/Engine at idle	55-65psi	90-110psi		
Transmission in DRIVE w/Convertor Locked up @ WOT	110-120psi	170-200psi		

### **Transmission Shift Points**

<b>Transmission Shift Point (RPM)</b>	<b>Before</b>	<b>After</b>
2 <sup>nd</sup> – 3 <sup>rd</sup> Shift point (Normal Driving)		
2 <sup>nd</sup> – 3 <sup>rd</sup> Shift point (Wide Open Throttle)		

***IMPORTANT*** – IF PRESSURES AND/OR SHIFT POINTS ARE NOT TO SPECS, THE TRANSMISSION MUST BE REPAIRED OR SERVICED BEFORE MODIFICATIONS.

***CAUTION*** – PRESSURE SETTINGS THAT ARE TOO HIGH CAN RESULT IN SEVERE SHIFTS, LIMP MODE, or 2<sup>ND</sup> OR 3<sup>RD</sup> GEAR STARTS.

***Transmission / Converter failures require that the remote filter be returned for inspection before any claim is considered, as well you will be required to submit the cooler flow rate in GPM measured at the outlet of the Oil/Air transmission cooler.***

**BD Engine Brake Inc.**

Plant Address: #A10 – 33733 King Road, Abbotsford, BC, Canada V2S 7M9

US Shipping: #88 – 446 Harrison St., Sumas, WA, USA 98295 | US Mailing Address: P.O. Box 231, Sumas, WA, USA, 98295

Phone#: (604) 853-6096 | Fax: (604) 853-8749 | Web: [www.dieselperformance.com](http://www.dieselperformance.com)

## Before you call BD Tech Support

Please ensure you have the following information completed for your specific transmission issue, as the results may be required during the tech call.

### 2-3 STACK SHIFT / 2nd & 3rd GEAR STARTS

- TTVA relearn procedure completed?
- Governor Pressure @ 0 MPH = \_\_\_\_\_
- Governor PSI @ idle? \_\_\_\_\_
- Governor PSI @ 10 MPH? \_\_\_\_\_
- Transmission Governor pressure = Mainline pressure after 2-3 shift? \_\_\_\_\_
- Mainline Pressure = \_\_\_\_\_
- Checked to see if transmission has power? \_\_\_\_\_

### LAZY SHIFT

- Line Pressure @ IDLE = \_\_\_\_\_
- Band adjustment checked? \_\_\_\_\_
- Band adjustment nut turns @ 72 in/lbs = \_\_\_\_\_ (# of turns)

**BD Engine Brake Inc.**

Plant Address: #A10 – 33733 King Road, Abbotsford, BC, Canada V2S 7M9  
US Shipping: #88 – 446 Harrison St., Sumas, WA, USA 98295 | US Mailing Address: P.O. Box 231, Sumas, WA, USA, 98295  
Phone#: (604) 853-6096 | Fax: (604) 853-8749 | Web: [www.dieselperformance.com](http://www.dieselperformance.com)