



Installation Instructions



HOSS™ Cover for 2-Door Wrangler (JK) w/ Window Storage Duffel & Tool Caddy

Product Application

- Jeep® WranglerJK 2 Door Hard Top & Accessories '07-Current
- 42806 / 42805 HOSS™ Top & Door Cart

Part Number: 42807

www.Bestop.com - We're here to help! Visit our web site and click on "Ask a Question" Click here for more [Jeep® Accessories by Bestop](#).

INSTALLATION TIME	SKILL LEVEL
 1/4 Hour	 1 - Easy

TOOLS
 Safety Glasses

 **CAUTION** Safety glasses should be worn at all times while installing this product.

 **WARNING**
This HOSS™ Cover is designed primarily to protect the exterior of a JK Two Door Hard Top unit from ordinary conditions. Please note that during prolonged exposure to heavy rain or snow, some seam leakage may occur. Please plan accordingly. This HOSS™ Cover will not protect the top from falling objects. Never operate vehicle with HOSS™ Cover. The Cover is not made to cover top while vehicle is in tow.



Installation Tips
Before you begin installing the HOSS™ cover & storage accessories, read all instructions thoroughly.

Note:
It is normal for the fabric to contract and wrinkle when stored in the shipping carton. Within a few days after the installation, the fabric will relax and the wrinkles will disappear.

HOSS™ Cover - Installation Instructions

Parts List

2 Door JK HOSS™ Cover	Qty - 1
Window Storage Duffel	Qty - 1
Tool Caddy	Qty - 1

1 Install Cover

Drape Cover over Hardtop unit. Position the darted reinforced areas over corners of the Hardtop shell. Zip the flaps closed.



Note: Before Installation, make sure the Hardtop and items within it are stored securely.

2 Window Storage Duffel

Unroll the Window Storage Duffel to store the various PVC glass components of your Jeep® Soft Top and/or accessories. (Example: Rear and quarter windows, or windjammer). The storage unit has 4 layers of non-woven fabric developed to protect the glass from chemical reaction.

After inserting glass components tuck them under the side flaps and secure the side straps. Roll the storage unit up to the straps and insert web into the buckles.

The web straps can be secured onto the door cart shown below or to the sport bars of the Jeep®.

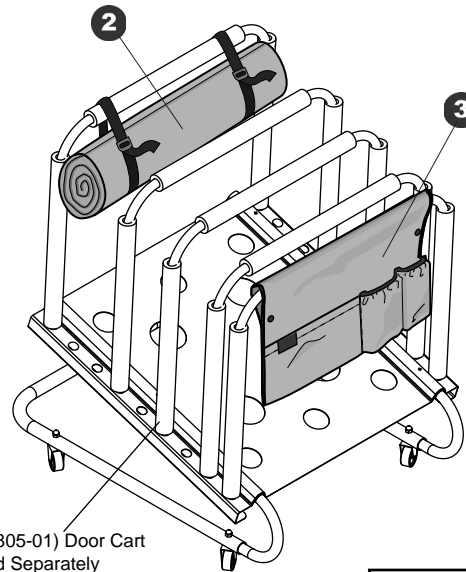
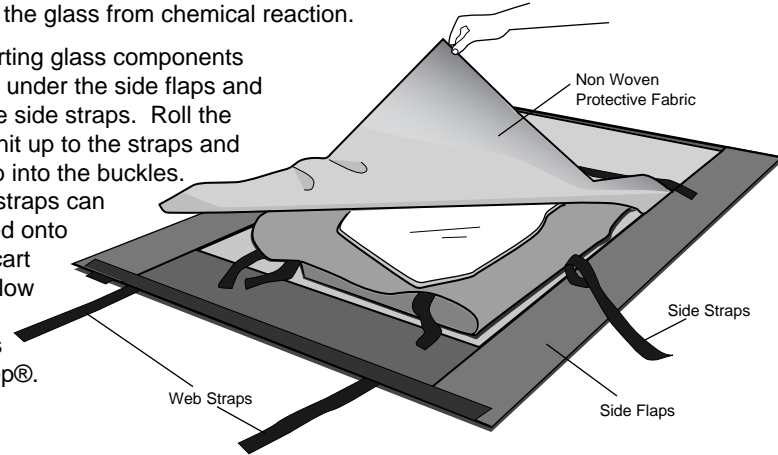

(42805-01) Door Cart Sold Separately

3 Tool Caddy

The Tool Caddy was developed to store various tools and cleaning supplies needed for your Jeep® soft top and/or accessories. This attaches to the bars of the HOSS door cart (42805-01), shown to the left. If you do not have a door cart, this can work with another similar bar or hung on the wall as shown below.

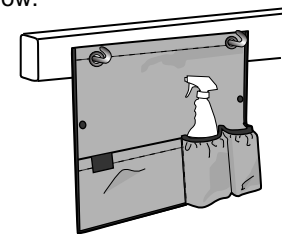

Special Note: The Caddy is great for storing the Bestop® cleaner (11201) and protectant (11202)



HOSS™ Cover - Installation Instructions

Care and Maintenance of your New Storage

Your products are made of the finest materials available. To keep it looking new and for the maximum possible wear, it will need periodic cleaning and maintenance.

Washing: The fabric should be washed often using soap, warm water and a soft bristle brush. Rinse with clear water to remove all traces of soap.

Zippers: Keeping the zipper cleaned and lubricated with a silicone lubricant will help prevent damage and keep the zippers in a smooth working condition. If a zipper opens behind the slider, the slider may have been spread apart. This problem can usually be repaired by using an ordinary pair of pliers to bring the sides back into parallel. Return slider to the end of the zipper in the normal Open position. Squeeze lightly at first and test the zipper. If the zipper continues to remain open squeeze more firmly with the pliers and try the zipper again. Repeat this procedure until the zipper operates correctly.

Water: In the event of seeping through the seams, 3M Scotchgard® may be applied on the inside of the seams to stop the seepage. Rips in the fabric may be repaired with Bondex® iron on patches. Iron the patches to the Inside of the covers, carefully following the Bondex® instructions.

Snaps: Keep snaps cleaned and lubricated with silicone to help prevent snaps from sticking to the studs. If a snap does become stuck to a stud, use a screwdriver and GENTLY pry apart to prevent permanent damage to the snap or the fabric.

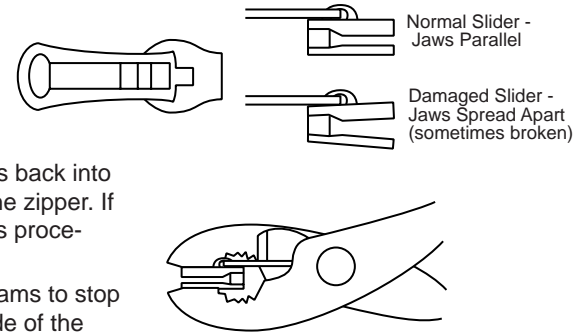

Limited Warranty

We warrant our product to be free from defects in material and workmanship, for the terms specified below, provided there has been normal use and proper maintenance. This warranty applies to the original purchaser only. All remedies under this warranty are limited to the repair or replacement of any item or items found by the factory to be defective within the time period specified.

If you have a warranty claim, first you must call our factory at the number below for instructions. You must retain proof of purchase and submit a copy with any items returned for warranty work. Upon completion of warranty work, if any, we will return the repaired or replaced item or items to you freight prepaid. Damage to our products caused by accidents, fire, vandalism, negligence, misinstallation, misuse, Acts of God, or by defective parts not manufactured by us, is not covered under this warranty.

THE WARRANTY TIME PERIOD IS AS FOLLOWS: ALL "SOFT GOODS" MANUFACTURED BY OUR COMPANY (USING PRIMARILY VINYL, PLASTICS, AND/OR FOAM): ONE YEAR FROM DATE OF PURCHASE.

ANY IMPLIED WARRANTIES OF MERCHANTABILITY AND/OR FITNESS FOR A PARTICULAR PURPOSE CREATED HEREBY ARE LIMITED IN DURATION TO THE SAME DURATION AND SCOPE AS THE EXPRESS WRITTEN WARRANTY. OUR COMPANY SHALL NOT BE LIABLE FOR ANY INCIDENTAL OR CONSEQUENTIAL DAMAGE.

Some states do not allow limitations on how long an implied warranty lasts, or the exclusion or limitation of incidental or consequential damages, so the above limitations or exclusions may not apply to you.

This warranty gives you specific legal rights, and you may also have other rights which vary from state to state.



For further information or request for warranty work, please contact:

Bestop Inc. Customer Service

(800) 845-3567

(303) 465-1755

* All or a portion of this product may be made in China