







# Installation Instructions HighRock 4x4™ Bumper Storage Box

## Vehicle Application:

- Fits HighRock 4x4™ Bumpers 42901, 42908 and 42910
- Part Number: 42909

[www.Bestop.com](http://www.Bestop.com) - We're here to help! Visit our web site and click on "[Ask a Question](#)". Click here for more [Jeep® Accessories by Bestop](#).

INSTALLATION TIME	SKILL LEVEL
 1/4 Hour	<b>1</b> <input type="radio"/> 2 <input type="radio"/> 3 <input type="radio"/> 4 <input type="radio"/> 1 - Easy

TOOLS			
 Adjustable Wrench Qty - 2	 Metal File	 Hammer	 Safety Glasses



**⚠ WARNING** This product is designed primarily to enhance the appearance of the vehicle. Do not rely in any way on the components of this product to protect against injury or death in the event of an accident. Never operate the vehicle in excess of manufacturer's specifications.

### WEAR SEAT BELTS AT ALL TIMES

Read and follow, precisely, all installation instructions provided when installing product. Failure to do so may result in a poor fit and could place occupants of the vehicle in a potentially dangerous situation.

# HighRock 4x4™ Bumper Storage Box Installation Instructions

## Parts List

Bumper Box Lid, Qty - 1



Bumper Box, Qty - 1

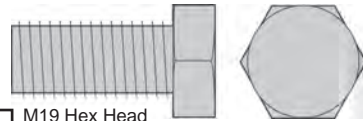
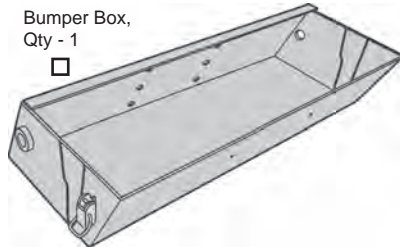

M19 Hex Head Bolt, Qty - 2

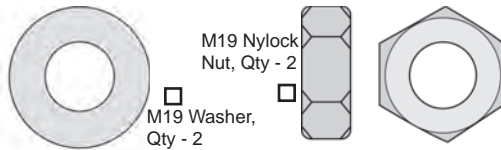

M19 Nylock Nut, Qty - 2

M19 Washer, Qty - 2

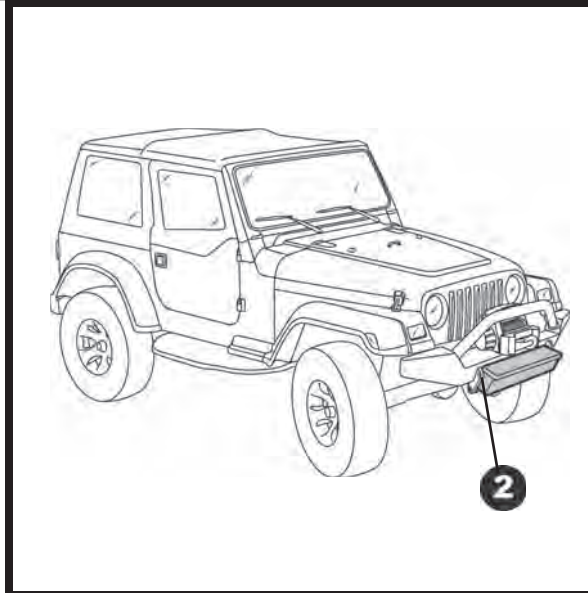

## 2 Install Box on Bumper

Use the M19 Hex Bolts, M19 Washers and M19 Nylock Nuts to mount the Bumper Box to the bumper.

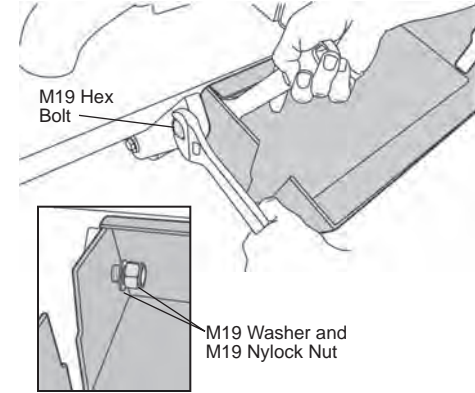

## 1 Prepare for a Hi-Lift Jack – Optional

If you are using the Bumper Box to carry a Hi-Lift Jack, use a hammer to knock out the Hi-Lift Jack profile in the Bumper Box. File any sharp edges.

If you are not using a Hi-Lift Jack, do not knock out the profile.

If using a Hi-Lift Jack – Knock out profiles

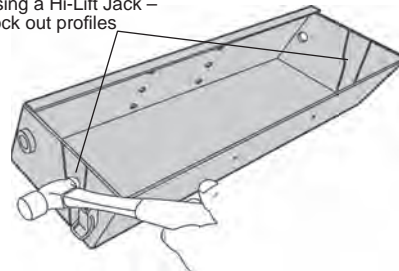

## 3 Install Hi-Lift Jack – Optional

If you are using the Bumper Box to carry a Hi-Lift Jack, place the jack in the knock out. Make sure to slide the large side of the jack in as far as possible.

Slide as far in as possible

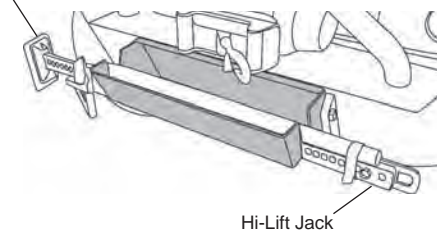

## HighRock 4x4™ Bumper Storage Box Installation Instructions

### 4 Install Bumper Box Lid

Install the Bumper Box Lid and secure the latches on each side.

**NOTE** The Bumper Box latches may be locked with a padlock (not included).

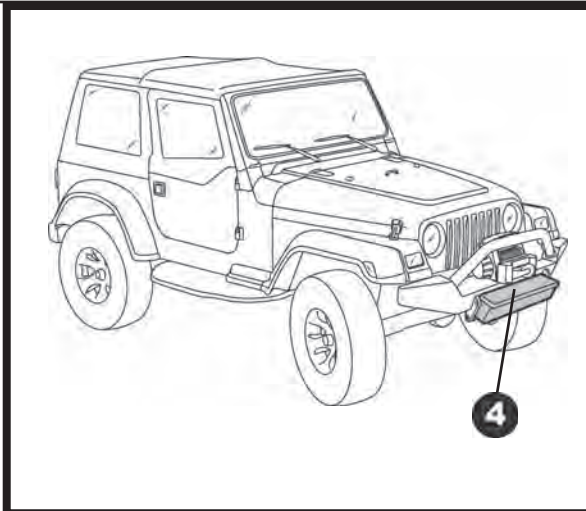
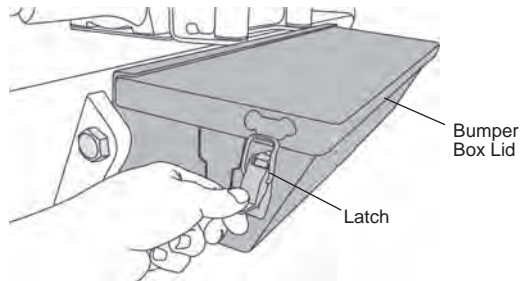

## LIMITED WARRANTY

We warrant our product to be free from defects in material and workmanship, for the terms specified below, provided there has been normal use and proper maintenance. This warranty applies to the original purchaser only. All remedies under this warranty are limited to the repair or replacement of any item or items found by the factory to be defective within the time period specified. If you have a warranty claim, first you must call our factory at the number below for instructions. You must retain proof of purchase and submit a copy with any items returned for warranty work. Upon completion of warranty work, if any, we will return the repaired or replaced item or items to you freight prepaid. Damage to our products caused by accidents, fire, vandalism, negligence, misinstallation, misuse, Acts of God, or by defective parts not manufactured by us, is not covered under this warranty.

THE WARRANTY TIME PERIOD IS AS FOLLOWS FOR REPLACE-A-TOP™, SAILCLOTH REPLACE-A-TOP™, SUPERTOP®, SUPERTOP® REPLACEMENT SKINS, SUNRIDER®, AND TIGERTOP®: TWO YEARS FROM DATE OF PURCHASE.

THE WARRANTY TIME PERIOD IS AS FOLLOWS FOR ALL OTHER "SOFT GOODS" MANUFACTURED BY OUR COMPANY (USING PRIMARILY VINYL, PLASTICS, AND/OR FOAM): ONE YEAR FROM DATE OF PURCHASE.

THE WARRANTY TIME PERIOD IS AS FOLLOWS FOR ALL OTHER "HARD GOODS" MANUFACTURED BY OUR COMPANY (USING PRIMARILY METALS, PLASTICS, AND/OR FIBERGLASS): ONE YEAR FROM DATE OF PURCHASE.

ANY IMPLIED WARRANTIES OF MERCHANTABILITY AND/OR FITNESS FOR A PARTICULAR PURPOSE CREATED HEREBY ARE LIMITED IN DURATION TO THE SAME DURATION AND SCOPE AS THE EXPRESS WRITTEN WARRANTY. OUR COMPANY SHALL NOT BE LIABLE FOR ANY INCIDENTAL OR CONSEQUENTIAL DAMAGE.

Some states do not allow limitations on how long an implied warranty lasts, or the exclusion or limitation of incidental or consequential damages, so the above limitations or exclusions may not apply to you. This warranty gives you specific legal rights, and you may also have other rights which vary from state to state.



For further information or request for warranty work, please contact:

Bestop Inc. Customer Service  
Toll-Free: (800)845-3567  
Main: (303)465-1755  
E-mail: [csbestop@Bestop.com](mailto:csbestop@Bestop.com)  
Website: [www.Bestop.com](http://www.Bestop.com)