







Installation Instructions HighRock 4x4™ Rocker Trim and Door Handle Recess Guard

Vehicle Application:

- Jeep JK Wrangler Unlimited 4 Door
2007 – Current
Part Number: 42951

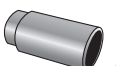
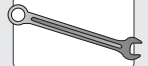
www.Bestop.com - We're here to help! Visit our web site and click on "[Ask a Question](#)". Click here for more [Jeep® Accessories by Bestop](#).

INSTALLATION TIME	SKILL LEVEL		
 1/2 Hour	 1 - Easy		
TOOLS			
 Ratchet	 Socket 10mm	 Wrench 10mm	 50/50 Solution Alcohol/Water
 Safety Glasses			



⚠ WARNING This product is designed primarily to enhance the appearance of the vehicle. Do not rely in any way on the components of this product to protect against injury or death in the event of an accident. Never operate the vehicle in excess of manufacturer's specifications.

WEAR SEAT BELTS AT ALL TIMES

Read and follow, precisely, all installation instructions provided when installing product. Failure to do so may result in a poor fit and could place occupants of the vehicle in a potentially dangerous situation.

HighRock 4x4™ Rocker Trim Installation Instructions

Parts List and Hardware Identification

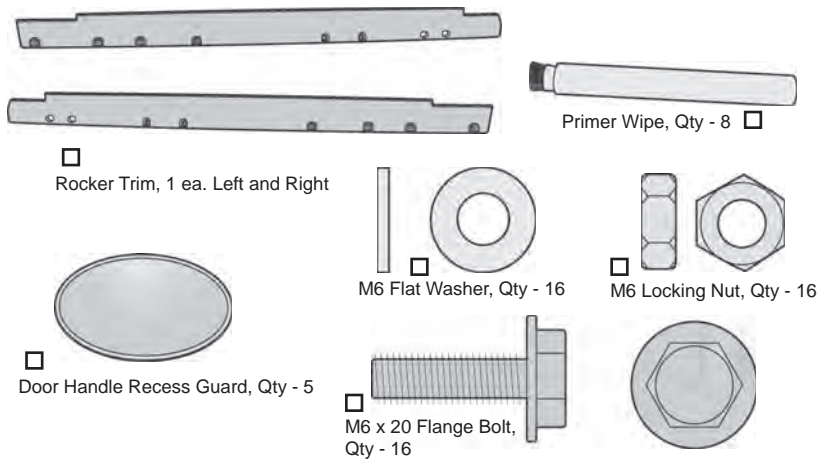

2 Clean Rocker Panel

Orient the Rocker Trim on the vehicle. Without removing the backing tape, place one of the trim pieces against the rocker panel to check the alignment and fit.

Clean the rocker panel area with a 50/50 solution of water and alcohol and a soft cloth to remove any grease or dirt.

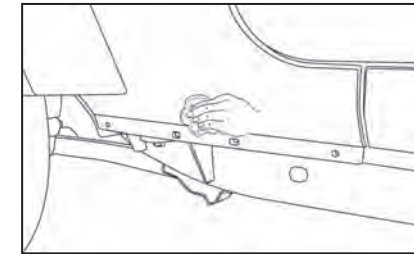
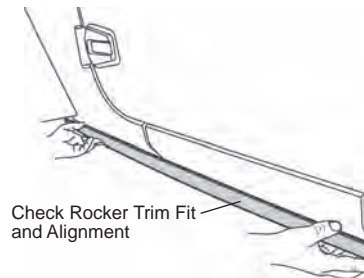

NOTE For best results, this product should be installed in a shaded area with the rocker panel cool to the touch.

1 Remove Existing Bolts

Use a 10mm socket to remove the existing two (2) bolts from the rocker panel and discard them.

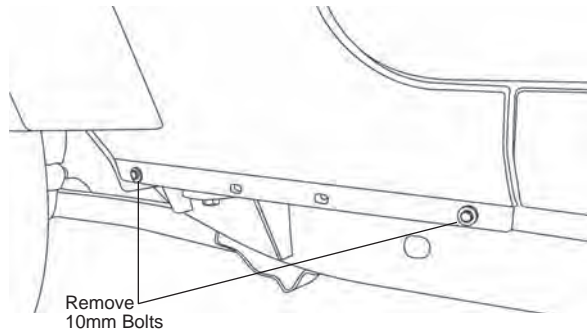

3 Primer Rocker Panel

Locate the position of the adhesive strips on the inside of the Rocker Trim. Wipe the areas on the rocker panel that correspond to these locations with the Primer Wipe in the parts kit.

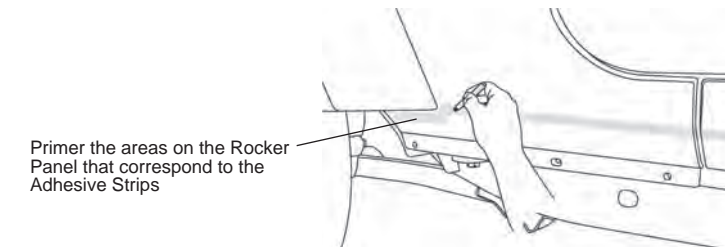

HighRock 4x4™ Rocker Trim Installation Instructions

4 Install Rocker Trim

Peel all the backing tape off the adhesive on the Rocker Trim.

Use two (2) of the M6 x 20 Flange Bolts to help align the holes in the Rocker Trim with the holes in the panel and place the Trim against the panel. Push the Trim snug against the vehicle. When the Rocker Trim is in the proper position apply firm pressure.

NOTE Once the adhesive on the Rocker Trim makes contact with the rocker panel, you have 10 seconds to adjust the position of the Trim.

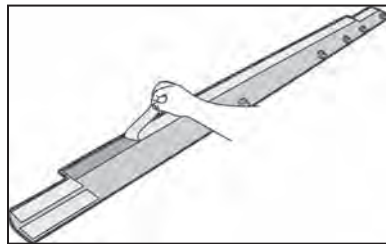

Peel Backing Tape off Adhesive

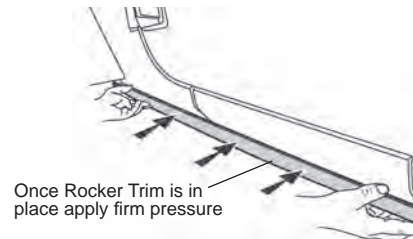

Once Rocker Trim is in place apply firm pressure

6 Clean Door Handle Recess

Clean the door handle recess with a 50/50 solution of water and alcohol and a soft cloth to remove any grease or dirt.

Locate the position of the adhesive strips on the back of the Door Handle Recess Guard. Wipe the areas of the door handle recess that correspond to these locations with the Primer Wipe in the parts kit.

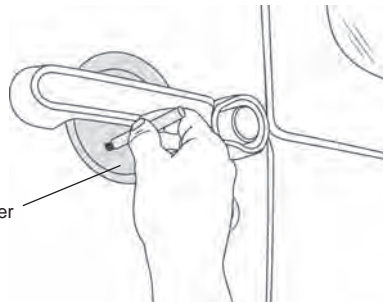

Clean Recess with Alcohol / Water Solution then Primer

5 Secure Rocker Trim

Install an M6 x 20 Flange Bolt in the two holes where the original bolts were removed to secure the Rocker Trim to the rocker panel. Then install an M6 x 20 Flange Bolt with an M6 Flat Washer and an M6 Locking Nut in each of the remaining holes.

Repeat steps 1 – 5 on the other side of the vehicle.

NOTE If you are installing the Rocker Trim on a 2 Door Vehicle, you will not use two (2) of the Bolt, Washer, Nut assemblies on each side of the vehicle so you will have four (4) M6 x 20 Flange Bolts, four (4) M6 Washers and four (4) M6 Locking Nuts left over.

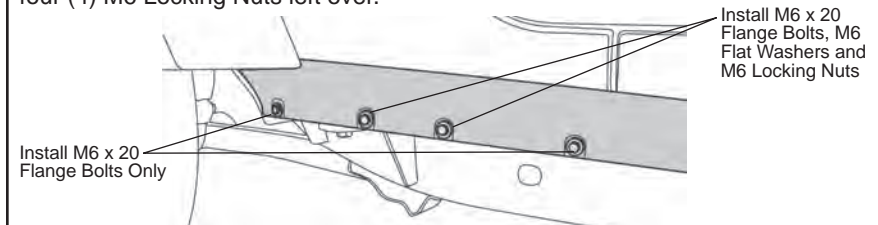

Install M6 x 20 Flange Bolts, M6 Flat Washers and M6 Locking Nuts

7 Install Door Handle Recess Guard

Peel all the backing tape off the adhesive on the Door Handle Recess Guard.

Place the Door Handle Recess Guard in the door handle recess and push it snug against the vehicle. When the guard is in the proper position apply firm pressure.

Repeat for the remaining doors and the tailgate.

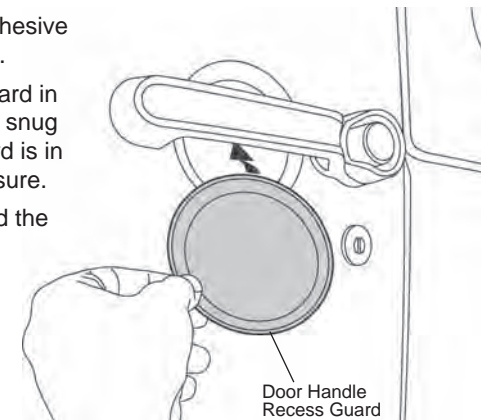

Door Handle Recess Guard

NOTE The adhesive requires 24 hours to fully set and bond to the vehicle.

HighRock 4x4™ Rocker Trim Installation Instructions

LIMITED WARRANTY

We warrant our product to be free from defects in material and workmanship, for the terms specified below, provided there has been normal use and proper maintenance. This warranty applies to the original purchaser only. All remedies under this warranty are limited to the repair or replacement of any item or items found by the factory to be defective within the time period specified. If you have a warranty claim, first you must call our factory at the number below for instructions. You must retain proof of purchase and submit a copy with any items returned for warranty work. Upon completion of warranty work, if any, we will return the repaired or replaced item or items to you freight prepaid. Damage to our products caused by accidents, fire, vandalism, negligence, misinstallation, misuse, Acts of God, or by defective parts not manufactured by us, is not covered under this warranty.

THE WARRANTY TIME PERIOD IS AS FOLLOWS FOR REPLACE-A-TOP™, SAILCLOTH REPLACE-A-TOP™, SUPERTOP®, SUPERTOP® REPLACEMENT SKINS, SUNRIDER®, AND TIGERTOP®: TWO YEARS FROM DATE OF PURCHASE.

THE WARRANTY TIME PERIOD IS AS FOLLOWS FOR ALL OTHER “SOFT GOODS” MANUFACTURED BY OUR COMPANY (USING PRIMARILY VINYL, PLASTICS, AND/OR FOAM): ONE YEAR FROM DATE OF PURCHASE.

THE WARRANTY TIME PERIOD IS AS FOLLOWS FOR ALL OTHER “HARD GOODS” MANUFACTURED BY OUR COMPANY (USING PRIMARILY METALS, PLASTICS, AND/OR FIBERGLASS): ONE YEAR FROM DATE OF PURCHASE.

ANY IMPLIED WARRANTIES OF MERCHANTABILITY AND/OR FITNESS FOR A PARTICULAR PURPOSE CREATED HEREBY ARE LIMITED IN DURATION TO THE SAME DURATION AND SCOPE AS THE EXPRESS WRITTEN WARRANTY. OUR COMPANY SHALL NOT BE LIABLE FOR ANY INCIDENTAL OR CONSEQUENTIAL DAMAGE.

Some states do not allow limitations on how long an implied warranty lasts, or the exclusion or limitation of incidental or consequential damages, so the above limitations or exclusions may not apply to you. This warranty gives you specific legal rights, and you may also have other rights which vary from state to state.



For further information or request for warranty work, please contact:
Bestop Inc. Customer Service
Toll-Free: (800)845-3567
Main: (303)465-1755
E-mail: csbestop@Bestop.com
Website: www.Bestop.com