



# Installation Instructions



## HighRock 4x4™ Fender Flares





### Vehicle Application:

- Jeep CJ-5, CJ-6 & CJ-7  
1995 - 1986  
Part Number: 49253
- Jeep Wrangler  
1986 - 1995  
Part Number: 49252

- Jeep Wrangler and  
Wrangler Unlimited  
1997 - 2006  
Part Number: 49251

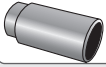
[www.Bestop.com](http://www.Bestop.com) - We're here to help! Visit our web site and click on "[Ask a Question](#)". Click here for more [Jeep® Accessories by Bestop](#).

INSTALLATION TIME	SKILL LEVEL
 1/2 Hour	 2 - Moderately Easy

TOOLS			
 Socket 3/8" and 5/16"	 Ratchet	 Power Drill 1/4" Bit (CJs Only)	 Safety Glasses



DO NOT INSTALL THIS PRODUCT ON ANY VEHICLE OTHER THAN THOSE LISTED ABOVE. This product is only designed for the vehicles listed above. Failure to install this product on the proper vehicle could cause injury to the vehicle occupants and damage to the product.

**! WARNING** This product is designed primarily to enhance the appearance of the vehicle and to shield the occupants from ordinary weather conditions. Do not rely in any way on the components of this product to contain occupants within the vehicle, or to protect against injury or death in the event of an accident. This product will not protect the occupants from falling objects. Never operate the vehicle in excess of manufacturer's specifications.

### WEAR SEAT BELTS AT ALL TIMES

Read and follow, precisely, all installation instructions provided when installing product. Failure to do so may result in a poor fit and could place occupants of the vehicle in a potentially dangerous situation.

# HighRock 4x4™ Fender Flare Installation Instructions

## Parts List and Hardware Identification

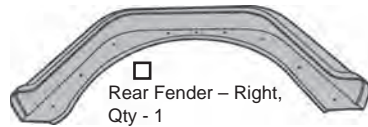
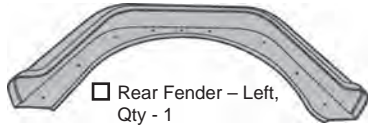
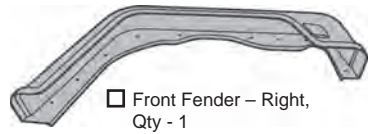
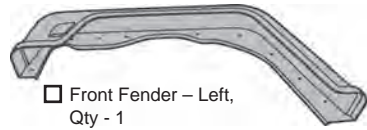

For YJ Vehicles Only (49252)

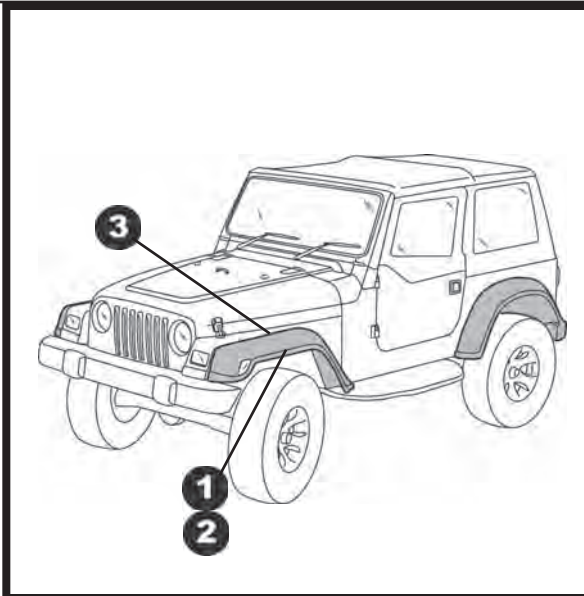
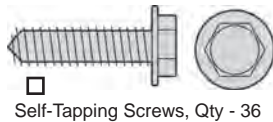
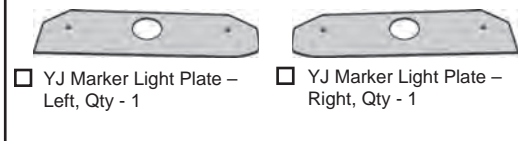

## 1 Remove Existing Fender Flares

Disconnect and remove any lights that are connected to the existing fender flares. Set them aside to be reinstalled later.

Remove the fender flares. Set the factory machine thread screws aside for later use.

## 2 Orient Fender Flare to Vehicle

Select one of the Front Fender Flares and lay it against the vehicle to check alignment and fit.

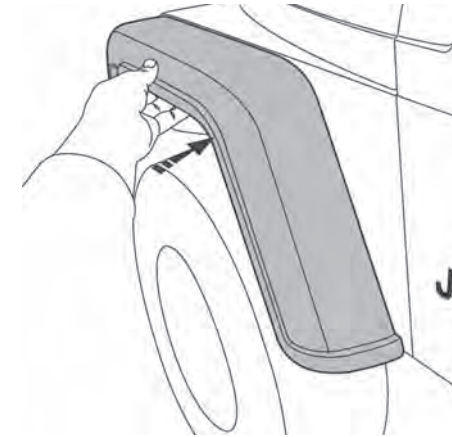

## 3 Drill Holes – CJ Vehicles Only (49253)

If your vehicle does not have holes in the body from pre-existing fender flares, use the holes in the flare to mark and drill 1/4" holes in the body.

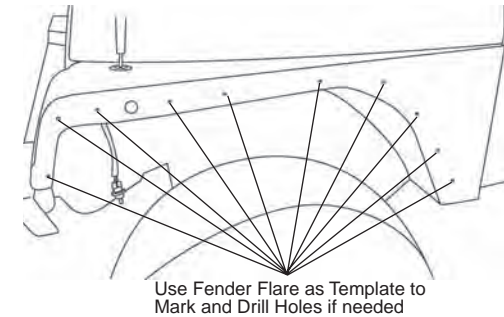

# HighRock 4x4™ Fender Flare Installation Instructions

## 4 Install Foam Tape

Align the Foam Tape with the radius along the mounting face of the Fender Flare. Peel the backing off the tape a little at a time and press it firmly onto the Fender Flare. Trim any excess tape.

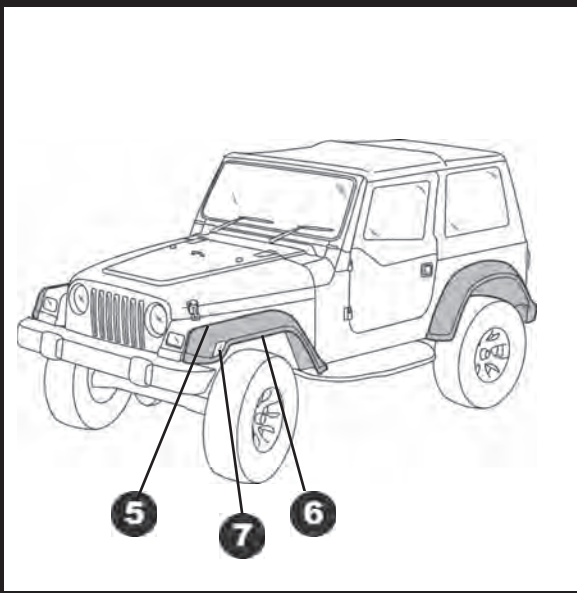
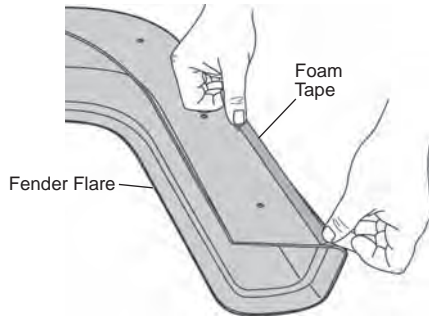

## 7 Reinstall Side Marker Light

Reinstall the light removed in Step 1.

## 8 Install Remaining Fender Flares

Repeat this procedure with the remaining Fender Flares.

## 5 Install YJ Marker Light Plate – YJ Vehicles Only (49252)

Peel the backing tape off the YJ Marker Light Plate. Align the large hole in the plate with the round hole in the vehicle below the hood latch and the smaller holes with the installation holes on either side. Press the plate firmly against the vehicle.

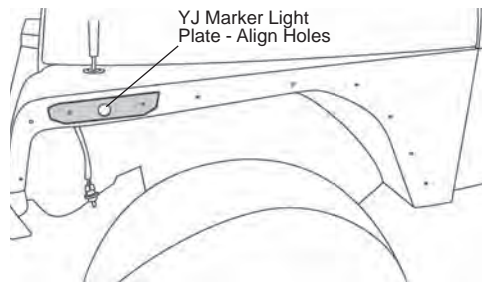

## 6 Install Fender Flare

Use the factory machine thread screws that were removed in Step 1 to mount the Fender Flare to the vehicle. Use the Self-Tapping Screws provided for the remainder of the holes.

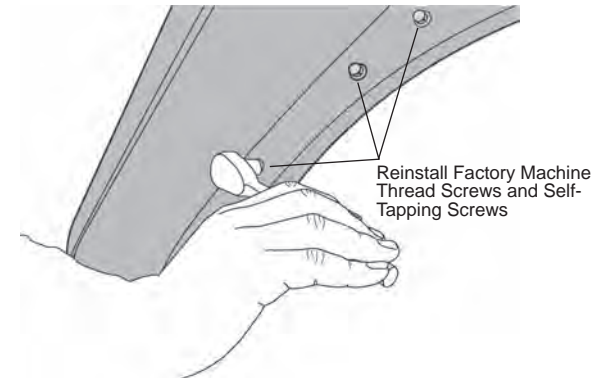

## HighRock 4x4™ Fender Flare Installation Instructions

---

### LIMITED WARRANTY

We warrant our product to be free from defects in material and workmanship, for the terms specified below, provided there has been normal use and proper maintenance. This warranty applies to the original purchaser only. All remedies under this warranty are limited to the repair or replacement of any item or items found by the factory to be defective within the time period specified. If you have a warranty claim, first you must call our factory at the number below for instructions. You must retain proof of purchase and submit a copy with any items returned for warranty work. Upon completion of warranty work, if any, we will return the repaired or replaced item or items to you freight prepaid. Damage to our products caused by accidents, fire, vandalism, negligence, misinstallation, misuse, Acts of God, or by defective parts not manufactured by us, is not covered under this warranty.

THE WARRANTY TIME PERIOD IS AS FOLLOWS FOR REPLACE-A-TOP™, SAILCLOTH REPLACE-A-TOP™, SUPERTOP®, SUPERTOP® REPLACEMENT SKINS, SUNRIDER®, AND TIGERTOP®: TWO YEARS FROM DATE OF PURCHASE.

THE WARRANTY TIME PERIOD IS AS FOLLOWS FOR ALL OTHER “SOFT GOODS” MANUFACTURED BY OUR COMPANY (USING PRIMARILY VINYL, PLASTICS, AND/OR FOAM): ONE YEAR FROM DATE OF PURCHASE.

THE WARRANTY TIME PERIOD IS AS FOLLOWS FOR ALL OTHER “HARD GOODS” MANUFACTURED BY OUR COMPANY (USING PRIMARILY METALS, PLASTICS, AND/OR FIBERGLASS): ONE YEAR FROM DATE OF PURCHASE.

ANY IMPLIED WARRANTIES OF MERCHANTABILITY AND/OR FITNESS FOR A PARTICULAR PURPOSE CREATED HEREBY ARE LIMITED IN DURATION TO THE SAME DURATION AND SCOPE AS THE EXPRESS WRITTEN WARRANTY. OUR COMPANY SHALL NOT BE LIABLE FOR ANY INCIDENTAL OR CONSEQUENTIAL DAMAGE.

Some states do not allow limitations on how long an implied warranty lasts, or the exclusion or limitation of incidental or consequential damages, so the above limitations or exclusions may not apply to you. This warranty gives you specific legal rights, and you may also have other rights which vary from state to state.



For further information or request for warranty work, please contact:

Bestop Inc., Customer Service

Toll-Free: (800)845-3567

Main: (303)465-1755

E-mail: [csbestop@Bestop.com](mailto:csbestop@Bestop.com)

Website: [www.Bestop.com](http://www.Bestop.com)