







Installation Instructions HighRock 4x4™ Element™ Lower Door Frame

Vehicle Application

- Jeep TJ Wrangler and Wrangler Unlimited
1997-2006
Part Number: 51809

www.Bestop.com - We're here to help! Visit our web site and click on ["Ask a Question"](#). Click here for more [Jeep Accessories by Bestop](#).

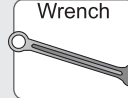
INSTALLATION TIME	SKILL LEVEL
 1/2 Hour	<div style="display: flex; justify-content: space-around;"> <div style="border: 1px solid black; border-radius: 50%; width: 30px; height: 30px; text-align: center; line-height: 30px;">1</div> <div style="border: 1px solid black; border-radius: 50%; width: 30px; height: 30px; text-align: center; line-height: 30px;">2</div> <div style="border: 1px solid black; border-radius: 50%; width: 30px; height: 30px; text-align: center; line-height: 30px;">3</div> <div style="border: 1px solid black; border-radius: 50%; width: 30px; height: 30px; text-align: center; line-height: 30px;">4</div> </div> 1 - Easy

TOOLS			
 Safety Glasses	 Phillips Screwdriver	 Wrench 7/16" and 3/8"	 Allen Wrench
 Torx Wrench T-50			





Installation Tips

Before you begin installing this assembly, read all instructions thoroughly.

For a smooth fit:

For ease in installation, the product should be installed at temperatures above 72° F. Below this temperature, the fabric may contract an inch or more, making it difficult to fit to the vehicle. It is normal for fabric to contract and wrinkle when stored in the shipping carton. Within a few days after the installation, the fabric will relax and the wrinkles will disappear.

 **CAUTION** Safety glasses should be worn at all times while installing this product.

 **WARNING** This product is designed primarily to enhance the appearance of the vehicle and to shield the occupants from ordinary weather conditions. Do not rely in any way on the components of this product to contain occupants within the vehicle, or to protect against injury or death in the event of an accident. This product will not protect the occupants from falling objects. Never operate the vehicle in excess of manufacturer's specifications.

WEAR SEAT BELTS AT ALL TIMES

Read and follow, precisely, all installation instructions provided when installing product. Failure to do so may result in a poor fit and could place occupants of the vehicle in a potentially dangerous situation.

HighRock 4x4™ Element™ Lower Door Frame – Installation Instructions

Parts List

Right Door Frame, Part Number 422.12 Qty - 1
 Left Door Frame, Part Number 422.00 Qty - 1



□ Dome Light Switch Bracket, Qty - 2, 454.52

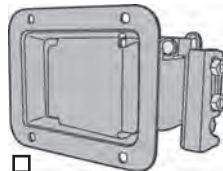

□ Latches, Rotary Paddle Handle, Left - Qty - 1, 454.43
 Right - Qty - 1, 454.42



□ Door Restraint Straps, Qty - 2, Part Number 393.23

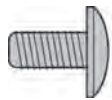

□ #10-32 Truss Head Machine Screw - Black, Qty - 8, Part Number 316.82



□ #10-32 Low Profile Nut - Black, Qty - 8, Part Number 316.94

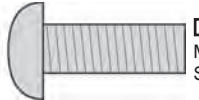

□ M6 x 10 Button Head Screw, Qty - 4

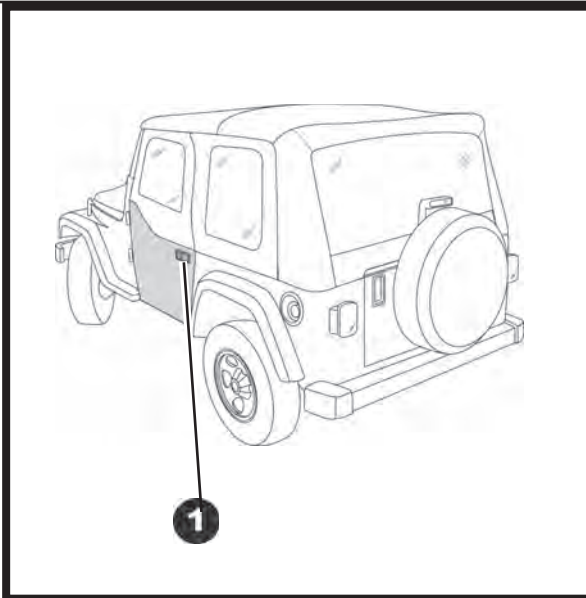

WARNING

It is important that the Paddle Handle must align correctly with the automobile manufacturer's original equipment steel latch pin located on the vehicle. Failure to properly install the paddle handle may result in the door accidentally opening. **IMPROPER CLOSURE COULD RESULT IN SERIOUS INJURY OR DEATH TO THE OCCUPANTS. WEAR SEAT BELTS AT ALL TIMES. DRIVE CAREFULLY.**



WARNING

The Element Door System is equipped for protection against the elements. The door will not contain occupants during an accident. **Wear Seatbelts at all times**

IMPORTANT: You should check alignment of the Paddle Handle to the steel latch pin before tightening the screws. If out of alignment, align and retighten the screws securely. Repeat for both lower doors.



1 Install Paddle Handle

Insert the Paddle Handle into the mounting plate so that the latch mechanism is inside of the vehicle and the Rotary Latch Mechanism is toward the rear of the door. Align the four holes in the Paddle Handle Assembly with the four holes in the mounting plate. Insert four #10-32 Truss Head Machine Screws from the outside and secure them with #10-32 Locknuts. Do not tighten the screws until all four are in place.

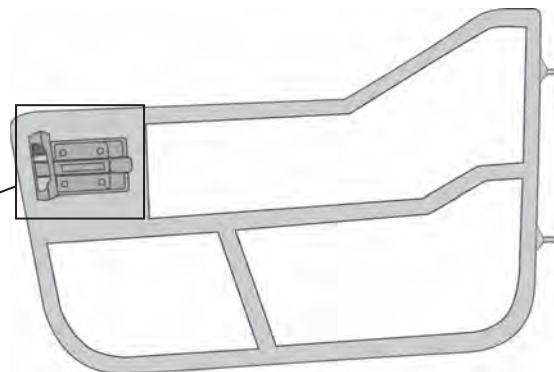
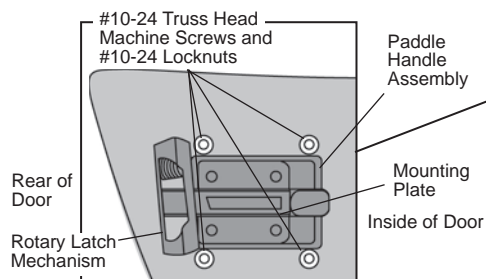

HighRock 4x4™ Element™ Lower Door Frame – Installation Instructions

2 Install Door

Hold the door straight out from the vehicle with the hinge pins over the body hinges. Lower the pins into the hinges. Make sure that the pins are fully inserted into the body hinges. Adjust the factory hinges and latch pin if necessary to ensure the latch engages securely.

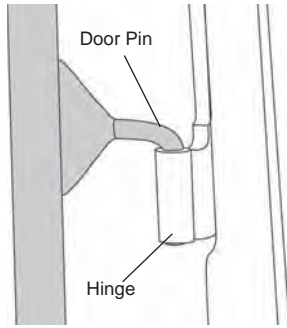

NOTE If the Element door does not match up with the door striker, you may adjust the door striker by loosening it with a T-50 torx wrench and either lowering or raising the door striker. Tighten the door striker securely after adjusting. The door striker will have to be put back into its original position to reinstall O.E. doors

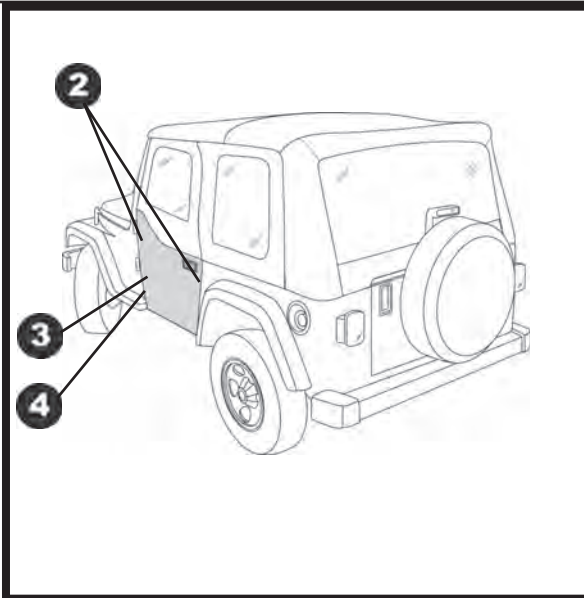

4 Install Restraint Strap

Locate a Door Restraint Strap in the small parts kit. Slip the loop in one over the hook on the door frame. Slip the loop in the other end onto the hook on the vehicle body.

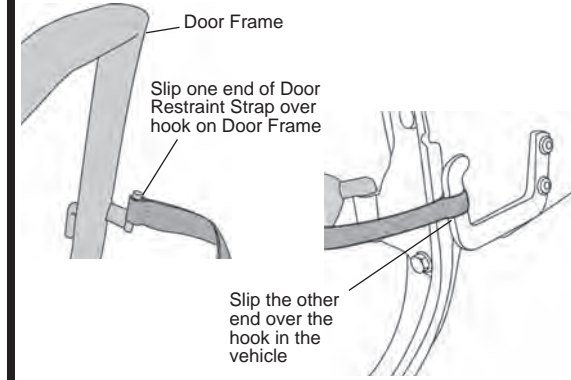

3 Install Dome Light Switch Bracket

Locate the Dome Light Switch on the vehicle. Mount the Dome Light Switch Bracket to the Door in that location. Adjust the bracket location so that the dome light turns off when the Door is closed. Repeat on both sides of the vehicle.

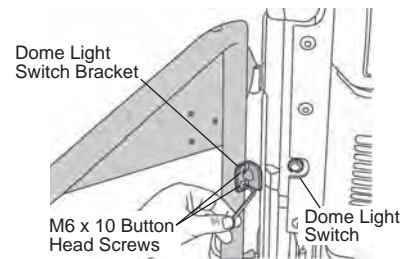

HighRock 4x4™ Element™ Lower Door Frame – Installation Instructions

LIMITED WARRANTY

We warrant our product to be free from defects in material and workmanship, for the terms specified below, provided there has been normal use and proper maintenance. This warranty applies to the original purchaser only. All remedies under this warranty are limited to the repair or replacement of any item or items found by the factory to be defective within the time period specified. If you have a warranty claim, first you must call our factory at the number below for instructions. You must retain proof of purchase and submit a copy with any items returned for warranty work. Upon completion of warranty work, if any, we will return the repaired or replaced item or items to you freight prepaid. Damage to our products caused by accidents, fire, vandalism, negligence, misinstallation, misuse, Acts of God, or by defective parts not manufactured by us, is not covered under this warranty.

THE WARRANTY TIME PERIOD IS AS FOLLOWS FOR REPLACE-A-TOP™, SAILCLOTH REPLACE-A-TOP™, SUPERTOP®, SUPERTOP® REPLACEMENT SKINS, SUNRIDER®, AND TIGERTOP®: TWO YEARS FROM DATE OF PURCHASE.

THE WARRANTY TIME PERIOD IS AS FOLLOWS FOR ALL OTHER “SOFT GOODS” MANUFACTURED BY OUR COMPANY (USING PRIMARILY VINYL, PLASTICS, AND/OR FOAM): ONE YEAR FROM DATE OF PURCHASE.

THE WARRANTY TIME PERIOD IS AS FOLLOWS FOR ALL OTHER “HARD GOODS” MANUFACTURED BY OUR COMPANY (USING PRIMARILY METALS, PLASTICS, AND/OR FIBERGLASS): ONE YEAR FROM DATE OF PURCHASE.

ANY IMPLIED WARRANTIES OF MERCHANTABILITY AND/OR FITNESS FOR A PARTICULAR PURPOSE CREATED HEREBY ARE LIMITED IN DURATION TO THE SAME DURATION AND SCOPE AS THE EXPRESS WRITTEN WARRANTY. OUR COMPANY SHALL NOT BE LIABLE FOR ANY INCIDENTAL OR CONSEQUENTIAL DAMAGE.

Some states do not allow limitations on how long an implied warranty lasts, or the exclusion or limitation of incidental or consequential damages, so the above limitations or exclusions may not apply to you. This warranty gives you specific legal rights, and you may also have other rights which vary from state to state.



For further information or request for warranty work, please contact:

Bestop Inc., Customer Service

Toll-Free: (800) 845-3567

Main: (303) 465-1755

E-mail: csbestop@Bestop.com

Website: www.Bestop.com

*All or a portion of this product may be made in China or South Africa.