





Installation Instructions Headliner



For Original Equipment Soft Top and
Bestop Supertop

Vehicle Application

- Jeep JK Wrangler Unlimited
2007 – Current
Part Number: 51816

www.Bestop.com - We're here to help! Visit our web site and click on ["Ask a Question"](#). Click here for more [Jeep Accessories by Bestop](#).

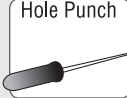
INSTALLATION TIME	SKILL LEVEL
 1 Hour	 2 - Moderately Easy

TOOLS		
 Phillips Screwdriver	 Hole Punch	 Safety Glasses



 **CAUTION** Safety glasses should be worn at all times while installing this product.

Installation Tips

Before you begin installing this assembly, read all instructions thoroughly.

For a smooth fit:

For ease in installation, the product should be installed at temperatures above 72° F. Below this temperature, the fabric may contract an inch or more, making it difficult to fit to the vehicle. It is normal for fabric to contract and wrinkle when stored in the shipping carton. Within a few days after the installation, the fabric will relax and the wrinkles will disappear.

 **WARNING** This product is designed primarily to enhance the appearance of the vehicle and to shield the occupants from ordinary weather conditions. Do not rely in any way on the components of this product to contain occupants within the vehicle, or to protect against injury or death in the event of an accident. This product will not protect the occupants from falling objects. Never operate the vehicle in excess of manufacturer's specifications.

WEAR SEAT BELTS AT ALL TIMES

Read and follow, precisely, all installation instructions provided when installing product. Failure to do so may result in a poor fit and could place occupants of the vehicle in a potentially dangerous situation.

Headliner – Installation Instructions

Parts List

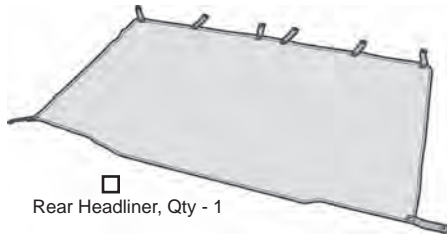

□ Rear Headliner, Qty - 1

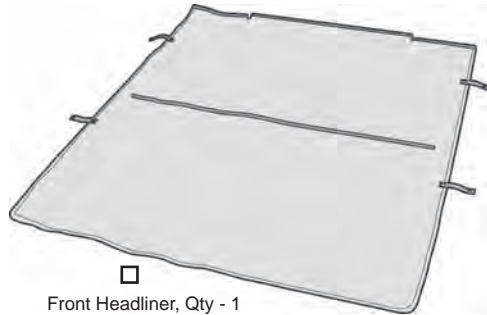

□ Front Headliner, Qty - 1

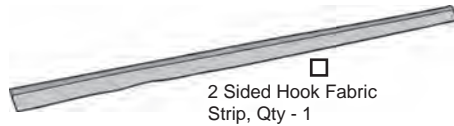

□ 2 Sided Hook Fabric Strip, Qty - 1



□ 80" Self-Adhesive Hook Strip, Qty - 1

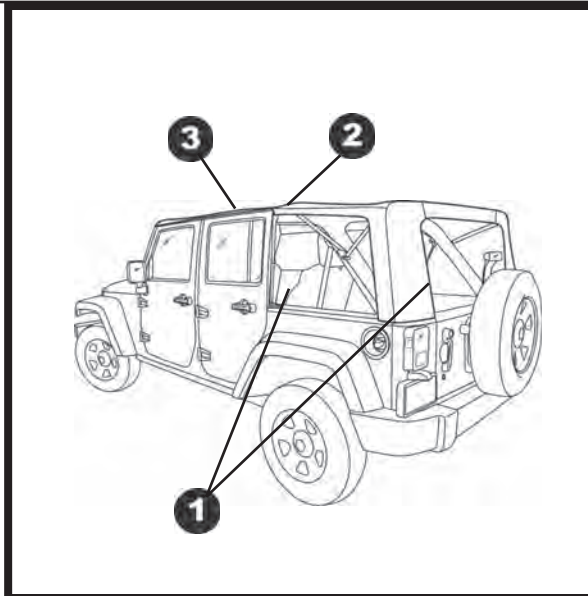

1 Remove Rear and Side Windows

Remove the Rear and Side Windows on the Top.



2 Remove Top from Center Bow

Remove the four (4) screws that fasten the Top to the Center Bow. Set them aside to be reinstalled later.

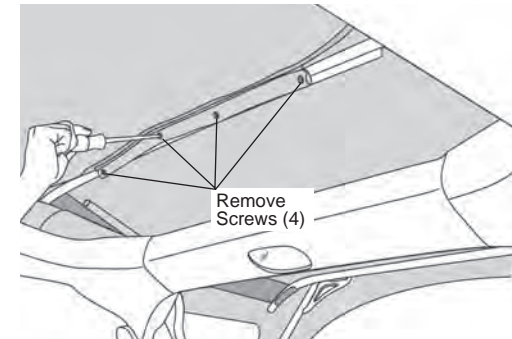

Remove Screws (4)

3 Release Top from Front Bow 2007 – 2009 Vehicles Only

Release the hook and loop flap around the Front Bow.

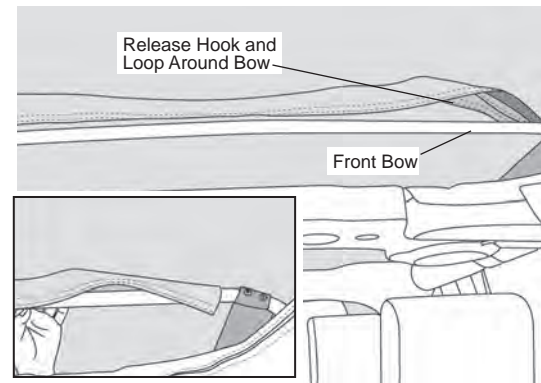

Release Hook and Loop Around Bow

Front Bow

Headliner – Installation Instructions

4 Remove Top from Header

Remove the two (2) screws that secure the Top to the Header on each side. Set them aside to be reinstalled later.

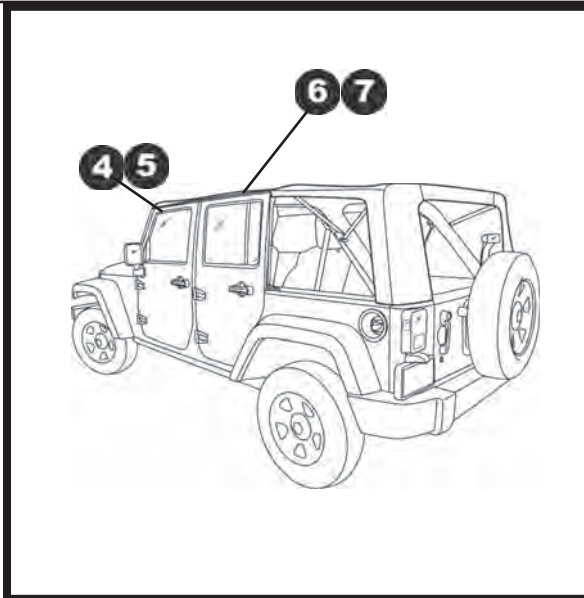
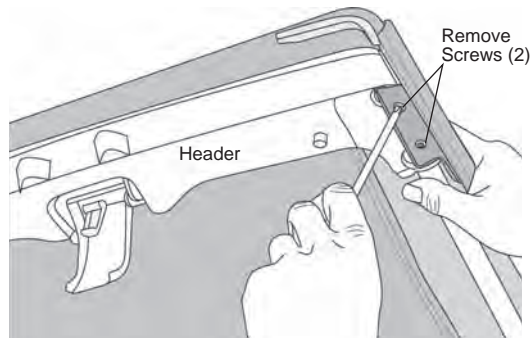

6 Install 2 Sided Hook Strip 2007 – 2009 Vehicles Only

Fasten the 2 Sided Hook Strip to the loop on the flap around the Center Bow. Close the flap and the 2 Sided Hook Strip around the bow.

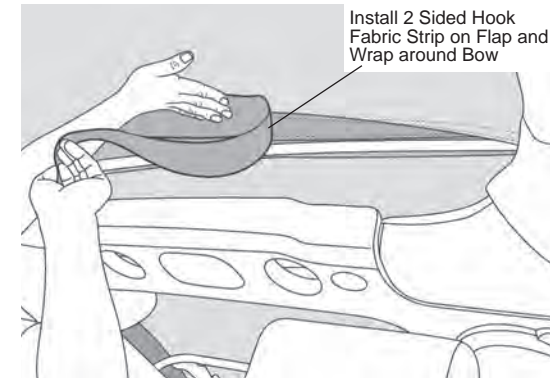

5 Install Adhesive Hook on Header

Cut a length of Adhesive Hook Strip to match the loop strip sewn to the front of the Headliner. Peel the backing off the Adhesive Hook Strip a little at a time and press it firmly into place on the Header as shown. Repeat on both sides of the vehicle.

NOTE Allow 72 hours for the adhesive to set. Avoid unnecessary fastening and unfastening of the Headliner during this period.

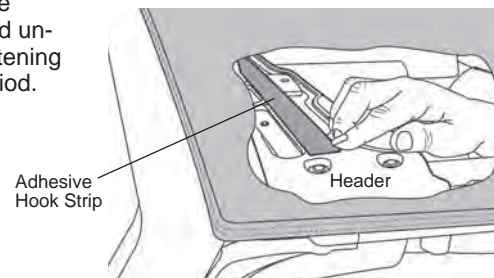

7 Install 2 Sided Hook Strip 2010 and Newer Vehicles Only

To secure the 2 Sided Hook Strip to the Center Bow on 2010 and newer vehicles, remove one flap screw at a time. Align the top (loop) side of the Hook Strip to the top of the fabric flap. Punch a small hole in the Hook Strip and reinstall the screw. Repeat for all four (4) screws. Make sure that the hook side of the 2 Sided Hook Strip faces outward.

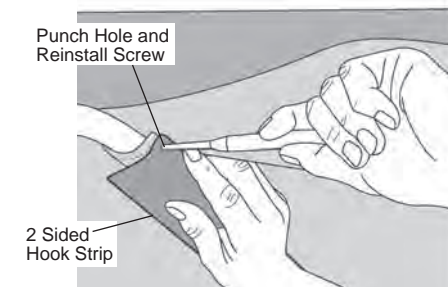
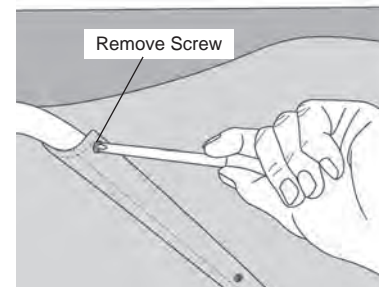

Headliner – Installation Instructions

8 Secure Front Headliner to Header

Center the Front Headliner on the vehicle. Fasten the loop strip sewn to the front of the Front Headliner to the Adhesive Hook Strip installed on the Header.

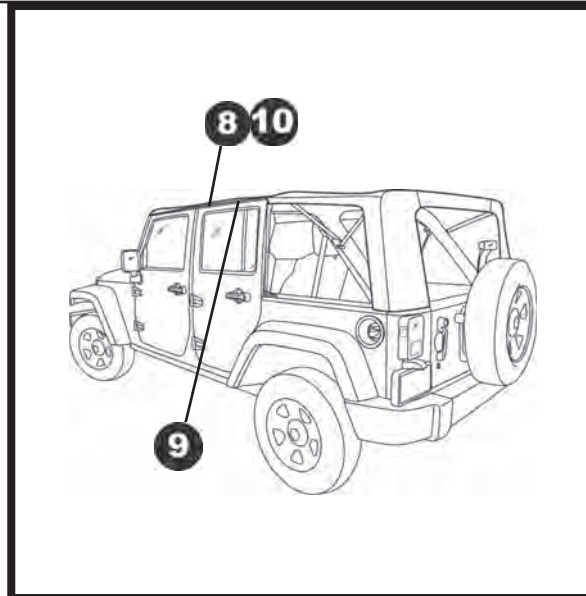
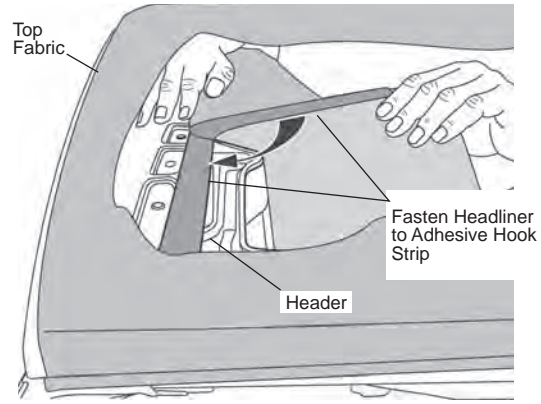

10 Secure Front Headliner Strap

Wrap the front strap on the Front Headliner around the Side Bow and snap it to itself. Repeat on both sides.

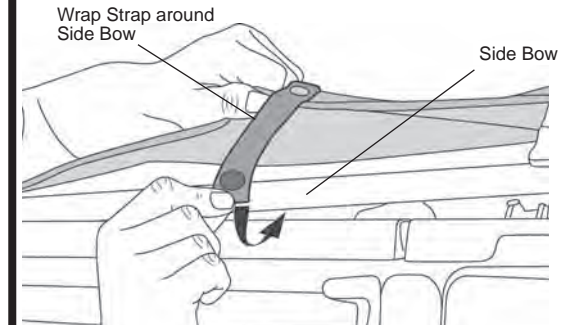

9 Slip Front Headliner over Sound Bar

Slip the Front Headliner Fabric between the Sound Bar and the Top Fabric.

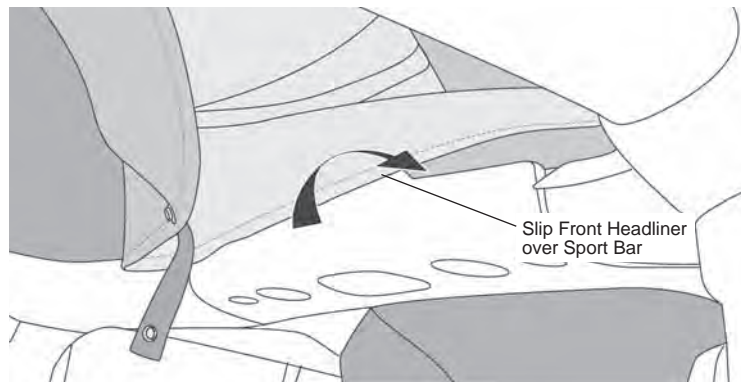

Headliner – Installation Instructions

11 Secure Rear Headliner Strap

Slip the Headliner between the Sport Bar and the Top Fabric.

Wrap the rear strap on the Front Headliner around the Side Bow and snap it to itself. Repeat on both sides.

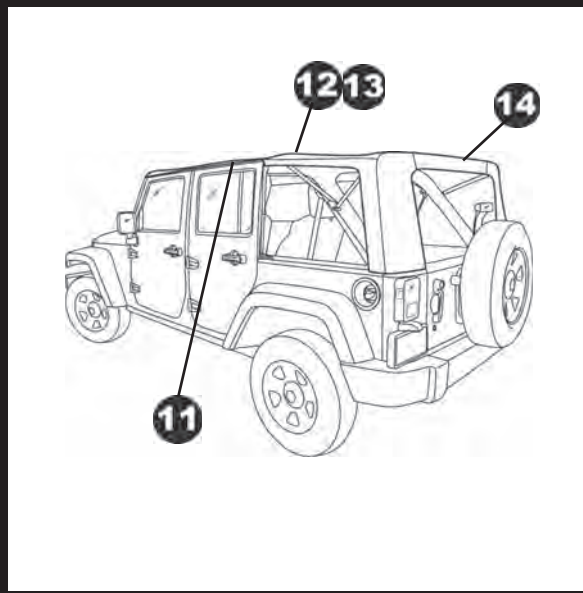
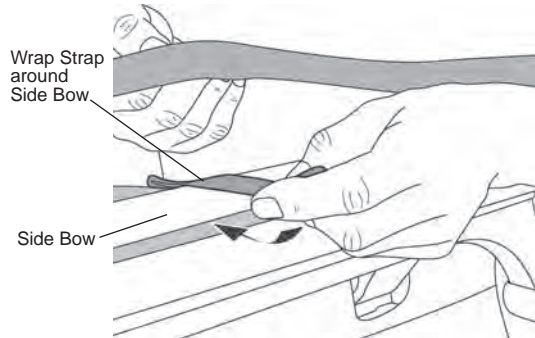

14 Secure Rear Straps

Wrap the six (6) rear straps of the Rear Headliner around the Rear Bow and snap them to themselves.

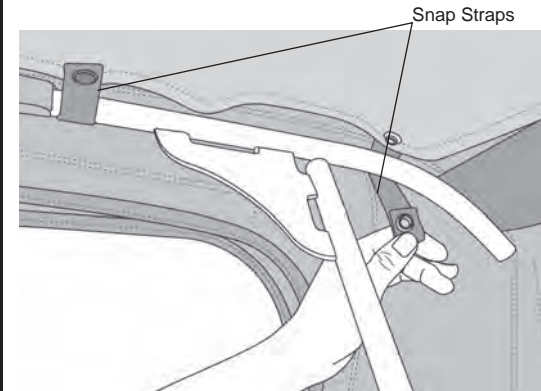

12 Install Adhesive Hook on Center Bow

Cut a length of Adhesive Hook Strip to match the loop strip sewn to the Headliner. Use the loop strip in the Headliner as a guide to install Adhesive Hook Strips on the Center Bow. Peel the backing off the Adhesive Hook Strip and press it firmly into place.

NOTE Allow 72 hours for the adhesive to set. Avoid unnecessary fastening and unfastening of the Headliner during this period.

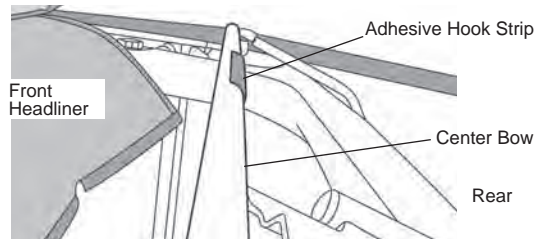

13 Secure Rear Headliner to Center Bow

Place the Rear Headliner over the Center Bow and align the holes. Use the screws removed in Step 3 to secure the Top flap and the Rear Headliner to the Rear Bow.

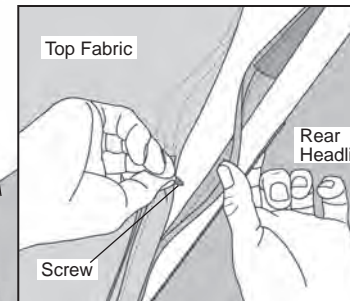
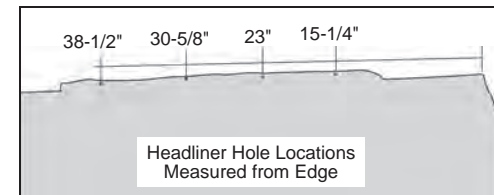
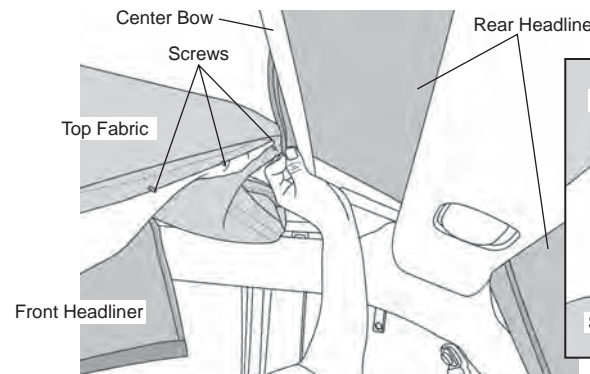

Headliner – Installation Instructions

15 Secure Front Headliner to Rear Headliner

Pull the Front Headliner back and fasten it to the Adhesive Hook Strip installed on the Center Bow. Then fasten it to the Rear Headliner.

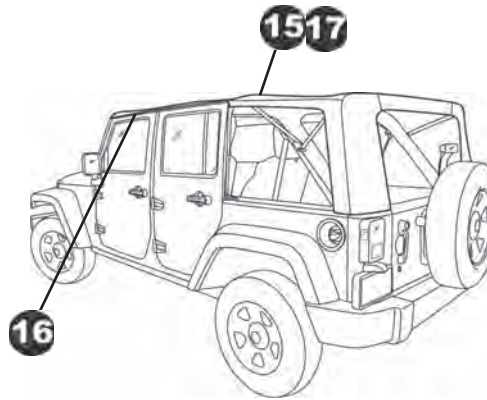
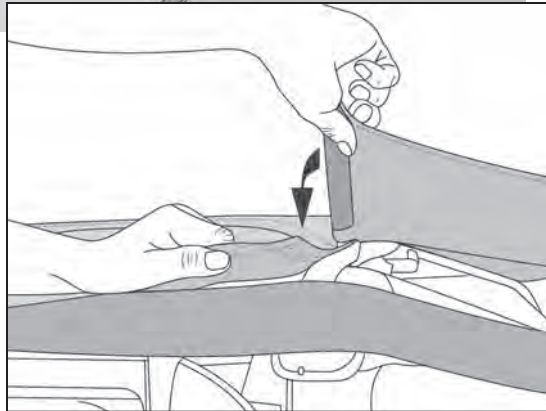
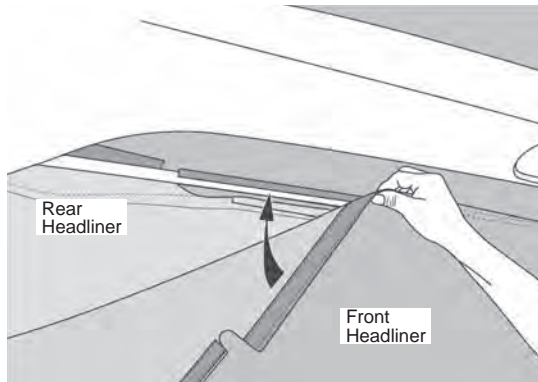

17 Secure Front Headliner to Center Bow

Press up on the Front Headliner to secure it to the Adhesive Hook Strip installed on the Center Bow in Step 6 and 7.



16 Reinstall Top to Header

Reinstall the two (2) screws removed in Step 5 to secure the Top to the Header on each side.

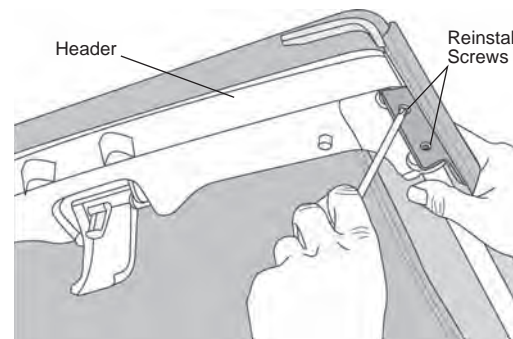

Headliner – Installation Instructions

Care and Maintenance of your Bestop Product

Your Bestop product is made of the finest materials available. To keep it looking new and for the maximum possible wear, it will need periodic cleaning and maintenance.

Washing: The fabric should be washed often using soap, warm water and a soft bristle brush. Rinse with clear water to remove all traces of soap or use Bestop-recommended Bestop Cleaner and Bestop Protectant. Bestop Cleaner and Bestop Protectant are specially formulated to provide a total cleaning and protection system. Bestop Cleaner will not harm vehicle finish, is biodegradable and environmentally friendly. Bestop Protectant protects against UV-fading, cracking and hardening.

Windows: Keep windows clean to avoid scratching. DO NOT use a brush on the windows! Wash with a water-soaked cloth or sponge and a mild dishwashing detergent or use Bestop-recommended Bestop Vinyl Window Cleaner, which safely cleans and protects vinyl windows while helping prevent UV damage. NEVER WIPE THE WINDOWS WHEN THEY ARE DRY. Be careful when cleaning snow or frost from the vinyl windows since they are easily scratched and may crack at low temperatures. DO NOT roll the sides or rear window in cold weather. The windows become stiff and will crack.

Zippers: Keeping the zipper cleaned and lubricated with a silicone lubricant will help prevent damage and keep the zippers in a smooth working condition. If a zipper opens behind the slider, the slider may have been spread apart. This problem can usually be repaired by using an ordinary pair of pliers to bring the sides back into parallel. Return slider to the end of the zipper in the normal Open position. Squeeze lightly at first and test the zipper. If the zipper continues to remain open squeeze more firmly with the pliers and try the zipper again. Repeat this procedure until the zipper operates correctly.

Water: Seeping through at the seams may be stopped by applying 3-M Scotchgard® on the inside of the seams. Rips in the fabric may be repaired with Bondex® iron on patches. Iron the patches to the Inside of the top, carefully following the Bondex® instructions.

Snaps: Keep snaps cleaned and lubricated with silicone to help prevent snaps from sticking to the studs. If a snap does become stuck to a stud, use a screwdriver and GENTLY pry apart to prevent permanent damage to the snap or the top fabric.

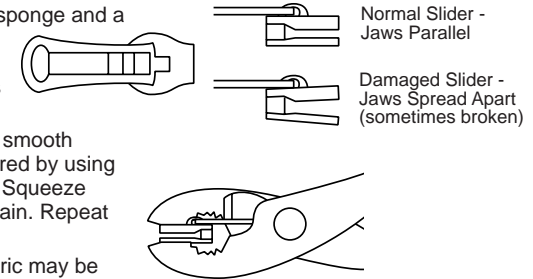

LIMITED WARRANTY

We warrant our product to be free from defects in material and workmanship, for the terms specified below, provided there has been normal use and proper maintenance. This warranty applies to the original purchaser only. All remedies under this warranty are limited to the repair or replacement of any item or items found by the factory to be defective within the time period specified. If you have a warranty claim, first you must call our factory at the number below for instructions. You must retain proof of purchase and submit a copy with any items returned for warranty work. Upon completion of warranty work, if any, we will return the repaired or replaced item or items to you freight prepaid. Damage to our products caused by accidents, fire, vandalism, negligence, misinstallation, misuse, Acts of God, or by defective parts not manufactured by us, is not covered under this warranty.

THE WARRANTY TIME PERIOD IS AS FOLLOWS FOR REPLACE-A-TOP™, SAILCLOTH REPLACE-A-TOP™, SUPERTOP®, SUPERTOP® REPLACEMENT SKINS, SUNRIDER®, AND TIGERTOP®: TWO YEARS FROM DATE OF PURCHASE.

THE WARRANTY TIME PERIOD IS AS FOLLOWS FOR ALL OTHER "SOFT GOODS" MANUFACTURED BY OUR COMPANY (USING PRIMARILY VINYL, PLASTICS, AND/OR FOAM): ONE YEAR FROM DATE OF PURCHASE.

THE WARRANTY TIME PERIOD IS AS FOLLOWS FOR ALL OTHER "HARD GOODS" MANUFACTURED BY OUR COMPANY (USING PRIMARILY METALS, PLASTICS, AND/OR FIBERGLASS): ONE YEAR FROM DATE OF PURCHASE.

ANY IMPLIED WARRANTIES OF MERCHANTABILITY AND/OR FITNESS FOR A PARTICULAR PURPOSE CREATED HEREBY ARE LIMITED IN DURATION TO THE SAME DURATION AND SCOPE AS THE EXPRESS WRITTEN WARRANTY. OUR COMPANY SHALL NOT BE LIABLE FOR ANY INCIDENTAL OR CONSEQUENTIAL DAMAGE.

Some states do not allow limitations on how long an implied warranty lasts, or the exclusion or limitation of incidental or consequential damages, so the above limitations or exclusions may not apply to you. This warranty gives you specific legal rights, and you may also have other rights which vary from state to state.



For further information or request for warranty work, please contact:

Bestop Inc., Customer Service
Toll-Free: (800) 845-3567
Main: (303) 465-1755
E-mail: csbestop@Bestop.com
Website: www.Bestop.com