





Installation Instructions Soundbar Cap

Vehicle Application

- Jeep Wrangler JK and JK Unlimited
(2 Door and 4 Door Models)
2007 to current
Part Number: 80040

www.Bestop.com - We're here to help! Visit our web site and click on "[Ask a Question](#)". Click here for more [Jeep Accessories by Bestop](#).

INSTALLATION TIME	SKILL LEVEL
 1/4 Hour	 1 - Easy

TOOLS
 Safety Glasses





Installation Tips

Before you begin installing this assembly, read all instructions thoroughly.

For a smooth fit:

For ease in installation, the product should be installed at temperatures above 72° F. Below this temperature, the fabric may contract an inch or more, making it difficult to fit to the vehicle. It is normal for fabric to contract and wrinkle when stored in the shipping carton. Within a few days after the installation, the fabric will relax and the wrinkles will disappear.

 **CAUTION** Safety glasses should be worn at all times while installing this product.

 **WARNING** This product is designed primarily to enhance the appearance of the vehicle and to shield the occupants from ordinary weather conditions. Do not rely in any way on the components of this product to contain occupants within the vehicle, or to protect against injury or death in the event of an accident. This product will not protect the occupants from falling objects. Never operate the vehicle in excess of manufacturer's specifications.

WEAR SEAT BELTS AT ALL TIMES

Read and follow, precisely, all installation instructions provided when installing product. Failure to do so may result in a poor fit and could place occupants of the vehicle in a potentially dangerous situation.

Soundbar Cap – Installation Instructions

Parts List

Speaker Cap Fabric Qty - 1

1 Lower Soft Top

If your vehicle has a soft top, release the top from the windshield and lay the top and bows down on the tailgate.

2 Install Speaker Cap

Orient the Speaker Cap with the main opening on the long edge towards the front and with the speaker holes towards the bottom of the vehicle.

Wrap the front flap of the Speaker Cap around the speaker bar and the front of the sport bar and fasten the hook and loop strips to each other.

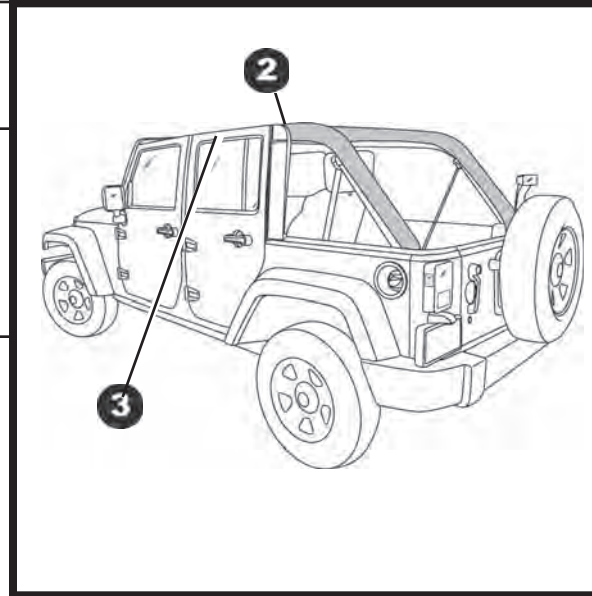
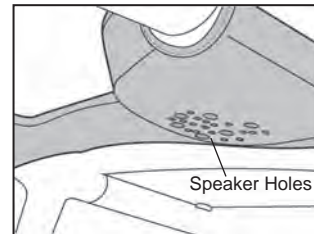
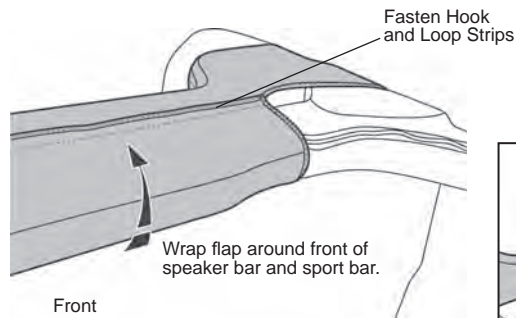

3 Secure the Sides

Fasten the hook and loop strips on the sides of the Speaker Cap.

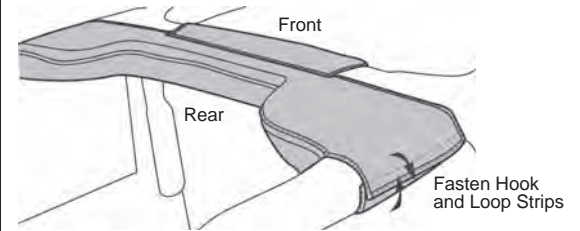

Soundbar Cap – Installation Instructions

Care and Maintenance of your Bestop Product

Your Bestop product is made of the finest materials available. To keep it looking new and for the maximum possible wear, it will need periodic cleaning and maintenance.

Washing: The fabric should be washed often using soap, warm water and a soft bristle brush. Rinse with clear water to remove all traces of soap or use Bestop-recommended Bestop Cleaner and Bestop Protectant. Bestop Cleaner and Bestop Protectant are specially formulated to provide a total cleaning and protection system. Bestop Cleaner will not harm vehicle finish, is biodegradable and environmentally friendly. Bestop Protectant protects against UV-fading, cracking and hardening.

LIMITED WARRANTY

We warrant our product to be free from defects in material and workmanship, for the terms specified below, provided there has been normal use and proper maintenance. This warranty applies to the original purchaser only. All remedies under this warranty are limited to the repair or replacement of any item or items found by the factory to be defective within the time period specified. If you have a warranty claim, first you must call our factory at the number below for instructions. You must retain proof of purchase and submit a copy with any items returned for warranty work. Upon completion of warranty work, if any, we will return the repaired or replaced item or items to you freight prepaid. Damage to our products caused by accidents, fire, vandalism, negligence, misinstallation, misuse, Acts of God, or by defective parts not manufactured by us, is not covered under this warranty.

THE WARRANTY TIME PERIOD IS AS FOLLOWS FOR REPLACE-A-TOP™, SAILCLOTH REPLACE-A-TOP™, SUPERTOP®, SUPERTOP® REPLACEMENT SKINS, SUNRIDER®, AND TIGERTOP®: TWO YEARS FROM DATE OF PURCHASE.

THE WARRANTY TIME PERIOD IS AS FOLLOWS FOR ALL OTHER “SOFT GOODS” MANUFACTURED BY OUR COMPANY (USING PRIMARILY VINYL, PLASTICS, AND/OR FOAM): ONE YEAR FROM DATE OF PURCHASE.

THE WARRANTY TIME PERIOD IS AS FOLLOWS FOR ALL OTHER “HARD GOODS” MANUFACTURED BY OUR COMPANY (USING PRIMARILY METALS, PLASTICS, AND/OR FIBERGLASS): ONE YEAR FROM DATE OF PURCHASE.

ANY IMPLIED WARRANTIES OF MERCHANTABILITY AND/OR FITNESS FOR A PARTICULAR PURPOSE CREATED HEREBY ARE LIMITED IN DURATION TO THE SAME DURATION AND SCOPE AS THE EXPRESS WRITTEN WARRANTY. OUR COMPANY SHALL NOT BE LIABLE FOR ANY INCIDENTAL OR CONSEQUENTIAL DAMAGE.

Some states do not allow limitations on how long an implied warranty lasts, or the exclusion or limitation of incidental or consequential damages, so the above limitations or exclusions may not apply to you. This warranty gives you specific legal rights, and you may also have other rights which vary from state to state.



For further information or request for warranty work, please contact:

Bestop Inc., Customer Service

Toll-Free: (800)845-3567

Main: (303)465-1755

E-mail: csbestop@Bestop.com

Website: www.Bestop.com