



Bestop

Windjammer Installation Instructions

For: 1995 GEO Tracker and
Suzuki Sidekick

Part Number 80062

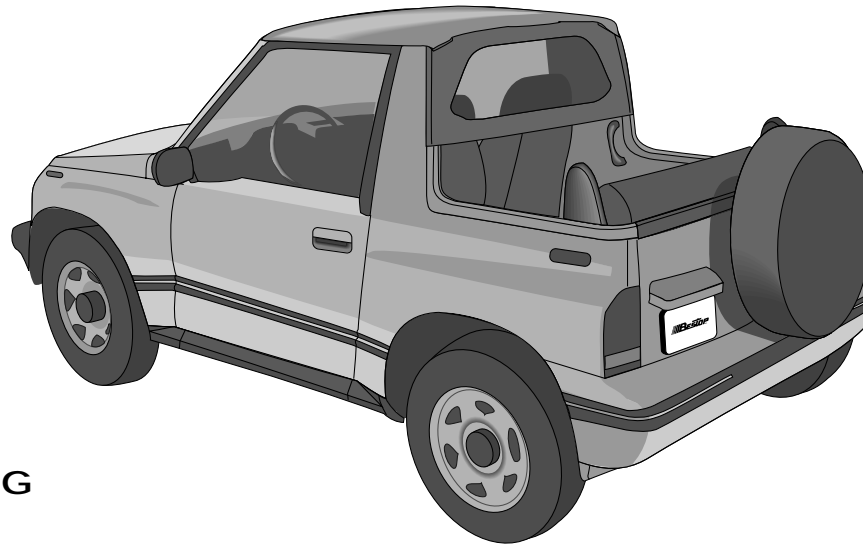

WARNING

This product is designed to enhance the appearance of the vehicle and to shield the occupants from ordinary weather conditions. Do not rely in any way on the components of this product to contain occupants within the vehicle, or to protect against injury or death in the event of an accident. This product will not protect the occupants from falling objects. Never operate vehicle in excess of manufacturer's specifications.

WEAR SEAT BELTS AT ALL TIMES.

Read and follow, precisely, all installation instructions provided when installing this product. Failure to do so may result in a poor fit and could place occupants of the vehicle in a potentially dangerous situation.

Installation Tips

Before you begin installing this Windjammer assembly, read all instructions thoroughly. Below are a few tips to make this installation easier.

For a smooth fit:

For ease in installation, the Windjammer should be installed at temperatures above 72° F. Below this temperature, the fabric may contract an inch or more, making it difficult to fit to the vehicle.

It is normal for the fabric to contract and wrinkle when stored in the shipping carton. Within a few days after the installation, the fabric will relax and the wrinkles will disappear.

Step One

Fold the seats forward in order to stand in the back of the vehicle.

Orient the Windjammer with the snap flap toward the front.

Drape the Windjammer over the header with the snaps toward the front. Snap the flaps to the header panel on each side of the dome light.

Note: If this product is being used with a Bikini, unfasten the back of the Bikini in order to proceed with the Windjammer installation.

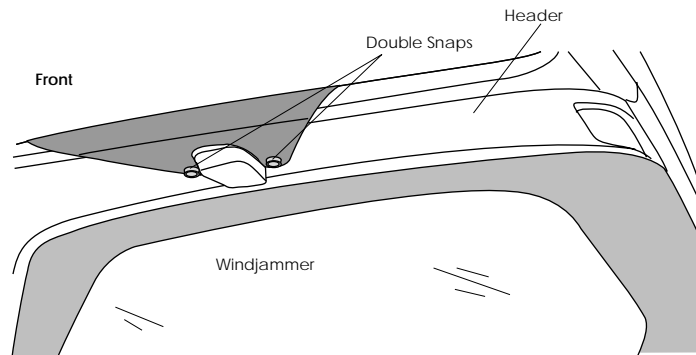

View from inside vehicle - looking toward rear

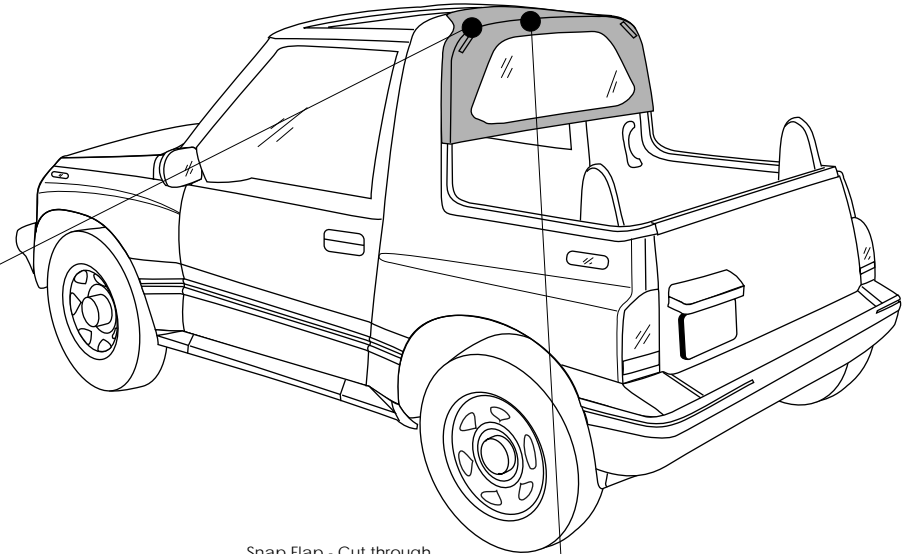

Corner Straps - Cut through center part of plastic reinforcement, feed straps through and attach to handle

Snap Flap - Cut through center part of plastic reinforcement, thread through opening and snap to double snaps

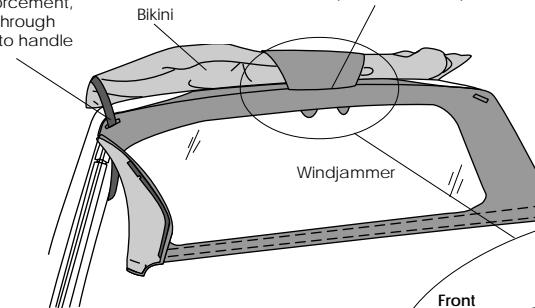

Step Two - Optional

If a you are using a Bikini with the Windjammer, locate the three reinforced plastic areas along the top, rear of the Windjammer (a small arear near each corner and a large area in the center). Cut through the center part of each reinforcement. Thread the snap flaps on the Bikini through the large, center opening. Snap the flaps to the double snaps on the Windjammer, on each side of the dome light. Then feed the rear straps through openings at the corners of the Windjammer and attach them to the handles inside the vehicle.

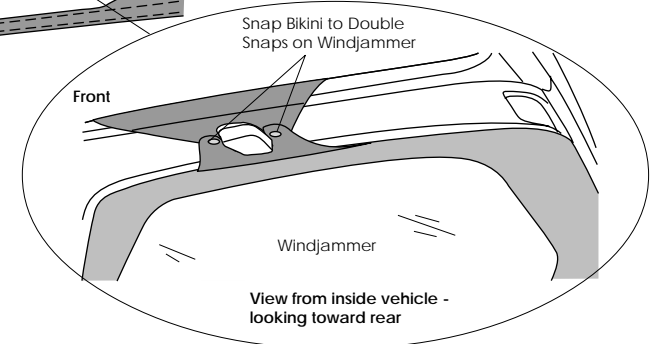

View from inside vehicle - looking toward rear



80062 2

Step Three

The plastic strip sewn along the sides of the Windjammer is notched to fit around the stop in the retainer. Working the notch around the stop, slip the plastic into the retainer on the vehicle.

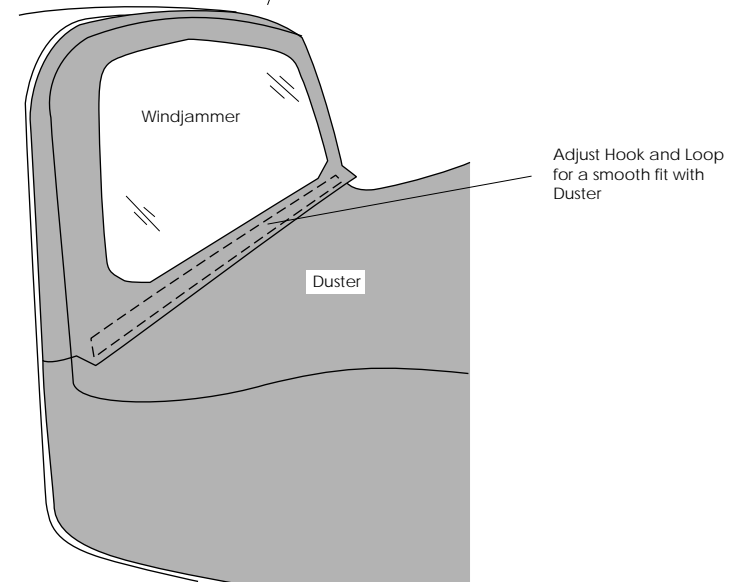
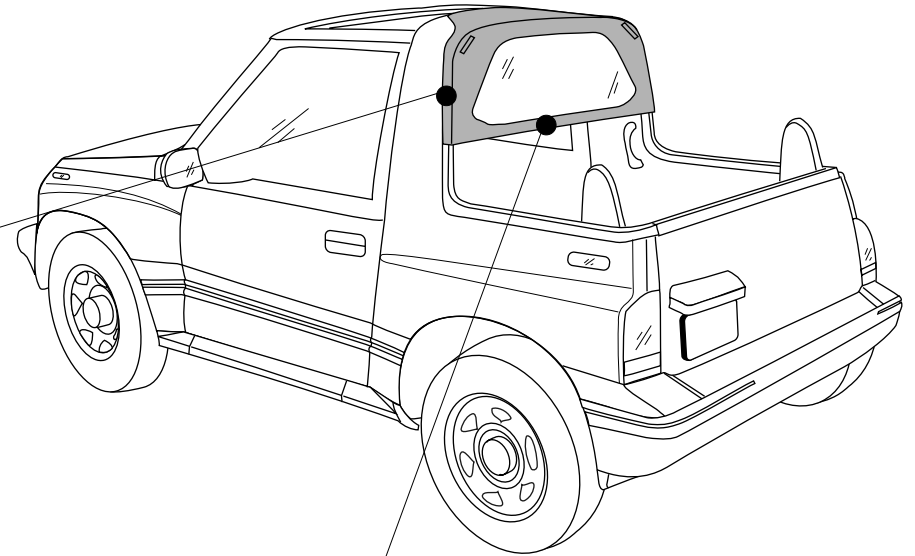
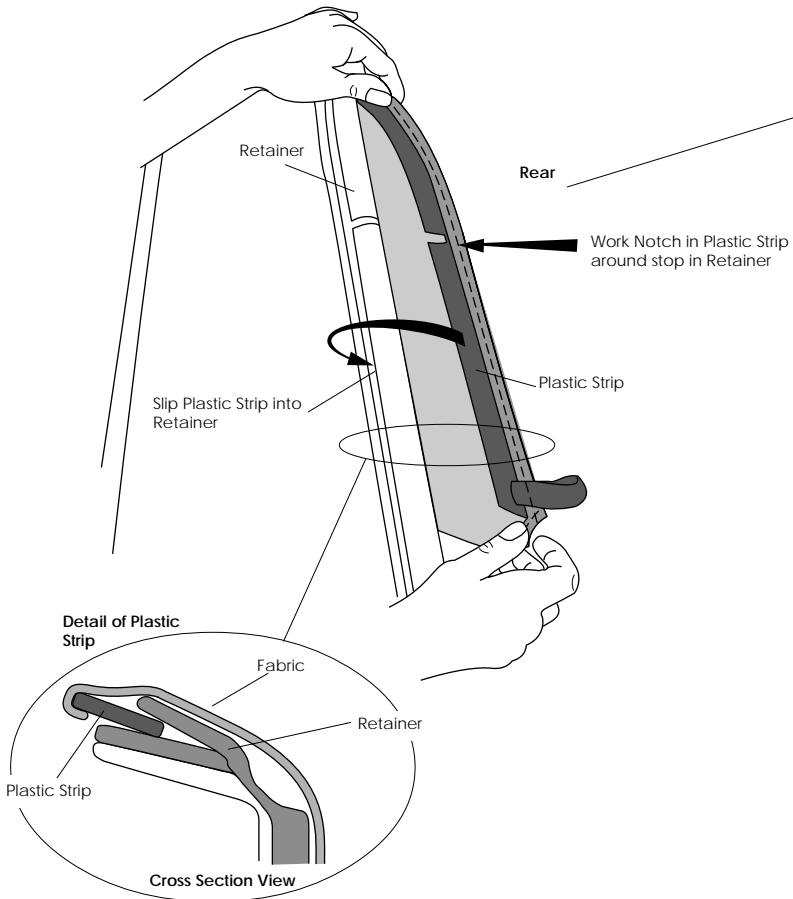

Step Four - Optional

If you are using a Duster with the Windjammer, adjust the hook and loop along the bottom of the Windjammer and the top of the Duster for a smooth fit.



80062 3

The Bestop and Roughrider brand Windjammer Rear Window Assemblies are designed for use as "stand alone" accessories or may be used in conjunction with Duster Deck Covers and Bikini Tops. If you wish to order additional accessories for your Tracker/Sidekick, please advise your supplier using the part numbers illustrated below:

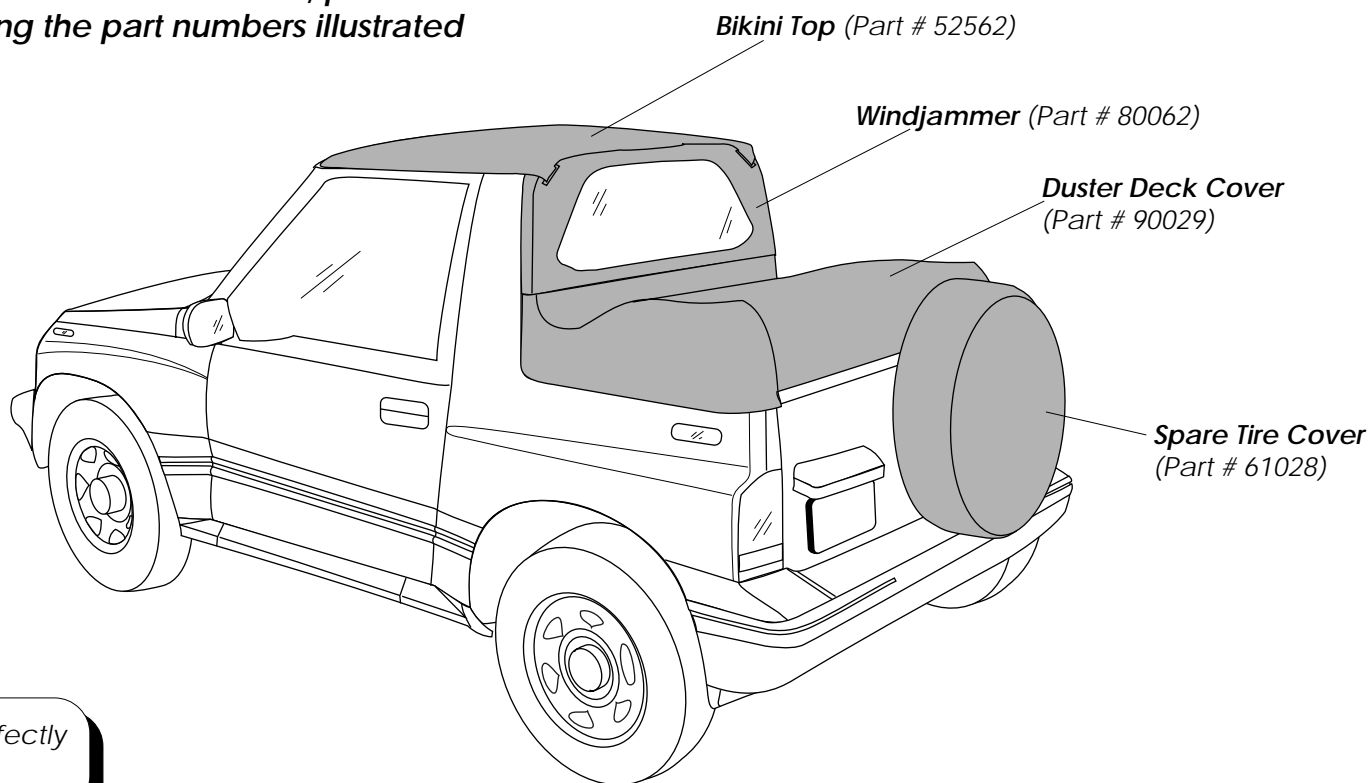

All accessories are perfectly color matched.

Similar accessories are available for 1994 or earlier model vehicles. Please ask your supplier.



80062 4

Care and Maintenance of your Bestop Top

Your top is made of the finest materials available. To keep it looking new and for the maximum possible wear, it will need periodic cleaning and maintenance.

Washing: The top fabric should be washed often using soap, warm water and a soft bristle brush. Rinse with clear water to remove all traces of soap.

Windows: Keep windows clean to avoid scratching. DO NOT use a brush on the windows! Wash with a watersoaked cloth or sponge and a mild dishwashing detergent. NEVER WIPE THE WINDOWS WHEN THEY ARE DRY. Be careful when cleaning snow or frost from the vinyl windows since they are easily scratched and may crack at low temperatures. DO NOT roll the sides or rear window in cold weather. The windows become stiff and will crack.

Water: Seeping through at the seams may be stopped by applying 3-M Scotchgard® on the inside of the seams. Rips in the fabric may be repaired with Bondex® iron on patches. Iron the patches to the inside of the top, carefully following the Bondex® instructions.

Snaps: Keep snaps cleaned and lubricated with silicone to help prevent snaps from sticking to the studs. If a snap does become stuck to a stud, use a screwdriver and GENTLY pry apart to prevent permanent damage to the snap or the top fabric.

LIMITED WARRANTY

We warrant our product to be free from defects in material and workmanship, for the terms specified below, provided there has been normal use and proper maintenance. This warranty applies to the original purchaser only. All remedies under this warranty are limited to the repair or replacement of any item or items found by the factory to be defective within the time period specified.

If you have a warranty claim, first you must call our factory at the number below for instructions. You must retain proof of purchase and submit a copy with any items returned for warranty work. Upon completion of warranty work, if any, we will return the repaired or replaced item or items to you freight prepaid. Damage to our products caused by accidents, fire, vandalism, negligence, misinstallation, misuse, Acts of God, or by defective parts not manufactured by us, is not covered under this warranty.

THE WARRANTY TIME PERIOD IS AS FOLLOWS: ALL "SOFT GOODS" MANUFACTURED BY OUR COMPANY (USING PRIMARILY VINYL, PLASTICS, AND/OR FOAM): ONE YEAR FROM DATE OF PURCHASE.

ANY IMPLIED WARRANTIES OF MERCHANTABILITY AND/OR FITNESS FOR A PARTICULAR PURPOSE CREATED HEREBY ARE LIMITED IN DURATION TO THE SAME DURATION AND SCOPE AS THE EXPRESS WRITTEN WARRANTY. OUR COMPANY SHALL NOT BE LIABLE FOR ANY INCIDENTAL OR CONSEQUENTIAL DAMAGE.

Some states do not allow limitations on how long an implied warranty lasts, or the exclusion or limitation of incidental or consequential damages, so the above limitations or exclusions may not apply to you.

This warranty gives you specific legal rights, and you may also have other rights which vary from state to state.

For further information or request for warranty work, please contact:

Bestop Inc.
Customer Service
(800)346-3910
(303)465-1755



80062 5