

Installation Instructions

Chrysler TorqueFlite

Shift Improver Kit

Part No. 10225

1971-1977 A-727 (V-8)

1971-1977 A-904 (V-8)

(A-998 & A-999)

© 1998, 2005, 2010 by B&M Racing & Performance Products

This **B&M Chrysler TorqueFlite Shift Improver Kit** has been designed to work on all **1971 thru 1977 A-727 (V-8) 1971-1977 A-904 (V-8) (A-998 & A-999)** transmissions.

WARNING: Incorrect checkball placement can result in serious transmission damage. Be sure to follow the instructions carefully.

We recommend that you read through the instructions completely before beginning the installation, so you can familiarize yourself with the installation procedure and tools required. Check the tool list at the end of these instructions for the tools required to install your **B&M Chrysler TorqueFlite Shift Improver Kit**.

Installation of the **B&M Chrysler TorqueFlite Shift Improver Kit** can be accomplished by anyone with minimum mechanical experience. It is however, important to closely follow the instructions.

NOTE: The **B&M Chrysler TorqueFlite Shift Improver Kit** is not a cure-all for an ailing transmission. If your transmission is slipping or in poor general shape, the installation of this Shift Improver Kit may

worsen the condition. However on a properly operating transmission in average condition, the Shift Improver Kit will provide the kind of transmission performance you're looking for. When installing your Shift Improver Kit there are several other **B&M** products you may wish to consider:

Transmission Oil Cooler We feel that it is very important that every vehicle used in a heavy duty application (racing, towing, RV, etc.) should have an oil cooler. Heat is the major cause of transmission failures, and an oil cooler is an inexpensive safeguard against overheating and failure. **B&M** offers a wide range of transmission coolers to suit every need, which are available at your **B&M** dealer.

Trick Shift Performance ATF Trick Shift performance automatic transmission fluid is the industry's leading performance **ATF**. A specially blended oil with foam inhibitors, extreme pressure agents and shift improvers, this fluid assures protection while delivering the fastest possible shifts. You literally "Pour in performance."

TORQUEFLITE

INTRODUCTION

This kit can be installed in a few hours by carefully following directions. Read all instructions first to familiarize yourself with the parts and procedures. Work slowly and do not force any parts. Transmission components and valves are precision fit parts. Burrs and dirt are the number one enemies of an automatic transmission. Cleanliness is very important, so a clean work area or bench is necessary. We suggest a clean work bench top from which oil can easily be cleaned or a large piece of cardboard.

This kit contains all parts necessary to obtain two levels of performance depending on intended use:

Heavy Duty: Towing, campers, motor homes, police, taxi, on and off-road desert vehicles and 4-wheelers.

Street/Strip: Dual purpose performance vehicles. Street and strip high performance cars.

Automatic transmissions operate at temperatures between 150° F and 250° F. It is suggested that the vehicle be allowed to cool for a few hours to avoid burns from hot oil and parts. The vehicle should be off the ground for ease of installation. Jack stands, wheel ramps, or a hoist will work fine. **Make sure vehicle is firmly supported!** Try to raise it 1-2 feet so you have plenty of room to work easily. Also, have a small box or pan handy to put bolts in so they won't be lost, and a drain pan to catch oil.

STEP 1. Drain oil pan. Some model Torqueflites have drain plugs. If yours has a drain plug, remove it and allow the fluid to drain, then install drain plug back into pan. If you do not have a drain plug, you should consider installing a B&M pan Drain Plug Kit, #80250, at this time. To drain oil, remove each pan bolt one at a time, working toward the front of the transmission. Remove the last two bolts slowly and the pan will tilt down to allow the last of the fluid to

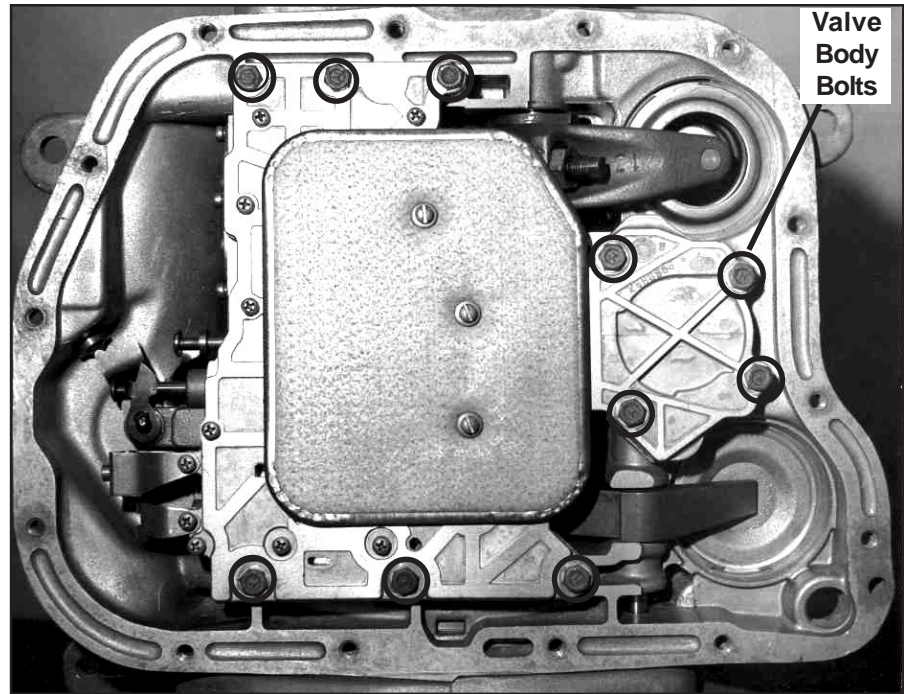

Figure 1

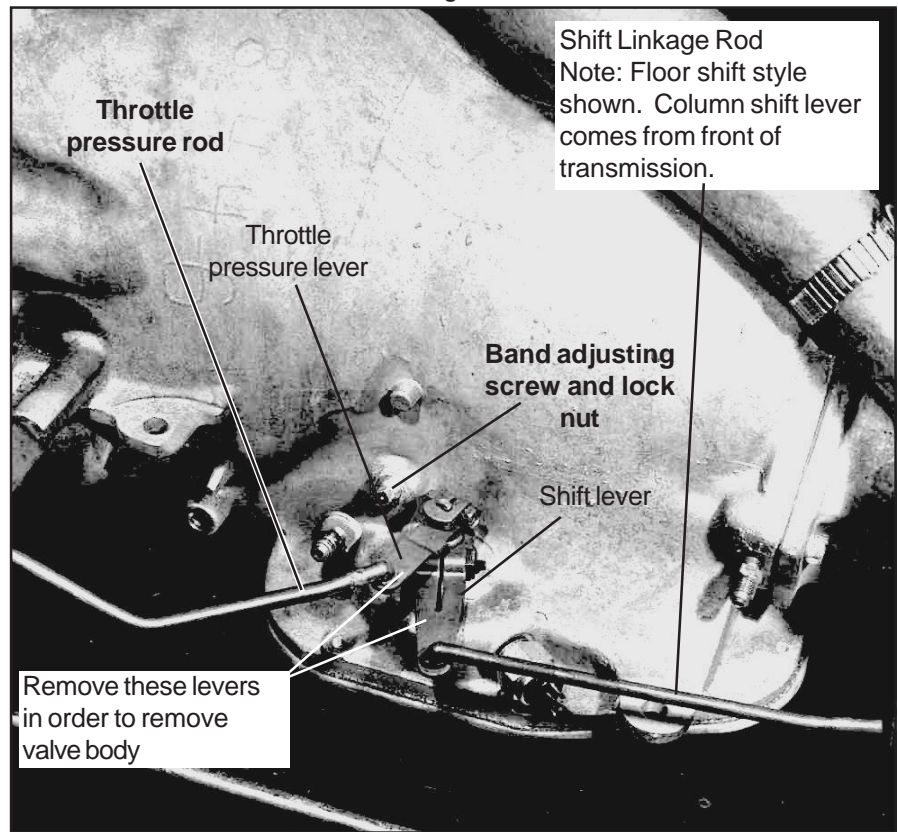

Figure 2

drain. If the pan sticks to the old gasket, pry it down slightly with a screwdriver before removing the last two bolts to break the seal. After the last bolt is removed the pan can be lowered and set aside.

STEP 2. The valve body will now be exposed. (See Fig. 1) It is held in place by ten ¼-20 bolts. Before the valve body can be removed you must disconnect shift and throttle linkage. (See Fig. 2) Throttle linkage is located on the left (driver) side of the case just above the valve body. The lever is attached to the throttle shaft

and held in place with a pinch bolt. Use a 7/16" wrench or socket and loosen the bolt but do not remove it. Use screwdriver to pry the lever up and off the shaft. Place transmission shift lever in low gear and shifter should also be in low gear. Loosen the pinch bolt and pry the selector lever off the larger manual lever shaft. Let the two levers hang free.

STEP 3. Remove the valve body by removing the ten bolts with a 7/16" wrench or socket. There is a spring between the valve body and the case so remove the last bolt slowly. This will also reduce the amount of oil splatter as the valve body is removed. Pull valve body down and forward to disengage park rod from back of case. It may be necessary to rotate driveshaft slightly to disengage the rod. There will be a spring (1-2 accumulator spring) between the valve body and case (See Fig. 3), remove and discard it. Place valve body in oil pan and set them on work bench.

STEP 4. Adjust front band. Loosen locknut. (See Fig. 2) Tighten band adjusting screw to 72-in. lbs. (snug). Then back off adjusting screw two full turns. Hold band adjusting screw and tighten 3/4" jam nut securely.

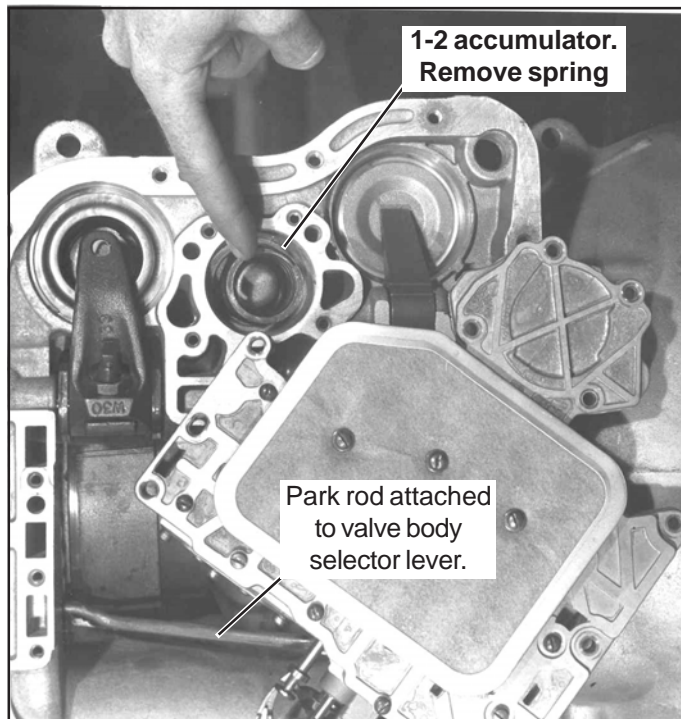

Figure 3

STEP 5. Your work bench should be clean as stressed in the beginning of these instructions. Place the valve body on the bench with the filter side up. Remove the three filter screws and remove the filter. Set the screws aside in a small tray so they won't be lost. As you disassemble the valve body, when removing a valve and a spring, keep them together.

Now remove the pressure regulator spring retainer located next to the selector lever. (See Fig. 4) Remove three shorts screws to remove retainer. Late model valve bodies with large cage will require removal of one long valve body screw. (See Fig. 5)

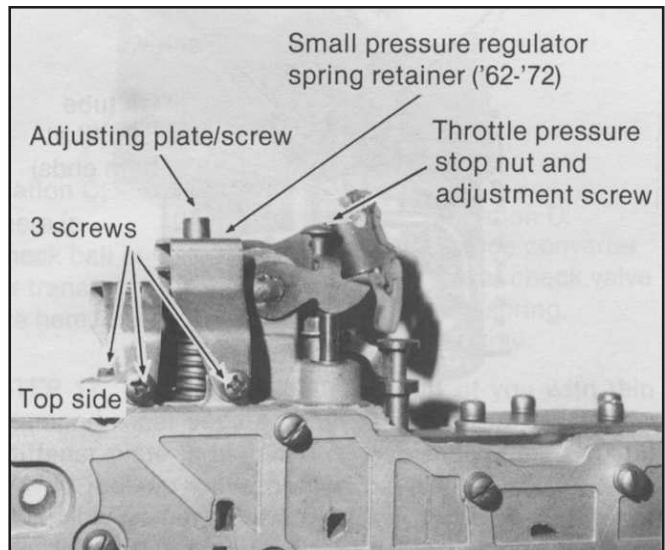

Figure 4

CAUTION: Hold your hand against the retainer while removing the screw (See Fig. 4) so the large pressure regulator spring does not fly out. Remove the retainer and adjustment plate, pressure regulator spring and converter valve spring and set them aside. Remove the regulator valve and converter valve and lay them next to their respective springs. Large cage models: Be careful that the throttle pressure valves do not fall out when working on the valve body.

STEP 6. Set the valve body on the bench with the filter side up and the selector lever assembly in the top left corner. The valve body consists of: (1) thick casting containing the valve bores and will be referred to as the casting; (2) a thin stamped steel plate with numerous different shaped holes called a separator plate, and; (3) a thin aluminum casting that looks like a maze called a transfer plate.

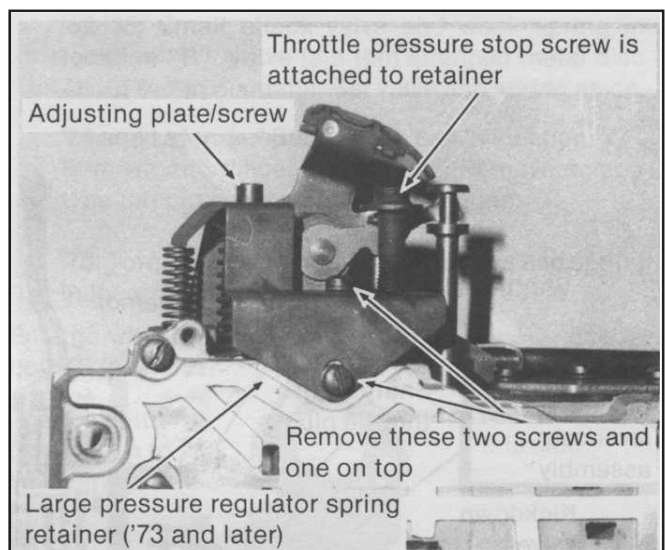

Figure 5

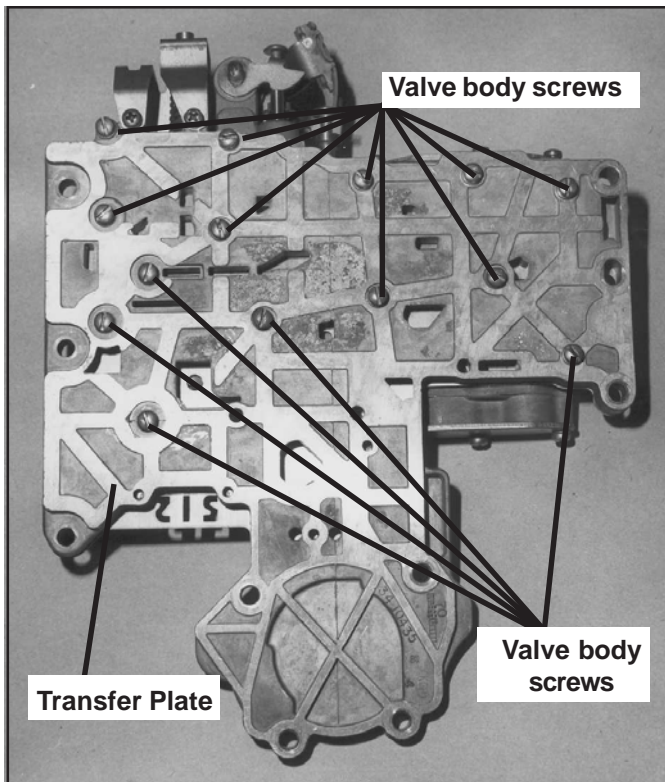

Figure 6

STEP 7. Valve Body Disassembly: (See Fig. 6) Remove the valve body screws from transfer plate. There will be fourteen of them, with either Phillips or slot heads. Hold the casting and transfer plate together with one hand while removing the last screw so you won't lose any internal parts. Carefully lift the transfer plate assembly off the casting to expose the oil passages. Turn the transfer plate assembly over so the separator plate is facing up and set it to your right. Inspect your casting for the following: (See Fig. 7)

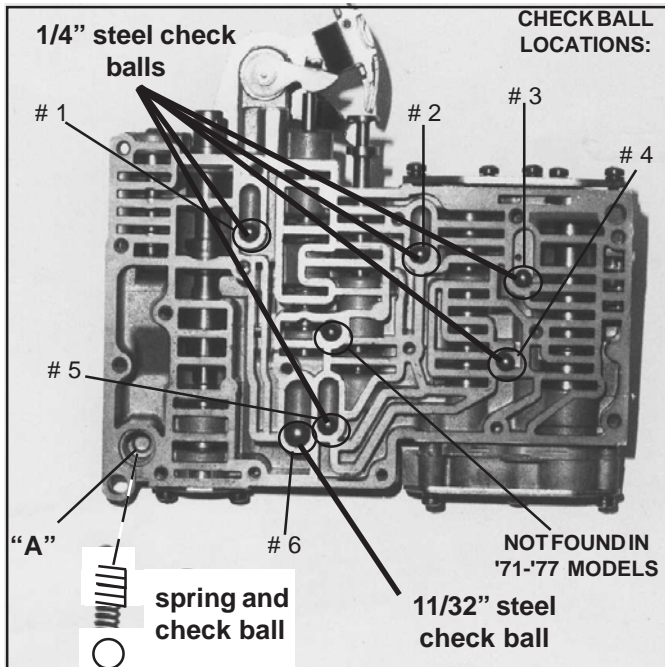

Figure 7

Large steel ball on a stiff spring underneath at location 7 on early models. Remove the ball and spring and discard.

Five 1/4" diameter steel check balls in locations 1 thru 5 and one 11/32" diameter steel check ball in location 6. (See Fig. 7) Remove these and place them in the tray.

STEP 8.

Heavy Duty: Go to Step 9

Street/Strip: Remove five short screws and remove the governor plug and plate. (See Fig 8) Do not rotate the selector lever as you will disengage the detent ball allowing it to fly out of position. Remove the shuttle valve throttle plug. Remove and discard the shuttle valve throttle plug spring.

Install the shuttle valve throttle plug rod supplied with the kit into the valve bore. Install the shuttle valve throttle plug into its bore. The plug must be flush or slightly below the surface of the casting to prevent leaks. Grind the rod down slightly if necessary to provide clearance. Install the governor plug end plate. You should be able to hold the plate flat against the casting with thumb pressure only. If you cannot hold the plate flat against the slight spring tension of the shift valves, the rod is too long. Install five short screws finger tight only.

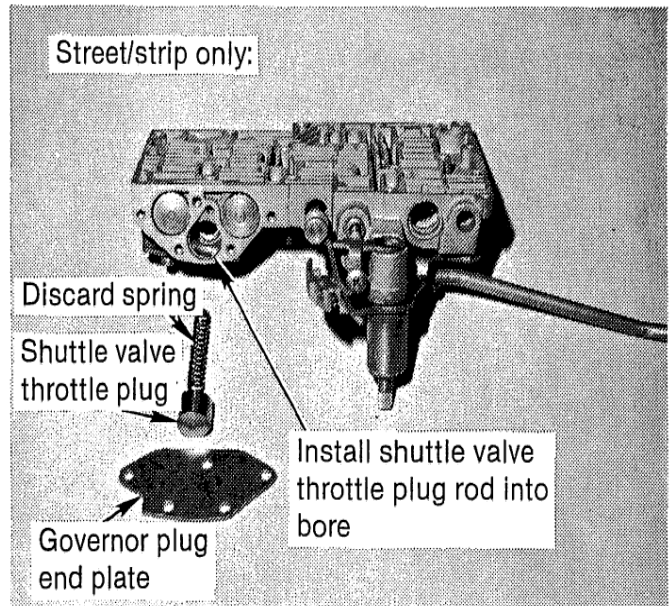

FIGURE 8

STEP 9. Remove three long screws and remove the limit valve end plate and small casting (See Fig. 9). Hold your hand on the end plate while removing the last screw so the three small springs underneath do not fly out and get lost. Install the 1/4" steel ball supplied with the kit into the 1-2 shift control valve bore inside the 1-2 shift control valve spring.

Install the limit valve end plate and casting. The assembly must sit flat against the valve body casting with thumb pressure only. Grind the valve slightly, if necessary, to provide clearance. Install three long screws finger tight only.

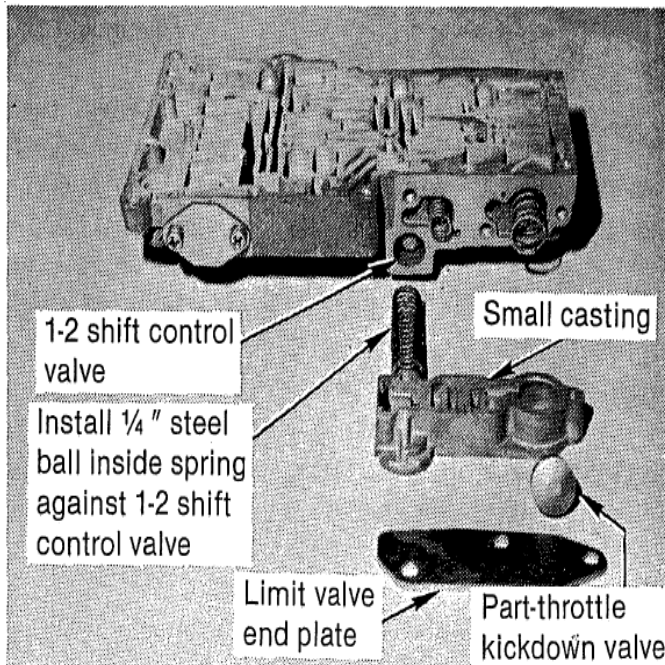

FIGURE 9

STEP 10. Install pressure regulator valve into its bore. (See Fig. 10) Install converter valve into its bore. Both valves should move freely and easily. Remove any burrs that may cause stickiness or binding. Set casting aside.

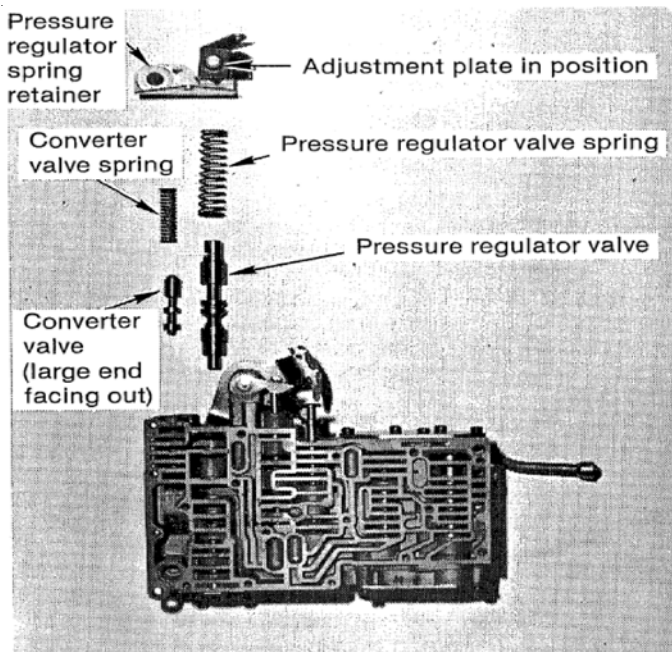

FIGURE 10

STEP 11. Place transfer plate and separator plate assembly in front of you. The thin metal separator plate will be held on with four or five short screws. Note how your

stiffener plate is positioned. (See Fig. 11) Remove the retaining screws and lift the separator plate off. If there is a check ball or screen type filter in your transfer plate, discard it.

Wash the transfer plate in solvent or brake cleaner to remove any dirt. Lay the transfer plate down on the bench with the passages facing up. Lay B&M separator plate in position on top of the transfer plate and align the screw holes. Install stiffener plate and retaining screws and tighten screws finger tight.

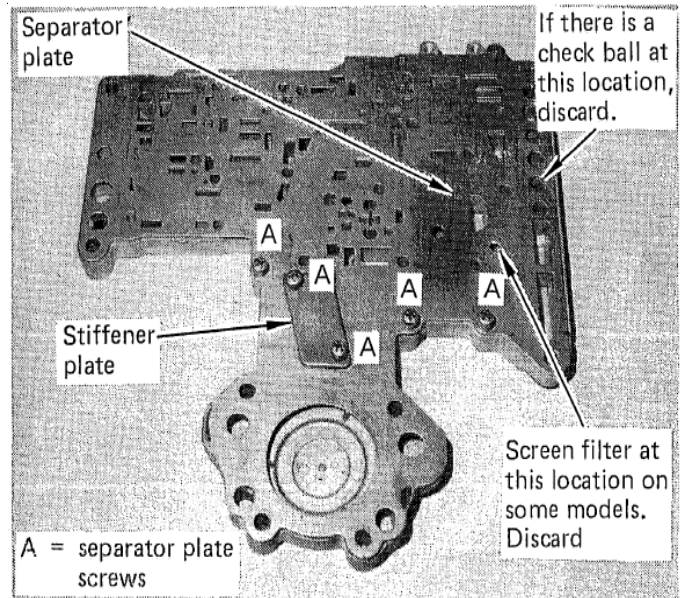

FIGURE 11

STEP 12. Lay casting in front of you and install steel Check balls as follows: (See Fig. 7)

All Models:

Install one 11/32" diameter check ball in location 6.

Heavy Duty: Five 1/4" steel balls in locations 1 thru 5

Street/Strip: Four 1/4" steel balls in locations 1,2,3, & 5.

Align transfer plate assembly over casting and hold the two halves together with your hand. Install fourteen screws in place finger tight. (Note: Three long screws are for the filter.) Install pressure regulator spring and converter valve spring in place. (See Fig. 10) Insert pressure regulator adjusting plate into place in retaining cage. Adjusting plate is a close fit when properly installed inside the retainer. Engage pressure regulator spring with adjusting plate and engage converter valve spring with prong in retainer. Hold retainer against valve body, align screw holes and install three short screws finger tight. (See Fig. 4)

STEP 13. Tighten fourteen screws attaching transfer plate to casting on the bottom of the valve body to 35in. lbs. Tighten all end plate screws to 35in. lbs. Adjust pressure regulator spring retainer from side to side until the distance from the manual valve to the adjusting screw is 1-7/8". Use the gauge supplied to check this measurement. (See Fig. 12) Tighten three short retaining screws to 35in. lbs. At this point all screws should be tight. NOTE: Adjustments are the same for large cage models.

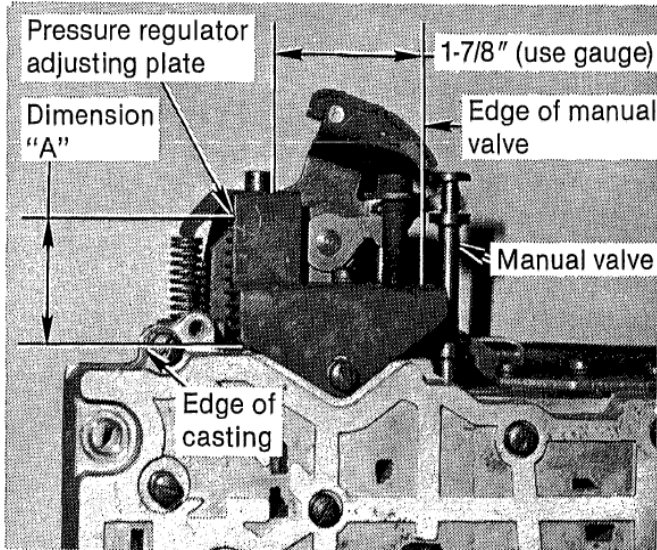

FIGURE 12

STEP 14. Pressure regulator adjustment: Use the gauge to adjust the distance from the casting face to the inside edge of the pressure regulator spring adjusting plate. (See Fig. 12) Use a 3/16" Allen wrench to adjust the plate to dimensions shown:

Heavy Duty: 1-1/4"

Dimension "A"

Street/Strip: 1-3/16"

Inspect your oil filter. If it has varnish on it, or the transmission has more than 20,000 miles, we recommend you replace your filter. Use B&M Filter #10288.

STEP 15. Guide the valve body up into the transmission. Insert the park rod into the hole in the rear of the case first and rotate the drive shaft until the rod engages the pawl. (See Fig. 13) Align valve body with case and install valve body against case. (Be careful not to damage neutral safety switch. A small screwdriver can be used to retract the switch out of the way during installation.)

STEP 16. Install shift lever over manual lever shaft and tighten pinch bolt. Install throttle pressure lever over throttle pressure shaft and tighten pinch bolt securely.

STEP 17. Clean oil pan and install in place with new gasket supplied with kit. Install pan bolts and tighten to 150-in. lbs. Check your drain plug if you have one and make sure it is tight!

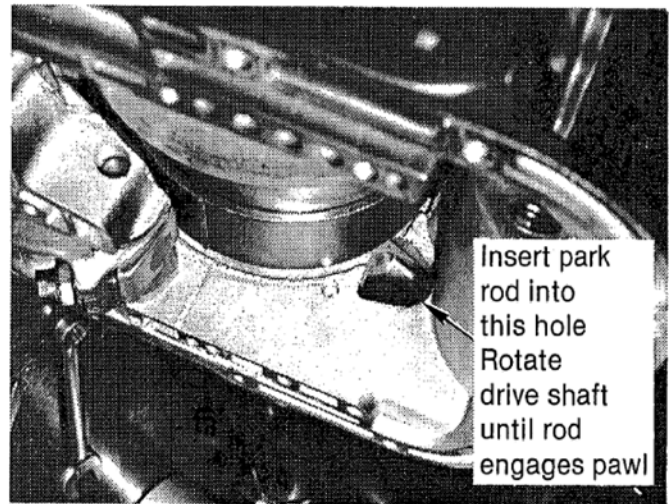

FIGURE 13

STEP 18. Check shifter adjustment. Place shifter in park position. Loosen the pinch bolt on the shifter rod (which is located on the end of the rod away from transmission) and let the rod seek its own position. Tighten the pinch bolt and check the feel of the shifter. The detent position should be close enough to the gate stops in neutral and drive so that the shift selector lever will not remain out of the detent position when placed against gate and released.

STEP 19. Throttle pressure adjustment: Make sure carburetor is off fast idle cam so throttle is in normal idle position. (Hot idle position) Have someone push the throttle lever on the transmission all the way forward. Adjust the throttle pressure rod so there is no backlash between the operating stud on the carburetor and the back of the slot on the throttle pressure linkage.

STEP 20. Lower the vehicle but keep the rear wheels off the ground if possible. Pour four quarts of B&M Trick Shift or Type "F" fluid into the transmission. Trick Shift is superior in lubrication, heat capacity and friction material performance. We recommend Ford fluid over Dexron or Type "A". Start the engine and allow it to idle in neutral. Check the fluid level and fill to the "add" mark. Shift the transmission through all three gears several times. Check the oil level and make sure it is at least at the "add" mark.

STEP 21. Drive the vehicle for one or two miles to thoroughly warm the fluid. Minor adjustments in shift points can be made at this time. Shortening the rod will lower shift points, lengthening the rod will raise shift points. Note: All vehicles must have throttle pressure linkage regardless of intended use. Running this transmission without throttle pressure linkage will damage it. Check fluid level with engine running and shifter in neutral and make sure the level is between the "add" and "full" marks. Do not overfill!!! This will cause foaming and overheating.

**TOOLS REQUIRED FOR TORQUEFLITE
SHIFT IMPROVER KIT INSTALLATION**

- | | |
|--|--------------------------------|
| 1 Speed Handle or Ratchet - 3/8" Drive | 1 3/16" Allen Wrench |
| 1 1/2" Socket - 3/8" drive | 1 6" Flat Blade Screwdriver |
| 1 7/16" Socket - 3/8" drive | 1 Small Flat Blade Screwdriver |
| 1 3/8" 12-point Socket - 3/8" drive | 1 Phillips Blade Screwdriver |
| 1 3/4" Wrench | 1 Torque Wrench 0-250 in. lbs |
| | 1 1/4" Drill Motor |

**TROUBLE SHOOTING GUIDE
TORQUEFLITE**

MALFUNCTION : PROBABLE CAUSE

- Slips : Low fluid level
- Overheating : High fluid level
- Foaming oil at dipstick
or breather : Clogged or blocked cooler
- Erratic Shifting : Throttle pressure link sloppy, loose or
misadjusted, shifter misadjusted, low fluid level, high fluid
level, valve body bolts or end plate screws loose
- Early Shifts : Throttle pressure linkage misadjusted

MALFUNCTION : PROBABLE CAUSE

- Late Shifts : Throttle pressure linkage misadjusted
- Leaks : Clean transmission first and observe, check pan
gasket and bolt torque
- Will not up shift : Throttle pressure linkage too high, Shift
valves burred and sticking, loose bolts
- Soft shifts under power : Throttle pressure linkage too
high, low fluid level (starvation), high fluid level (foaming),
Pressure regulator valve stuck
- Engine revs on 2-3 shift : Check band adjustment

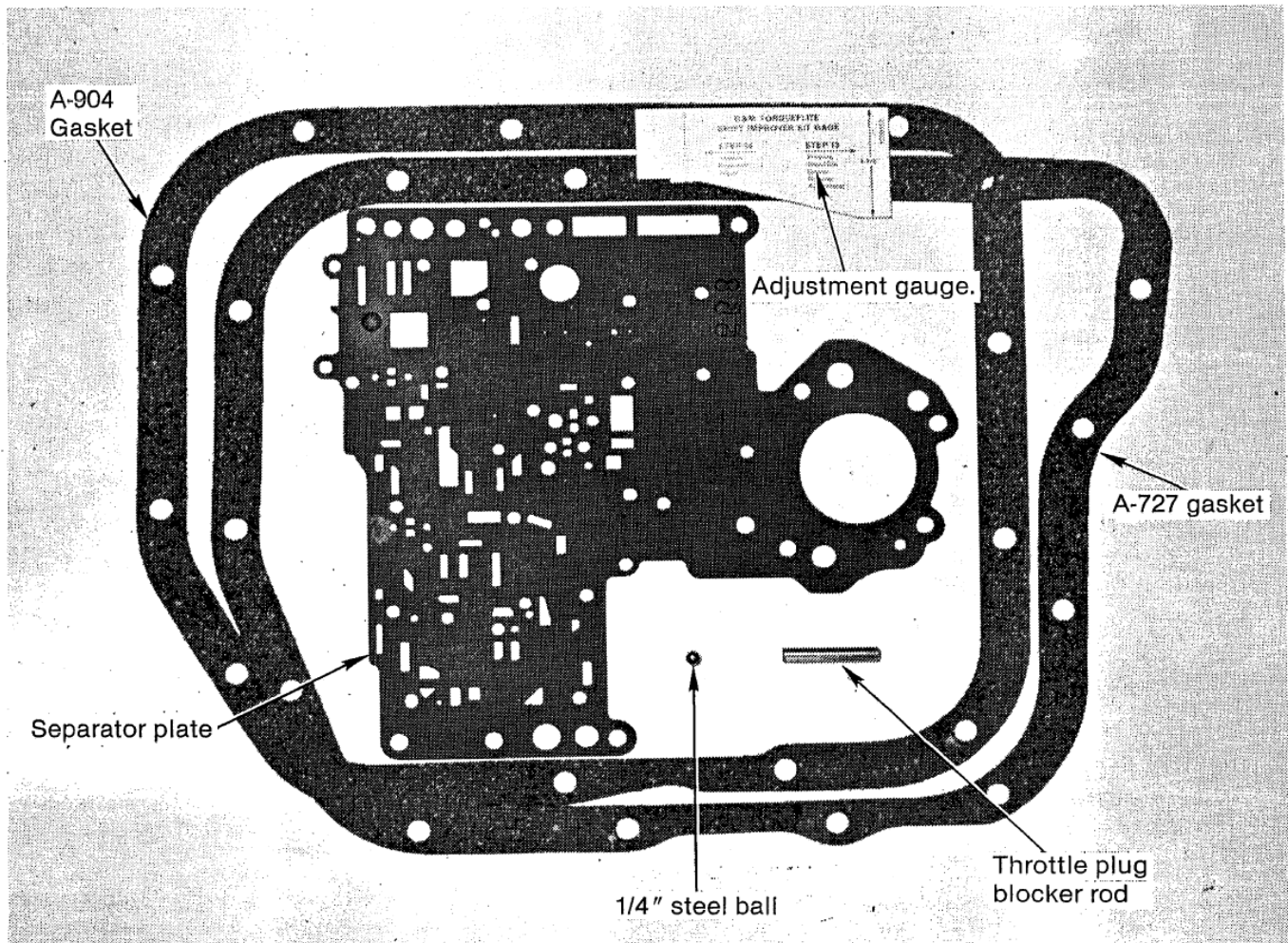

PARTS LIST: A-904 gasket, adjustment gauge, separator plate, A-727 gasket, 1/4" steel ball, throttle plug blocker rod