

Catback installation for KIA Koupe PN 140463



These instructions have been written to help you with the installation of your Borla Performance Exhaust System. Please read this document completely before beginning the installation of your system.

Please compare the parts in the box with the bill of materials provided to assure that you have all the parts necessary for this installation.

To ensure this part number fits your specific model year, please visit our website for the latest model year listings at www.BORLA.com.

Thank you for purchasing a Borla Performance Exhaust System.

Borla Performance Exhaust System (140463) is designed for Kia Koupe w/ 2.0L 4-cylinder engine and automatic or manual transmission.

Borla Performance Industries recommends that an exhaust shop or professional after market parts installer perform the installation of this system. However, if you decide to perform the installation on your own it is recommended that two people are used. This installation should not be performed by one person due to the risk of injury. Ensure the installers use all under car safety precautions including eye protection.

Please take time to read and understand the following...

By installing your Borla Performance Exhaust System, you indicate that you have read this document and you agree with the terms stated below.

It is the responsibility of the purchaser to follow all installation instruction guidelines and safety procedures supplied with your Borla Performance Exhaust System

Borla Performance Industries assumes no responsibility for damages occurring from misuse, abuse, improper installation, improper operation, lack of responsible care, or all previously stated reasons resulting from incompatibility with other manufacturer's products and/or systems.

Included with your Borla Performance Exhaust System is a warranty card. Please read it carefully before you begin any work on

Minimum Required Tool List:

TOOLS:

1. 3/8" Drive Ratchet
2. 3/8" Drive Extension 3"
3. 15mm Deep Well Socket
4. Pry Bar

SHOP SUPPLIES:

- 1 Spray Lubricant

Borla Performance - Bill of Materials

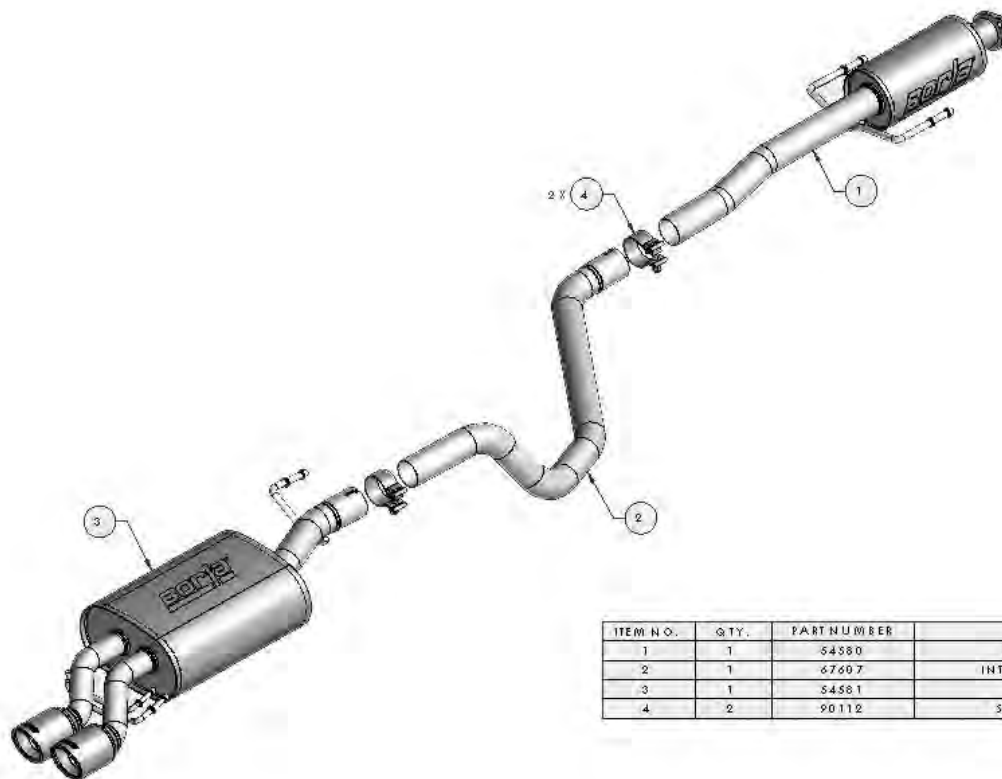

ITEM NO.	QTY.	PART NUMBER	DESCRIPTION
1	1	54580	FRONT MUFFLER ASSEMBLY
2	1	67607	INTERMEDIATE PIPE: Ø2.25 X 47.00"
3	1	54581	REAR MUFFLER ASSEMBLY
4	2	90112	S/S ACCUSEAL CLAMP Ø2.25

Caution!!! *Never work on a hot exhaust system. Serious injury in the form of burns can result* If the vehicle has been in use and the exhaust system is hot, allow vehicle to cool for at least 1 hour. Always wear eye protection when working under any vehicle.

Note: It is our recommendation that you use a hoist or hydraulic lift to facilitate the installation of your new Borla Performance Rear Section Exhaust System.

Taking all under car safety precautions, lift the vehicle using a hoist or hydraulic lift. Once this has been done, you may begin the removal of your old exhaust system from your vehicle.

Note: Before removing the original exhaust system from your vehicle, please compare the parts you have received with the bill of materials provided on the previous page to assure that you have all the parts necessary for the installation of your new Borla Performance Rear Section Exhaust System.

Original System Removal

Note: With a used vehicle, we suggest a penetrating spray lubricant to be applied liberally to all exhaust fasteners and allowing a significant period of time for the chemical to lubricate the threads before attempting to disassemble.

1. Lubricate all the hangers and rubber isolators. Place all hardware to the side for installation of your new Borla exhaust.
2. Remove (2) muffler flange nuts. Keep hardware for re-installation of your new exhaust. (See Fig.1) Slide and remove rubber isolators from hangars and remove front muffler assembly.
3. Remove (2) rear muffler flange nuts. Slide and remove rubber isolators from hangars and remove rear muffler assembly.

Warning: Use extreme caution during installation. Torque all fasteners according to manufacturer's torque values and tightening sequence. **DO NOT** use air impact tools to tighten fasteners on Borla Performance Exhaust Systems. Use of such tools may result in bent flanges or gasket contact areas leading to exhaust leaks.

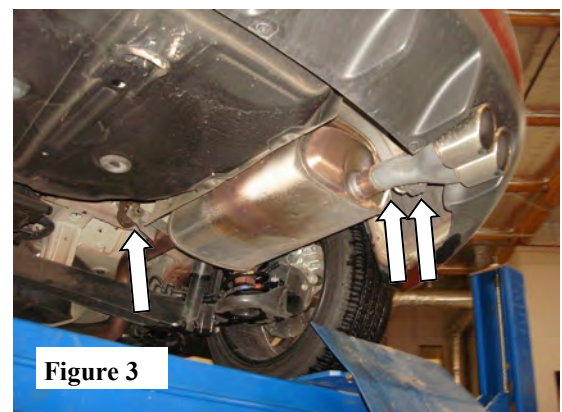
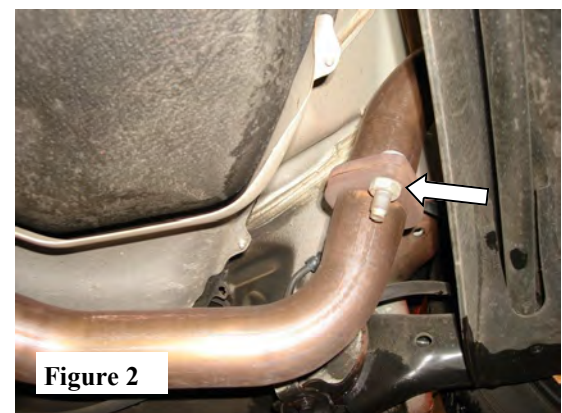
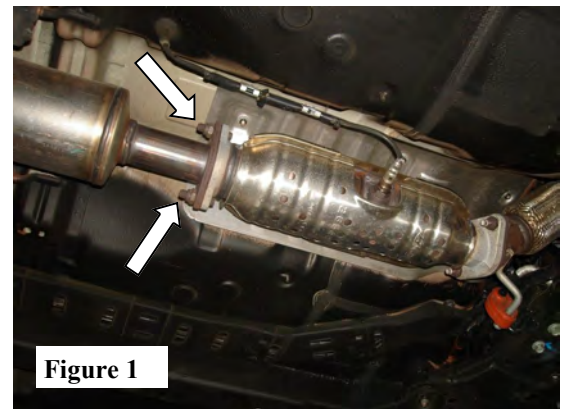

Caution!!! Never work on a hot exhaust system. Serious injury in the form of burns can result! If the vehicle has been in use and the exhaust system is hot, allow vehicle to cool for at least 1 hour. Always wear eye protection when working under any vehicle.

Note: It is our recommendation that you use a hoist or hydraulic lift to facilitate the installation of your new Borla Performance Rear Section Exhaust System.

Taking all under car safety precautions, lift the vehicle using a hoist or hydraulic lift. Once this has been done, you may begin the removal of your old exhaust system from your vehicle.

Note: Before removing the original exhaust system from your vehicle, please compare the parts you have received with the bill of materials provided on the previous page to assure that you have all the parts necessary for the installation of your new Borla Performance Rear Section Exhaust System.

Borla Performance Exhaust System Installation

1. Install Front Muffler Assembly into front flange using bolts and slide hangers into OE rubber isolators. (See Fig. 6) Temporarily hand tighten hardware.
2. Place a clamp over expanded end of Intermediate Pipe and slide into Front Muffler Assembly. Slide hangers into rubber isolators. Lightly tighten clamp over notches. (See Fig. 7)
3. Place a clamp over expanded end of Intermediate Pipe and slide into Front Muffler Assembly. Slide hangers into rubber isolators. Lightly tighten clamp over notches. (See Fig. 8)
4. Using supplied hardware, re-assemble and hand-torque bolts to 18-22 ft. lbs.
5. Check your exhaust for proper clearance under the vehicle and also for tip alignment. (See Fig.7)
6. Start vehicle and check for any leaks. If any leaks are found, determine cause (such as loose hardware or incorrectly positioned clamp) and repair as necessary.

Note: When you first start your vehicle after the installation of your new Borla Performance Exhaust System, there may be some smoke and fumes coming from the system. This is a protective oil based coating used in the manufacturing of mandrel bent performance exhaust tubing. This is not a problem and will disappear within a very short period of time after the exhaust has reached normal operating temperatures.

Figure 6

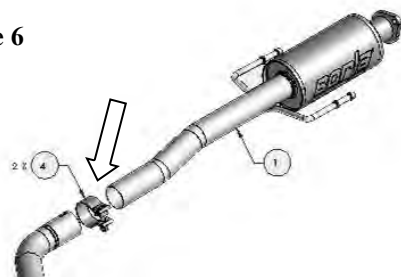

Figure 7

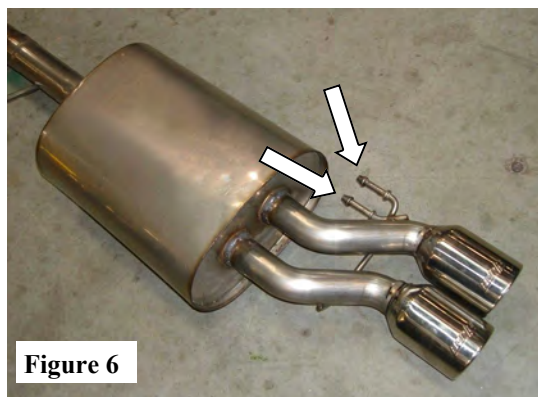
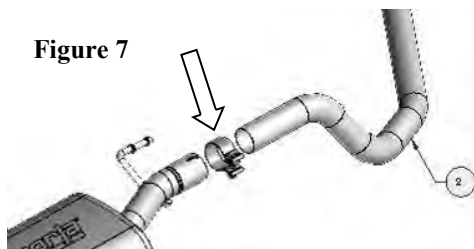

Figure 6



Figure 7