



CURT™

The **FIRST** Name
in Towing Products™

VENTURER

VENTURER BRAKE CONTROL INSTALLATION AND USER GUIDE

For use with 12 volt negative ground systems only
For trailers with two to six brakes

Read, follow and save this guide for future reference



This package includes:

- (1) Brake control module with quick plug
- (1) Mounting bracket
- (4) Mounting bracket screws

One or more of the following may be needed to complete installation:

- Brake control connection harness, supplied with the tow vehicle (if equipped)
- CURT quick plug - custom connector for specific vehicles. See catalog for availability
- CURT part# 51515 - male quick plug with pigtails
- CURT part# 51500 - brake control wiring kit

Key Features

- Display shows brake force output
- Mount anywhere in your vehicle
(Dependable solid state electronics require no leveling)
- Electronic activation ensures smooth stops
- No internal moving parts
- Fully-adjustable power and time (sync)
- Provides automatic and manual trailer braking
- Manual control lever activates brake lights
- Compatible with electronic systems (anti-lock brakes and cruise control)
- Self diagnostic - continually monitors trailer connection and checks for short circuits
- Displays brake system disconnect

Controls and Components

1. Display
2. Sync adjustment
3. Output adjustment
4. Manual control lever
5. Quick plug connector



Disconnect Indication

Should a trailer disconnect occur, either unplugged or wiring failure, the status LED will glow steady red. It will remain red for approximately 10 minutes or until the connection is restored.

If the disconnection was not a result of intentionally unplugging the trailer, check and repair wiring to the trailer brake system.

Output Control

The output control establishes the maximum amount of power available to the trailer brakes.

As the output control is moved to the right, more power will be available to the brakes when the brake pedal is pressed or the manual control is used.

The output control should be adjusted during initial setup, when trailer load changes, when different trailers are used or to adjust for a change in road conditions.

The output setting is shown on the display when a trailer is connected and the brake pedal is pressed or when the manual control lever is actuated.

The output setting is shown as one to eight green bars.

Sync Control

The sync control is located on the left side of the brake control unit and is responsible for adjusting trailer brake aggressiveness. The trailer brakes become more aggressive as the switch is moved toward the front of the tow vehicle.

The sync adjustment has no effect on the manual control. The sync control should be adjusted for individual driver preference or changing road conditions.

The sync setting is shown on the display when a trailer is connected, the brake pedal is pressed or when the manual control lever is activated and the sync control is moved. The sync setting is shown as one to eight bars with a flashing green status LED.

Manual Control

The manual control lever is located on the front left of the brake control unit. It only applies to the trailer brakes. Manual control is used during initial setup and in situations where a slow reduction in speed is desirable.

When the manual control is pushed to the right, the control begins to apply the trailer brakes. The further to the right it is pushed the harder the brakes are applied until the maximum set by the output control is reached.

The output setting will be shown on the display and can be adjusted when using the manual control. The manual control activates the tow vehicle and trailer stoplights.

Display

The display shows the output setting when the control is activated.
It is used to setup and monitor the brake control.

BLANK DISPLAY

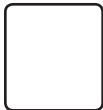

Not activated by
either brake pedal
or manual control

GREEN BARS WITH FLASHING GREEN



Sync setting, 1 to 8 bars
Trailer connected
Brake pedal or
manual activation

SINGLE GREEN

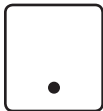

Ready
No trailer connected
Brake pedal or
manual activation

SINGLE RED

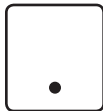

Trailer disconnect
See display modes
error conditions (pg 7)

GREEN BARS

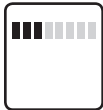

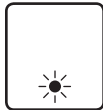

Output: 1 to 8 bars
Trailer connected
Brake pedal or
manual activation

FLASHING RED



Brake circuit overload
or short
See display modes
error conditions, (pg 7)

Error Conditions Troubleshooting Guide

Condition	Display	Probable Cause	Probable Solution
Blank display with brake pedal pushed or manual control activated	Blank 	Tripped circuit breaker, no battery connection B+ or ground	Check battery connections Repair battery connections
Loss of trailer connection	Single Red 	Trailer unplugged, failed wire to trailer	Check tow vehicle to trailer connectors Check and repair brake circuit wiring
Flashing red with brake pedal pushed or manual control lever activated	Flashing Red 	Brake circuit overload or short	Confirm six brake maximum load Locate short circuit and correct

Mounting the Brake Control

NOTE: Avoid mounting the brake control module near a CB radio or other RF transmitter.

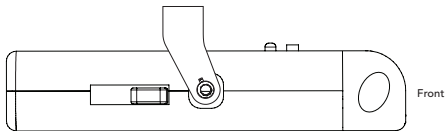

Horizontal

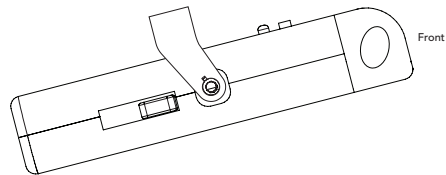

Any angle

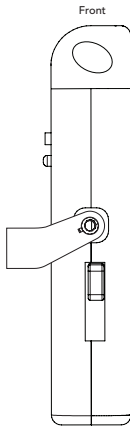

Vertical

1. Determine a suitable mounting location.
Mount the unit securely to a solid surface where it is easily accessible to the driver. The area behind the mounting location must be clear to prevent damage while drilling.
2. Hold the mounting bracket in the position selected and mark hole locations through the slots in the bracket.
3. Using a 1/8" diameter bit, drill holes in the marked locations.
4. With a philips screwdriver, secure the bracket in place using the two screws provided. Be careful not to strip the holes by over-tightening.
5. Mount the brake control unit in the bracket using the two screws provided, as shown in the illustration on page 8.

Wiring

NOTE: Removal of factory supplied quick plug may void warranty.

Most pick-ups and utility vehicles are equipped with a plug from the factory that allows quick brake control installation. Check the owner's manual for plug availability, location and installation.

If the mating plug supplied with the vehicle is no longer available, a CURT quick plug can be used. See the CURT catalog for application information.

For tow vehicles not equipped with a factory brake control plug, we suggest the CURT brake control wiring kit, part# 51500.

WIRING DIAGRAM

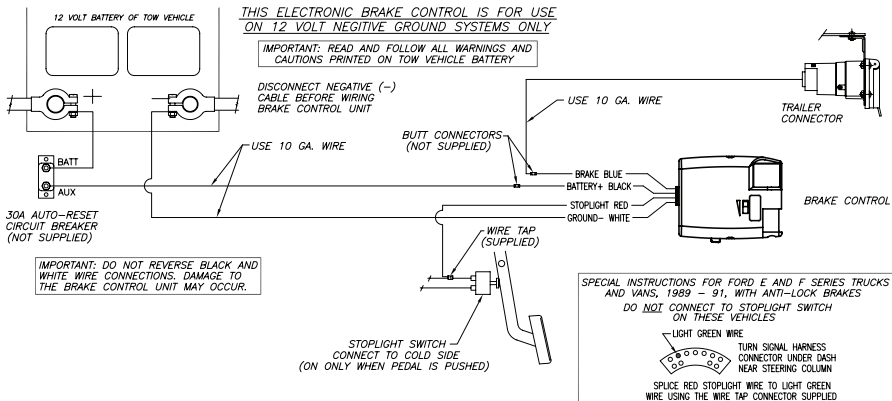

IMPORTANT: Make sure that both positive and ground connections are made directly to the tow vehicle's battery. Connecting to existing wiring or chassis ground, other than the battery terminal, may damage vehicle circuits and could lead to trailer brake failure.

Mount a 30 amp, auto reset, circuit breaker as close to the battery as possible.

IMPORTANT: When passing wire through sheet metal, always go through an existing grommet, add a grommet or use silicone sealer to protect the wire from sharp edges. Feed two 12 gauge, or larger, wires, one white and one black, from the mounted brake control to the battery area. Using a ring terminal, connect the black wire to the 'aux' side of the circuit breaker. Leave the white wire for connection later.

Using a 10/12 gauge butt connector, attach the black wire from the 'aux' side of the circuit breaker to the brake control's black wire. Using a 10/12 gauge butt connector, attach the white wire from the battery area to the brake control's white wire.

Run a 12 gauge, or larger, blue wire from the tow vehicle's trailer plug 'brake' terminal to the brake control. Using a 10/12 butt connector, connect this wire to the brake control's blue wire.

Connect the brake control's red wire to the cold side of the tow vehicle's stoplight switch using a wire tap.

NOTE: When making the stoplight switch connection on Ford / Mercury vehicles, do not connect to the red wire with green stripe. Connect to the light green wire only.

For 1989 - 1991 Ford E and F series vans and trucks with anti-lock brakes, find the crescent shaped connector located on the steering column. The connector has two rows of wires, the wire needed is the light green wire, second from the end in the outside row. See the view shown in the wiring diagram on page 10.

For all other vehicles, use a test probe to find the cold side of the stoplight switch. Probe the switch wires until a wire is found that is only on when the brake pedal is pressed

IMPORTANT: Once a cold side wire is found, test to ensure that the wire is not grounded when the pedal is in the up position. If the wire is grounded, the brake control unit will be destroyed when manual control is used.

Reconnect the tow vehicle's negative battery terminal and attach the white 10 gauge wire previously positioned near the battery to the negative terminal using a ring terminal.

Using 12 gauge, or larger, stranded wire and a ring terminal, connect the 'battery' side of the circuit breaker to the positive battery terminal.

Secure all loose wires with cable ties so that they will not be damaged and reconnect the battery. See vehicle's owner's manual for special re-connection instructions.

To test installation, without a trailer connected, push the brake pedal. A single green status LED should light up on the display. If the green LED does not light or if any other LED does light, see display modes error condition section of this guide (page 16).

Setup

Preliminary adjustments: With the trailer connected, press and hold the brake pedal, the display will show the output setting.

Adjust the output control left or right until three green bars are displayed. Move the sync control to near center position.

Test Drive

In an open area, such as a large parking lot, drive forward and apply the trailer brakes using the manual control. If the trailer brakes are weak adjust the output control to the right. If the trailer brakes jerk or lockup adjust the output control to the left.

Repeat this step until firm braking is felt without lockup.

Once the output is set, drive forward and press brake pedal. The tow vehicle and trailer should both make smooth stops. If the stops seems slow and more aggressive braking is desired, move the sync control toward the front of the vehicle while holding the brake pedal. If the stop seems too aggressive adjust the sync control toward the rear of the vehicle while holding the brake pedal. Make several stops at various speeds and adjust sync until stops are smooth and firm. Slight adjustment the output control may also be desirable.

Helpful Tips

Light pressure on the brake pedal will activate the trailer's brakes with no effect on the tow vehicle's brakes. This is useful for gradual slowing on steep grades or before stops.

Periodic adjustment of the sync and output controls may be necessary to correct for changing road conditions, trailer loading, brake wear and / or driver preference.

In some applications, when towing with hazard flashers on, the display will flash with the hazard flashers. If the brake control is set aggressively this may be felt in the trailer brakes.

Bench Test Instructions

Wire as shown below.

Bench Test Wiring

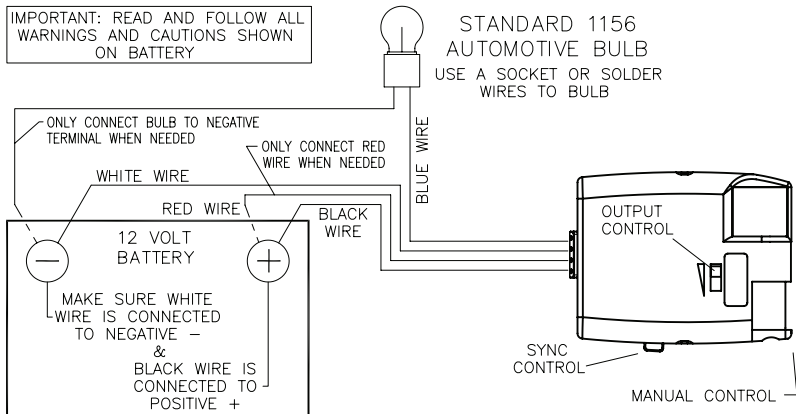

Set the output control to maximum and set the sync control to minimum.

NOTE: If at any time during the bench test the red LED flashes, make sure that the blue 'brake' wire is not shorted to the 'negative' battery terminal or the white 'battery' wire.

Test Standby Condition

Hold the red 'stoplight' wire on the '+' battery terminal. The display should show a single green LED. This indicates correct wiring and that the control is ready.

Disconnect the red 'stoplight' wire from the battery.

Test Brake Pedal Activation

Ground the light bulb to the 'negative' terminal of the battery.

Re-attach the red 'stoplight' wire to the 'positive' battery terminal.

The display should step up to eight green bars and the bulb should start dim and slowly get brighter.

With the red wire still hooked up, slowly move the output control left. The display should step down to zero or one green bar and the bulb should dim and go off.

Slowly move the output control back to the right. The display should step up to eight green bars and the bulb should return to full brightness.

Move the sync control all the way forward.

Disconnect and reconnect the red wire. The bulb should light brightly with no delay, the display should step to eight green bars quickly. Disconnect the red wire.

Test Manual Activation

With the output control still set at maximum, slowly activate the manual control slide button. The bulb should start dim and get brighter and the display should step up to eight green bars as the manual control is pushed.

While holding the manual control all the way in, slide the output control left and right. As the output changes the bulb should go bright and dim and the display should follow the bulb brightness.

If the brake control unit does not function as described, return it for service or replacement.

NOTES
