

11110**KIA SOUL****7/17/2012****GROSS LOAD CAPACITY WHEN USED AS A WEIGHT CARRYING HITCH: 2,000 LBS. TRAILER WEIGHT & 200 LBS. TONGUE WEIGHT.*******DO NOT EXCEED VEHICLE MANUFACTURER'S RECOMMENDED TOWING CAPACITY.*******WARNING: ALL NON-TRAILER LOADS APPLIED TO THIS PRODUCT MUST BE SUPPORTED BY AUXILIARY STABILIZING STRAPS.****** FAILURE TO PROPERLY SUPPORT NON-TRAILER LOADS WILL VOID PRODUCT WARRANTY******HAVING INSTALLATION QUESTIONS? CALL TECHNICAL SUPPORT AT 1-800-798-0813**

Parts List			
ITEM	QTY	PART NUMBER	DESCRIPTION
1	6	M10 - 1.25 x 30	HEX BOLT
2	6	7/16"	CONICAL TOOTHED WASHER

TOOLS REQUIRED
PHILLIPS SCREWDRIVER
FLAT BLADE SCREWDRIVER
14 AND 17mm SOCKETS
12" EXTENSION
RATCHET
TORQUE WRENCH

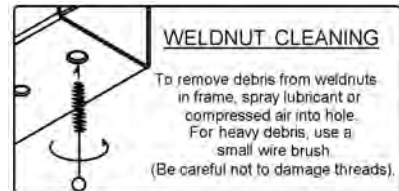
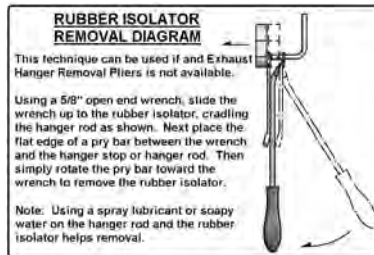
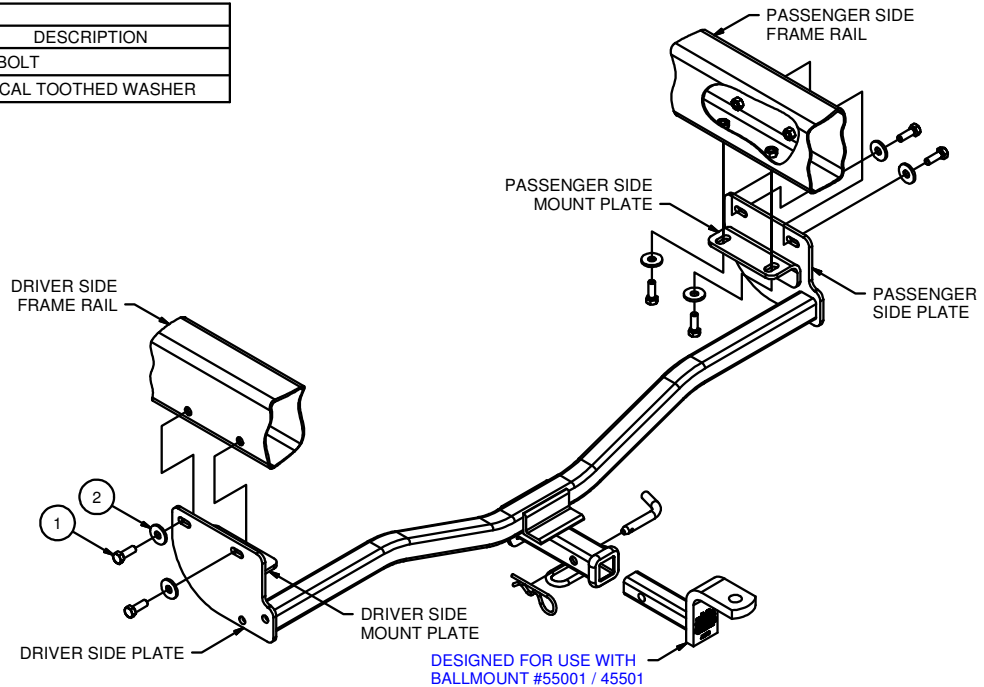

HITCH WEIGHT: 29 LBS.
 INSTALL TIME: 30 MINUTES
 INSTALL NOTES:
 - NO DRILLING REQUIRED
 - LOWER EXHAUST

INSTALLATION STEPS

NOTE: To ease installation, remove the splash shields in the rear wheel wells by removing the (3) push fasteners and (3) screws securing them. Also remove the (3) push fasteners securing the bottom of the bumper cover.

1. Lower the exhaust by removing the (2) rearmost rubber isolators from the hangers. (See Rubber Isolator Removal Diagram.)
2. Remove the (4) bolts securing the tow hook at the passenger side frame rail. Return the tow hook and fasteners to the vehicle owner.
3. Raise the hitch into place by positioning the passenger side plate above the tail pipe and sliding the main body between the tail pipe and the rear bumper cover. Position the mount plates against the bottom of the frame rails and align the holes in the side plates with the holes in the sides of the frame rails.
4. Secure the hitch using a 7/16" conical toothed washers and M10 x 1.25 x 30mm hex bolts through the sideplates and into each weld nut in the outboard sides of the frame rails as shown.
5. Install the remaining 7/16" conical toothed washers and M10 x 1.25 x 30mm hex bolts through the passenger side mount plate into the (2) weld nuts in the passenger side frame rail as shown.
6. Torque all hardware to 48 ft-lbs.
7. Reinstall the splash shields into the wheel wells and the rubber exhaust isolators onto the hangers.

PERIODICALLY CHECK THIS RECEIVER HITCH TO ENSURE THAT ALL FASTENERS ARE TIGHT AND THAT ALL STRUCTURAL COMPONENTS ARE SOUND.

Curt Manufacturing Inc., warrants this product to be free of defects in material and/or workmanship at the time of retail purchase by the original purchaser. If the product is found to be defective, Curt Manufacturing Inc., may repair or replace the product, at their option, when the product is returned, prepaid, with proof of purchase. Alteration to, misuse of, or improper installation of this product voids the warranty. Curt Manufacturing Inc.'s liability is limited to repair or replacement of products found to be defective, and specifically excludes liability for incidental or consequential loss or damage.