



Safety glasses should be worn at all times while installing this product.

YEARS: 2013-PRESENT

MAKE: HYUNDAI

MODEL: ELANTRA GT

STYLE: 5 DOOR

**WARNING: NEVER EXCEED YOUR VEHICLE MANUFACTURER'S RECOMMENDED TOWING CAPACITY**







**WEIGHT CARRYING:**  
 TRAILER WEIGHT: 2,000 LBS.  
 TONGUE WEIGHT: 200 LBS.

**WARNING:**  
 WE RECOMMEND THE USE OF 18050 STABILIZING STRAPS FOR ALL NON-TRAILER (WHEEL-LESS) LOADS. PLEASE SEE THE CURT CATALOG OR VISIT US ONLINE AT [WWW.CURTMFG.COM](http://WWW.CURTMFG.COM) FOR FURTHER INFORMATION.

**INSTALLATION TIME: 25 MIN.**

THE INSTALL TIME LISTED IS FOR PROFESSIONAL INSTALLERS. IF YOU ARE HESITANT TO UNDERTAKE THIS TASK ON YOUR OWN, CONTACT AN AUTHORIZED CURT INSTALLER FOR ADDITIONAL ASSISTANCE.



**INSTALLATION REQUIRES:**

 RATCHET	 6" SOCKET EXTENSION	 14mm 13mm 12mm 3/4" SOCKET
 TORQUE WRENCH	 POWER DRILL	 DRILL BIT 7/16 in
 SAFETY GLASSES		

**INSTALLATION TIPS:**

- BEFORE YOU BEGIN INSTALLATION, READ ALL INSTRUCTIONS THOROUGHLY.
- TO EASE INSTALLATION, 2 PEOPLE MAY BE REQUIRED.
- USING PROPER TOOLS WILL GREATLY IMPROVE THE QUALITY OF THE INSTALL AND REDUCE THE TIME REQUIRED.
- NEED HELP OR HAVE SOME QUESTIONS? CALL TECHNICAL SUPPORT AT 800.798.0813

**LEVEL OF DIFFICULTY: MODERATE**

EASY	MODERATE	CHALLENGING
	-HOLE ENLARGEMENT	
	- LOWER EXHAUST	

**VEHICLE PHOTO:**



REPRESENTATIVE PHOTO

**HITCH ILLUSTRATION:**

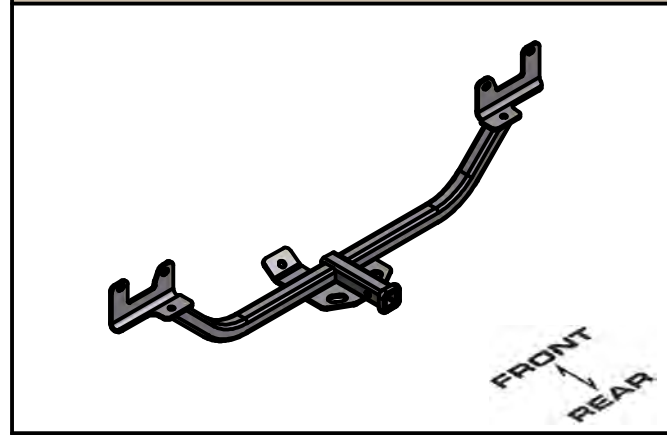

MAKE SURE YOUR HITCH MATCHES

**PERIODICALLY CHECK THIS RECEIVER HITCH TO ENSURE ALL FASTENERS ARE TIGHT AND ALL STRUCTURAL COMPONENTS ARE SOUND**

CURT Manufacturing LLC. warrants this product to be free of defects in material and/or workmanship at the time of retail purchase by the original purchaser. If the product is found to be defective, Curt Manufacturing LLC. may repair or replace the product at their option, when the product is returned, prepaid, with proof of purchase. Alteration to, misuse of, or improper installation of this product voids the warranty. Curt Manufacturing LLC's liability is limited to repair or replacement of products found to be defective, and specifically excludes liability for incidental or consequential loss or damage.

For more information log onto [www.curtmfg.com](http://www.curtmfg.com), & for helpful towing tips log onto [www.hitchinfo.com](http://www.hitchinfo.com)

## INSTALLATION WALKTHROUGH:

Parts List			
ITEM	QTY	PART NUMBER	DESCRIPTION
1	1	1/2-13 x 1 3/4	CARRIAGE BOLT
2	1	HFN 1213, GR8	HEX FLANGE NUT
3	1	CM-SP6	.250 x 1.00 x 3.00" SQUARE HOLE SPACER
4	4	M8-1.25 x 35	HEX BOLT
5	4	3/8"	CONICAL TOOTHED WASHER

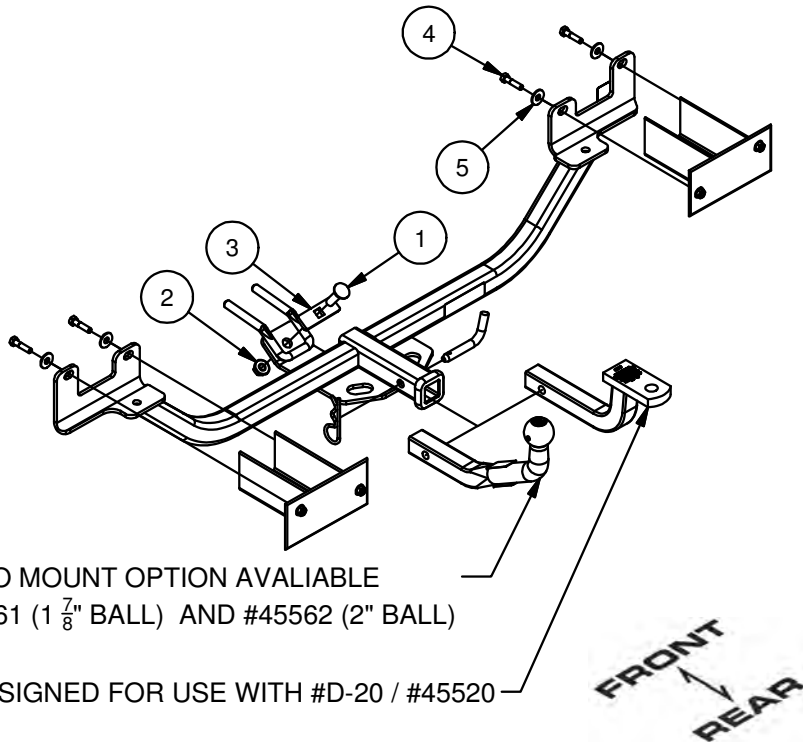

1. Lower exhaust by disconnecting two rubber isolaters, see diagram.

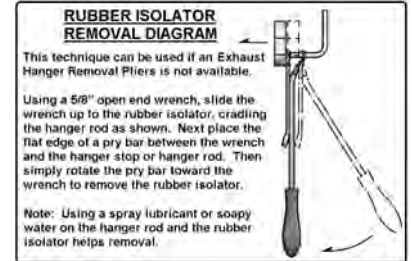

2. Remove one 12mm nut from the bracket holding the module.

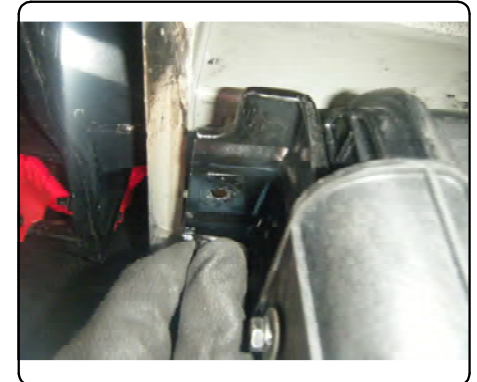

## INSTALLATION WALKTHROUGH:

3. Lower module and enlarge the hole to 7/16".

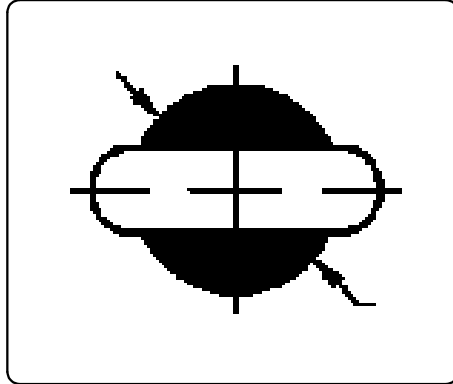

4. Remove four 8mm socket bolts from bumper support.



5. Position hitch in place and use the 4 8mm bolts with washer and lock nut provided.



6. Install 1/2" carriage bolt with spacer through tow hook and lightly tighten nut.





## INSTALLATION WALKTHROUGH:

7. Torque all 8mm bolts to 25lb-ft, and torque the 1/2" nut to 110lb-ft.



9. Reinstall bracket with the 12mm socket nut, torque to 12lb-ft.



8. Reinstall exhaust isolators.



10. Installation complete.

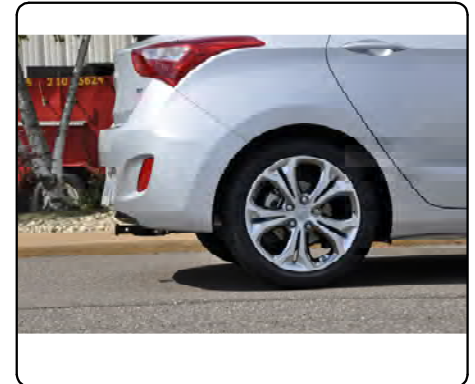

**11314****HYUNDAI ELANTRA GT****3/14/2014****GROSS LOAD CAPACITY WHEN USED AS A WEIGHT CARRYING HITCH: 2,000 LBS. TRAILER WEIGHT & 200 LBS. TONGUE WEIGHT.**

\*\*\*DO NOT EXCEED VEHICLE MANUFACTURER'S RECOMMENDED TOWING CAPACITY.\*\*\*

**WARNING: ALL NON-TRAILER LOADS APPLIED TO THIS PRODUCT MUST BE SUPPORTED BY 18050 STABILIZING STRAPS.**

\*\* FAILURE TO PROPERLY SUPPORT NON-TRAILER LOADS WILL VOID PRODUCT WARRANTY\*\*

**HAVING INSTALLATION QUESTIONS? CALL TECHNICAL SUPPORT AT 1-800-798-0813**

Parts List				
ITEM	QTY	PART NUMBER	DESCRIPTION	
1	1	1/2-13 x 1 3/4	CARRIAGE BOLT	
2	1	HFN 1213, GR8	HEX FLANGE NUT	
3	1	CM-SP6	.250 x 1.00 x 3.00" SQUARE HOLE SPACER	
4	4	M8-1.25 x 35	HEX BOLT	
5	4	3/8"	CONICAL TOOTHED WASHER	

TOOLS REQUIRED
RATCHET
6" SOCKET EXTENSION
12mm, 13mm, 14mm, 3/4 in SOCKET
TORQUE WRENCH
DRILL
7/16 in DRILL BIT

**RUBBER ISOLATOR  
REMOVAL DIAGRAM**

This technique can be used if an Exhaust Hanger Removal Pliers is not available.

Using a 5/8" open end wrench, slide the wrench up to the rubber isolator, cradling the hanger rod as shown. Next place the flat edge of a pry bar between the wrench and the hanger stop or hanger rod. Then simply rotate the pry bar toward the wrench to remove the rubber isolator.

Note: Using a spray lubricant or soapy water on the hanger rod and the rubber isolator helps removal.

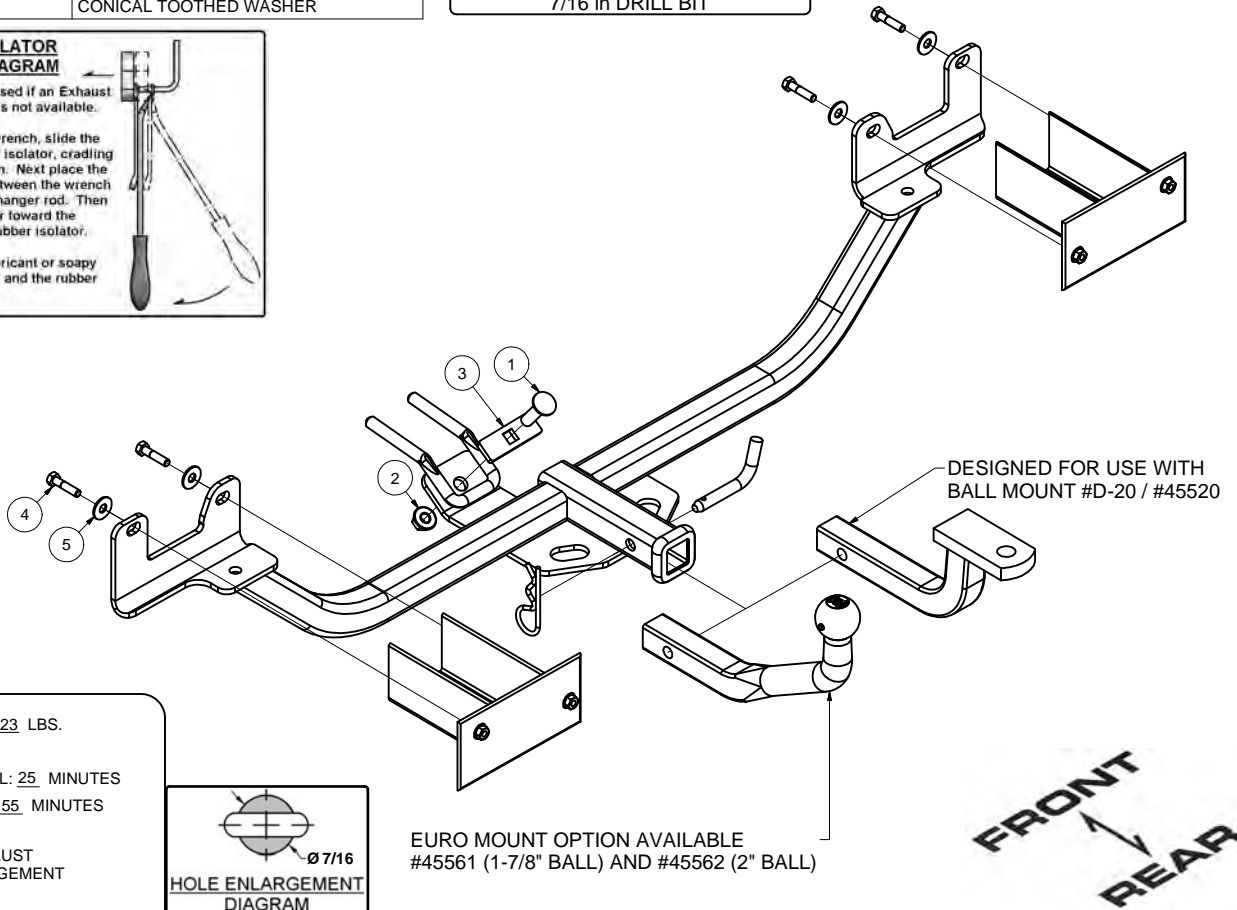

HITCH WEIGHT: 23 LBS.

**INSTALL TIME**

PROFESSIONAL: 25 MINUTES

NOVICE (DIY): 55 MINUTES

**INSTALL NOTES:**

- LOWER EXHAUST
- HOLE ENLARGEMENT

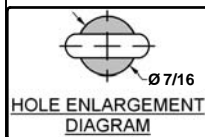
EURO MOUNT OPTION AVAILABLE  
#45561 (1-7/8" BALL) AND #45562 (2" BALL)**INSTALLATION STEPS**

1. Lower exhaust by disconnecting two rubber isolators see diagram.
2. Remove one 12mm nut from the bracket holding the module on the rear driverside frame rail.
3. Lower module and enlarge the hole to 7/16".
4. Remove (4) 8mm socket bolts from bumper support.
5. Position hitch in place and use the (4) 8mm bolts with washer and lock nut provided and lightly tighten.
6. Install 1/2" carriage bolt with spacer through tow hook and lightly tighten.
7. Torque all 8mm bolts to 25lb-ft, and torque the 1/2" nut to 110lb-ft.
8. Reinstall exhaust isolators, and reinstall bracket with the 12mm nut, torque to 12lb-ft.

PERIODICALLY CHECK THIS RECEIVER HITCH TO ENSURE THAT ALL FASTENERS ARE TIGHT AND THAT ALL STRUCTURAL COMPONENTS ARE SOUND.

Curt Manufacturing LLC., warrants this product to be free of defects in material and/or workmanship at the time of retail purchase by the original purchaser. If the product is found to be defective, Curt Manufacturing LLC., may repair or replace the product, at their option, when the product is returned, prepaid, with proof of purchase. Alteration to, misuse of, or improper installation of this product voids the warranty. Curt Manufacturing LLC.'s liability is limited to repair or replacement of products found to be defective, and specifically excludes liability for incidental or consequential loss or damage.