

11327 2003 - 2007 HONDA ACCORD (SEDAN, COUPE, HYBRID)

9/24/2012

GROSS LOAD CAPACITY WHEN USED AS A WEIGHT CARRYING HITCH: 2,000 LBS. TRAILER WEIGHT & 200 LBS. TONGUE WEIGHT.
DO NOT EXCEED VEHICLE MANUFACTURER'S RECOMMENDED TOWING CAPACITY.

Parts List			
ITEM	QTY	PART NUMBER	DESCRIPTION
1	1	7_16 FISHWIRE	7/16" FISHWIRE
2	1	HFN 1213	HEX FLANGE NUT
3	1	1/2-13 x 1 3/4	CARRIAGE BOLT
4	2	7/16-14	HEX FLANGE NUT
5	2	7/16-14 x 1 1/2	CARRIAGE BOLT
6	2	CM-SP11	.250 x 1.00 x 2.50" SQUARE HOLE SPACER

TOOLS REQUIRED

3/8" DRIVE RATCHET
3/4" - 3/8" DRIVE SOCKET
11/16" - 3/8" DRIVE SOCKET
10mm - 3/8" DRIVE SOCKET
3/8" DRIVE TORQUE WRENCH
POWER DRILL WITH 5/8" BIT

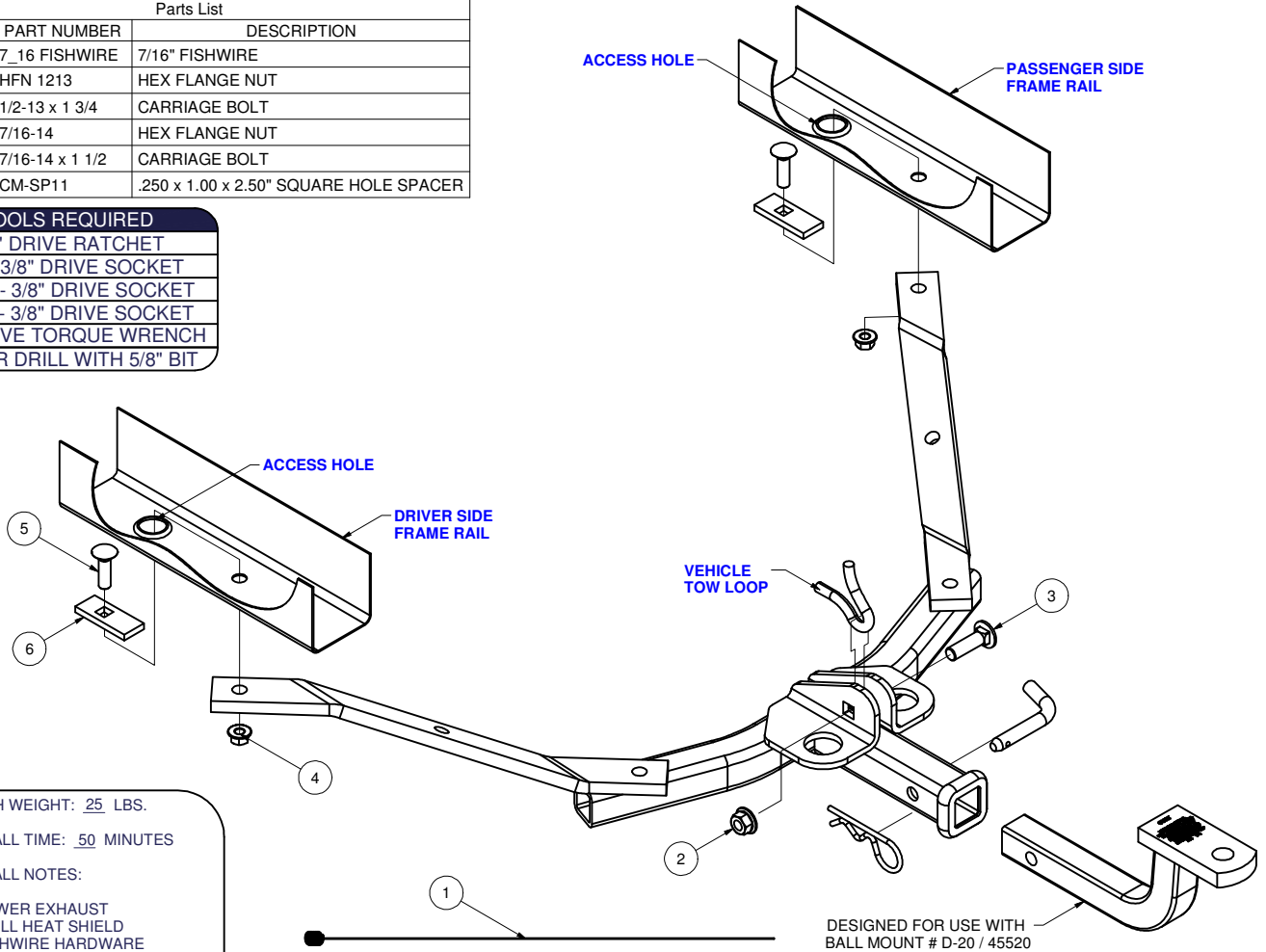

HITCH WEIGHT: 25 LBS.

INSTALL TIME: 50 MINUTES

INSTALL NOTES:

- LOWER EXHAUST
- DRILL HEAT SHIELD
- FISHWIRE HARDWARE

INSTALLATION STEPS

- 1) Lower exhaust. Be careful not to allow mufflers to fall under their own weight.
- 2) Mark and drill a 5/8" hole in **heat shield(s)** 4 1/2" back from the forward most hole on the frame rail. (**NOTE:** Mark holes then hold hitch in position to check before drilling). Remove heat shields to drill hole.
- 3) Use supplied fishwire and "pull" the 7/16" carriage bolts and spacers through the access hole and into the existing hole in frame. Repeat for other side.
- 4) Re-install heat shields once the bolts are in position.
- 5) Raise hitch into position over vehicle tow loop and secure with 1/2" carriage bolt and flange nut as shown, finger tighten. (**NOTE:** Support hitch so receiver tube does not rotate and hit the bumper fascia.)
- 6) Rotate hitch straps to the frame rails, being careful not to push the bolt assemblies back into the frame and secure with 7/16" flange nuts.
- 7) Torque all 7/16" fasteners to 70 lb-ft and all 1/2" fasteners to 110 lb-ft.
- 8) Raise exhaust back into position and re-install rubber isolators.

PERIODICALLY CHECK THIS RECEIVER HITCH TO ENSURE THAT ALL FASTENERS ARE TIGHT AND THAT ALL STRUCTURAL COMPONENTS ARE SOUND.

Curt Manufacturing Inc., warrants this product to be free of defects in material and/or workmanship at the time of retail purchase by the original purchaser. If the product is found to be defective, Curt Manufacturing Inc., may repair or replace the product, at their option, when the product is returned, prepaid, with proof of purchase. Alteration to, misuse of, or improper installation of this product voids the warranty. Curt Manufacturing Inc.'s liability is limited to repair or replacement of products found to be defective, and specifically excludes liability for incidental or consequential loss or damage.