

11372 / 29134

LEXUS IS250 / IS350 AND GS 350 / GS 430

11/28/2016

GROSS LOAD CAPACITY WHEN USED AS A WEIGHT CARRYING HITCH: 2,000 LBS. TRAILER WEIGHT & 200 LBS. TONGUE WEIGHT.

DO NOT EXCEED VEHICLE MANUFACTURER'S RECOMMENDED TOWING CAPACITY.

WARNING: ALL NON-TRAILER LOADS APPLIED TO THIS PRODUCT MUST BE SUPPORTED BY AUXILIARY STABILIZING STRAPS.

** FAILURE TO PROPERLY SUPPORT NON-TRAILER LOADS WILL VOID PRODUCT WARRANTY**

HAVING INSTALLATION QUESTIONS? CALL TECHNICAL SUPPORT AT 1-800-798-0813

TOOLS REQUIRED

- 8 & 17mm SOCKETS
- 12" EXTENSION
- RATCHET
- TORQUE WRENCH
- TIN SNIPS

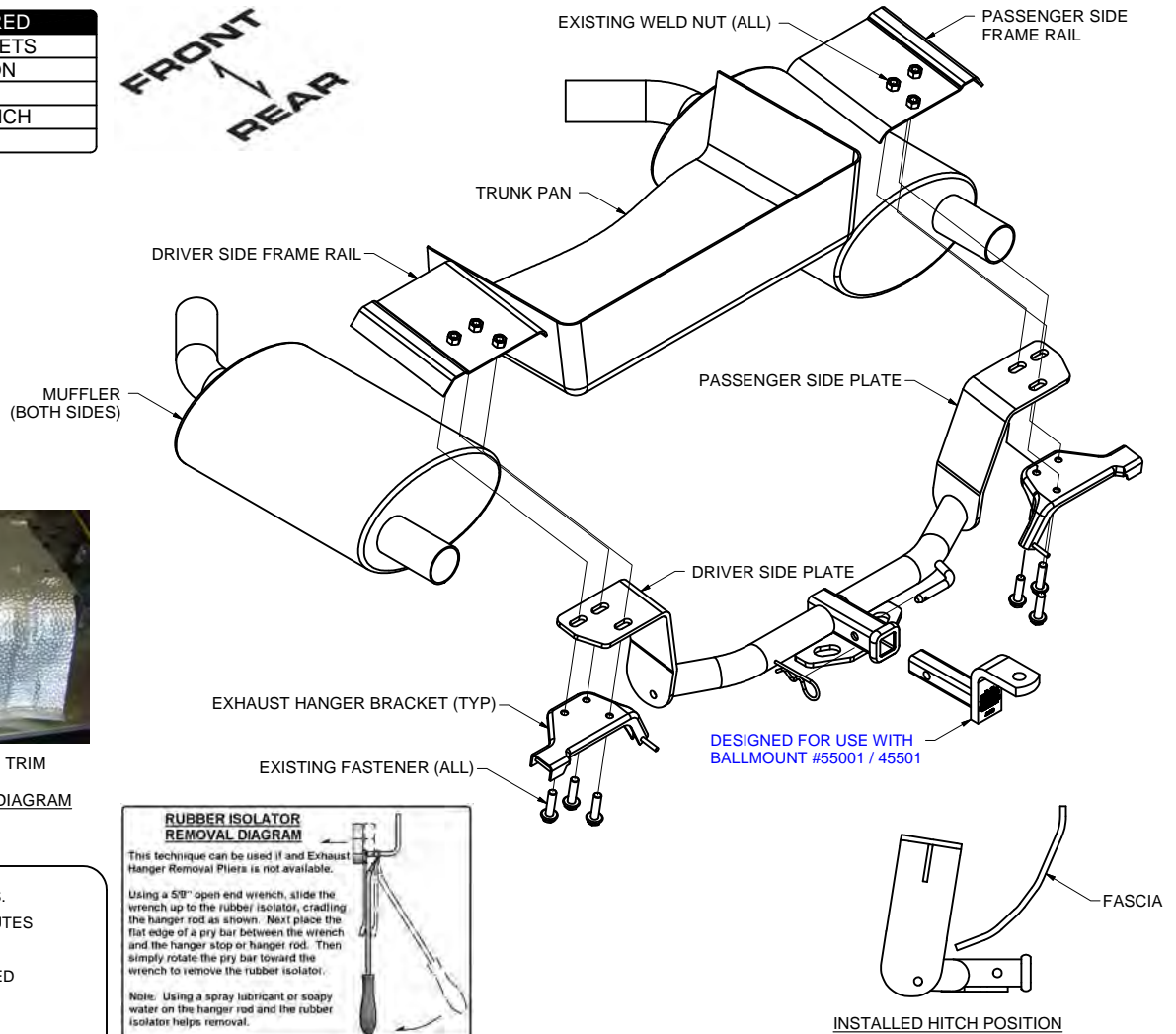

3-1/2" AREA TO TRIM
HEAT SHIELD TRIMMING DIAGRAM

- HITCH WEIGHT: 24 LBS.
 INSTALL TIME: 45 MINUTES
 INSTALL NOTES:
 - NO DRILLING REQUIRED
 - LOWER EXHAUST
 - TRIM HEAT SHIELDS

INSTALLATION STEPS

1. Lower the exhaust by removing the (2) rearmost rubber isolators from the hanger bracket on each muffler, allowing the exhaust to hang. (See Rubber Isolator Removal Diagram.)
2. Remove the (6) hex flange bolts securing the exhaust hanger brackets and remove the brackets. Save the bolts and brackets for use in Step 5.
3. Remove the (4) nuts securing each heat shield and remove the heat shields from the vehicle. Trim the heat shields to clear the hitch side plates as shown above if needed. (See Heat Shield Trimming Diagram.)
4. Reinstall the heat shields with the nuts removed in Step 3.
5. Raise the hitch into position against the frame rails and reinstall the exhaust hanger brackets using the (6) hex flange bolts removed in Step 2. (Note: Hitch is sandwiched between the frame rails and exhaust hanger brackets.)
6. Torque all M12 hardware to 79 ft-lbs.
7. Raise the exhaust and reinstall the (4) rubber isolators. **Note:** On the GS350, bend the lower rear edge of the heat shields away from the side plates.

PERIODICALLY CHECK THIS RECEIVER HITCH TO ENSURE THAT ALL FASTENERS ARE TIGHT AND THAT ALL STRUCTURAL COMPONENTS ARE SOUND.

Curt Manufacturing Inc., warrants this product to be free of defects in material and/or workmanship at the time of retail purchase by the original purchaser. If the product is found to be defective, Curt Manufacturing Inc., may repair or replace the product, at their option, when the product is returned, prepaid, with proof of purchase. Alteration to, misuse of, or improper installation of this product voids the warranty. Curt Manufacturing Inc.'s liability is limited to repair or replacement of products found to be defective, and specifically excludes liability for incidental or consequential loss or damage.