

11390 FORD FUSION, MERCURY MILAN & LINCOLN MKZ

7/18/2012

GROSS LOAD CAPACITY WHEN USED AS A WEIGHT CARRYING HITCH: 2,000 LBS. TRAILER WEIGHT & 200 LBS. TONGUE WEIGHT.

*****DO NOT EXCEED VEHICLE MANUFACTURER'S RECOMMENDED TOWING CAPACITY.*****

WARNING: ALL NON-TRAILER LOADS APPLIED TO THIS PRODUCT MUST BE SUPPORTED BY AUXILIARY STABILIZING STRAPS.

**** FAILURE TO PROPERLY SUPPORT NON-TRAILER LOADS WILL VOID PRODUCT WARRANTY****

HAVING INSTALLATION QUESTIONS? CALL TECHNICAL SUPPORT AT 1-800-798-0813

Parts List			
ITEM	QTY	PART NUMBER	DESCRIPTION
1	4	1/2-13 x 1 1/4	CARRIAGE BOLT
2	4	CM-SP19	.250 x 1.25 x 3.00" SQUARE HOLE SPACER
3	4	HFN 1213	HEX FLANGE NUT
4	2	1_2 FISHWIRE	1/2" FISHWIRE

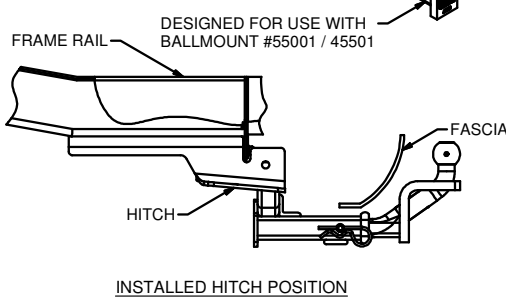
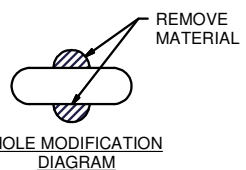
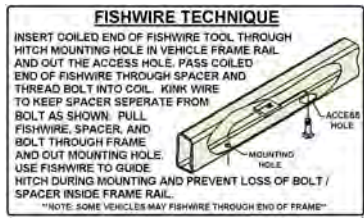
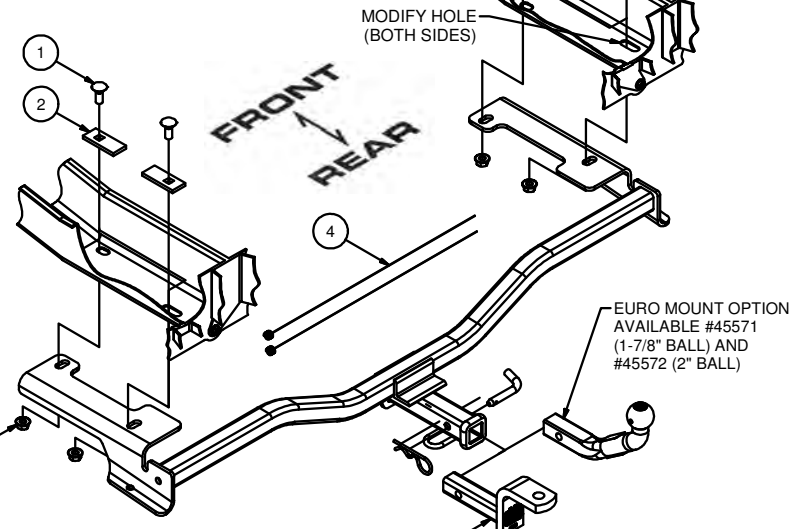
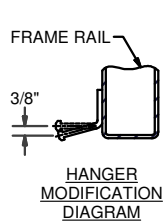
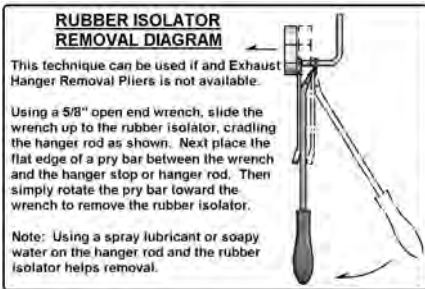
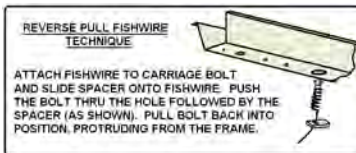

HITCH WEIGHT: 32 LBS.
 INSTALL TIME:
 PROFESSIONAL: 30 MINUTES
 NOVICE (DIY): 60 MINUTES
 INSTALL NOTES:
 - LOWER EXHAUST
 - ENLARGE HOLES
 - FISHWIRE HARDWARE
 - MODIFY EXHAUST HANGERS

TOOLS REQUIRED
3/4" SOCKET
RATCHET
TORQUE WRENCH
DIE GRINDER

INSTALLATION STEPS

- Lower the exhaust by removing the (3) rearmost exhaust hangers from the rubber isolators. Support the exhaust to prevent damage. Next, remove the rearmost rubber isolators from the frame mounted hangers and bend each exhaust hanger down 3/8" using a box end wrench for leverage. (See Rubber Isolator Removal and Hanger Modification Diagrams.)
- Enlarge the access holes near the rear panel to allow the insertion of carriage bolts into the frame rails. (See Hole Modification Diagram.)
- Fishwire a CM-SP19 spacer and 1/2"-13 carriage bolt through the enlarged access hole and out the forward most hole in each frame rail as shown. (See Fishwire Technique.)
- Reverse fishwire CM-SP19 spacers and 1/2"-13 carriage bolts into the enlarged access hole in each frame rail as shown. (See Reverse Pull Fishwire Technique.)
- Raise the hitch into position and loosely secure it to the frame rails with 1/2" flange nuts, taking care not to push the hardware into the frame rails.
- Torque all 1/2" hardware to 110 ft-lbs.
- Raise the exhaust and re-install the rubber isolators removed in Step 1.

PERIODICALLY CHECK THIS RECEIVER HITCH TO ENSURE THAT ALL FASTENERS ARE TIGHT AND THAT ALL STRUCTURAL COMPONENTS ARE SOUND.

Curt Manufacturing Inc., warrants this product to be free of defects in material and/or workmanship at the time of retail purchase by the original purchaser. If the product is found to be defective, Curt Manufacturing Inc., may repair or replace the product, at their option, when the product is returned, prepaid, with proof of purchase. Alteration to, misuse of, or improper installation of this product voids the warranty. Curt Manufacturing Inc.'s liability is limited to repair or replacement of products found to be defective, and specifically excludes liability for incidental or consequential loss or damage.