



# 11422 INSTALLATION INSTRUCTIONS



Safety glasses should be worn at all times while installing this product.

YEARS: 2015-PRESENT  
YEARS: 2017-PRESENT

MAKE: VOLKSWAGEN  
MAKE: VOLKSWAGEN

MODEL: GOLF SPORTWAGEN  
MODEL: GOLF ALLTRACK

STYLE: WAGON  
STYLE: WAGON

**WARNING: NEVER EXCEED YOUR VEHICLE MANUFACTURER'S RECOMMENDED TOWING CAPACITY**  
For more information log onto [www.curtmfg.com](http://www.curtmfg.com) & for helpful towing tips log onto [www.hitchinfo.com](http://www.hitchinfo.com)







**WEIGHT CARRYING:** TRAILER WEIGHT: 2,000 LBS.  
TONGUE WEIGHT: 200 LBS.

**WARNING:**  
WE RECOMMEND THE USE OF 18050 STABILIZING STRAPS FOR ALL NON-TRAILER (WHEEL-LESS) LOADS.  
PLEASE SEE THE CURT CATALOG OR VISIT US ONLINE AT [WWW.CURTMFG.COM](http://WWW.CURTMFG.COM) FOR FURTHER INFORMATION.

**PRO INSTALL TIME: 60 MIN.**  
**NOVICE INSTALL TIME: 120 MIN.**

IF YOU ARE HESITANT TO UNDERTAKE THIS TASK ON YOUR OWN, CONTACT AN AUTHORIZED CURT INSTALLER FOR ADDITIONAL ASSISTANCE.



### INSTALLATION REQUIRES:

|   |   |   |
|---|---|---|
| <br><b>13mm</b><br>SOCKET | <br>T15 TORXBIT<br>T25 SOCKETS | <br><b>6"</b><br>SOCKET<br>EXTENSION |
| <br>RATCHET              | <br>TORQUE<br>WRENCH          | <br>SCREW<br>DRIVER                  |
| <br>SAFETY<br>GLASSES   |   |   |
|   |   |   |

### INSTALLATION TIPS:

- BEFORE YOU BEGIN INSTALLATION, READ ALL INSTRUCTIONS THOROUGHLY.
- TO EASE INSTALLATION, 2 PEOPLE MAY BE REQUIRED.
- USING PROPER TOOLS WILL GREATLY IMPROVE THE QUALITY OF THE INSTALL AND REDUCE THE TIME REQUIRED.
- NEED HELP OR HAVE SOME QUESTIONS? CALL TECHNICAL SUPPORT AT 800.798.0813

### LEVEL OF DIFFICULTY: CHALLENGING

| EASY  | MODERATE   | CHALLENGING |
|---|--|-------------|
|    | NO DRILLING  |             |
|   | TEMPORARILY REMOVE BUMPER AND BUMPER COVER                 |             |
|  | TRIMMING REQUIRED ON GOLF SPORTWAGEN VEHICLES WITH 4MOTION |             |
|   |  |             |
|   |  |             |

### VEHICLE PHOTO:



REPRESENTATIVE PHOTO

### HITCH ILLUSTRATION:

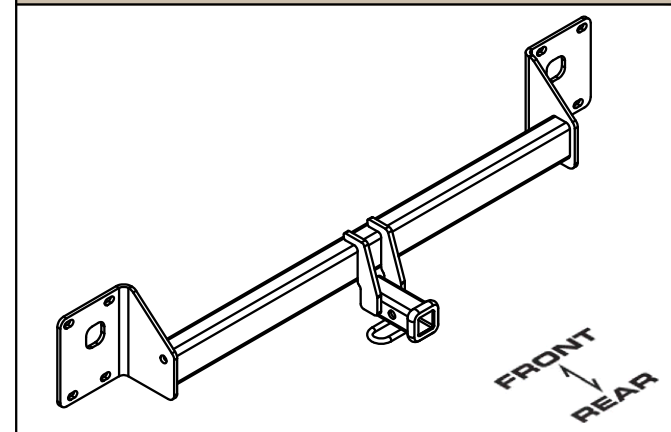

MAKE SURE YOUR HITCH MATCHES

**PERIODICALLY CHECK THIS RECEIVER HITCH TO ENSURE ALL FASTENERS ARE TIGHT AND ALL STRUCTURAL COMPONENTS ARE SOUND**

CURT Manufacturing LLC. warrants this product to be free of defects in material and/or workmanship at the time of retail purchase by the original purchaser. If the product is found to be defective, CURT Manufacturing LLC. may repair or replace the product at their option, when the product is returned, prepaid, with proof of purchase. Alteration to, misuse of, or improper installation of this product voids the warranty. CURT Manufacturing LLC.'s liability is limited to repair or replacement of products found to be defective, and specifically excludes liability for incidental or consequential loss or damage.

For more information log onto [www.curtmfg.com](http://www.curtmfg.com), & for helpful towing tips log onto [www.hitchinfo.com](http://www.hitchinfo.com)

This product complies with safety specifications and requirements for connecting devices and towing systems of the state of New York, V.E.S.C.Regulation V-5 and SAE J684.



SCAN FOR MORE INFO

# INSTALLATION WALKTHROUGH:

| Parts List |     |                |                        |
|------------|-----|----------------|------------------------|
| ITEM       | QTY | PART NUMBER    | DESCRIPTION            |
| 1          | 7   | M8-1.25 x 35   | HEX BOLT               |
| 2          | 3   | 3/8"           | CONICAL TOOTHED WASHER |
| 3          | 4   | M8 LOCK WASHER | 8mm LOCK WASHER        |
| 4          | 4   | M8 - WASHER    | WASHER                 |

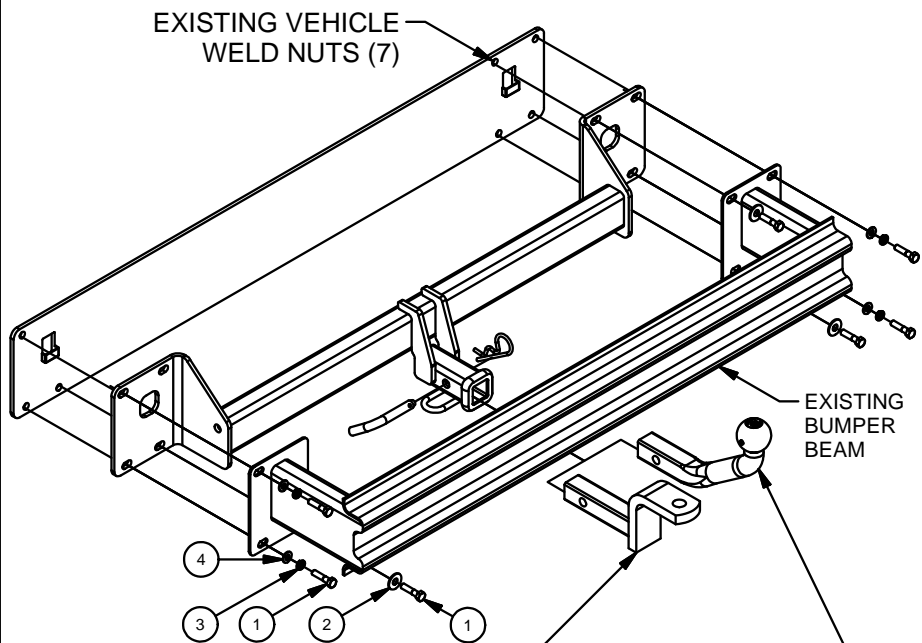

DESIGNED FOR USE WITH BALLMOUNT #45521

EURO MOUNT OPTION AVAILABLE  
#45571 (1 7/8" BALL)  
#45572 (2" BALL)

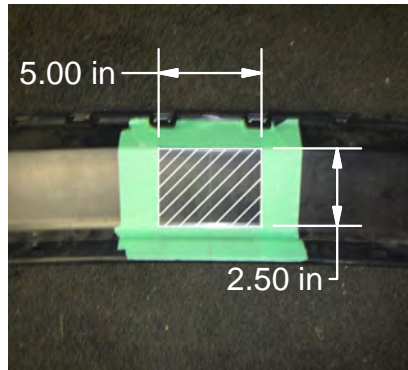

**TRIM DIAGRAM FOR  
GOLF SPORTWAGEN  
4MOTION VEHICLES**

FRONT  
↓  
REAR

1. Open the panel on the driver side of the rear cargo area inside the vehicle. Disconnect the wiring going to the tail light and then remove the plastic screw retaining the tail light. Grasp the sides of the tail light and gently pull straight to the rear of the vehicle to remove. Repeat for passenger side. Save for reinstallation.

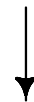
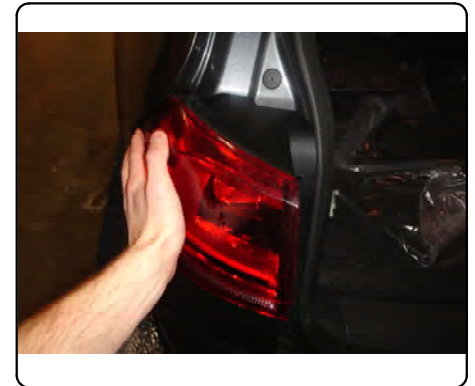
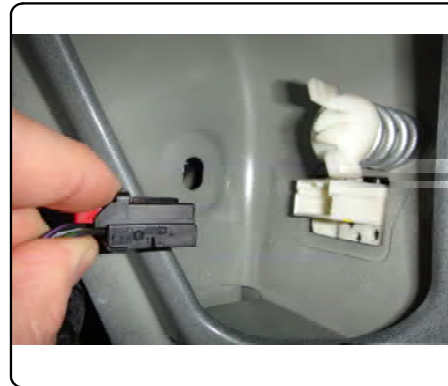

2. Remove the (4) screws from each wheel well using a T25 Torx bit and save for reinstallation.

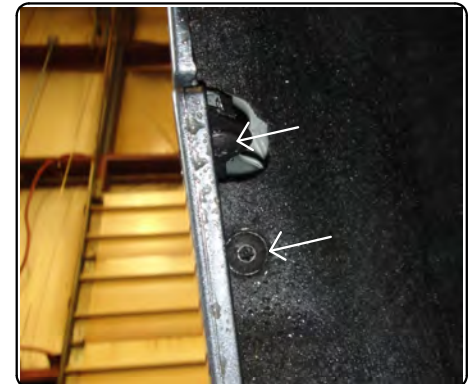
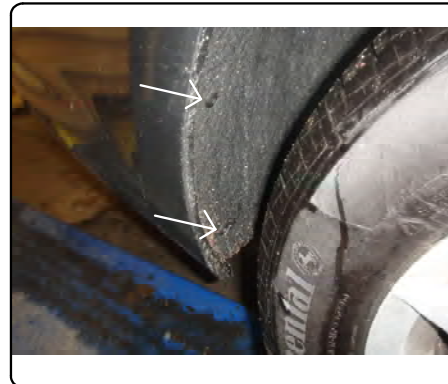

## INSTALLATION WALKTHROUGH:

3. Remove (9) screws from the bottom of the bumper cover, (5) using a T25 Torx bit and (4) using a T15 Torx bit. Remove the plastic nut that holds the smaller screws. Save for reinstallation.



4. Remove bumper cover by gently pulling the bumper cover from the location of the nuts for the bolts removed from the wheel well and the bottom of the wheel well on both sides. Gently pull the bumper cover from the wheel well area toward the rear of the vehicle on both sides. Continue pulling straight back using a flat screwdriver to detach clips retaining the bumper cover as needed. Carefully remove the lower panel from the rest of the bumper cover.



5. Remove (7) M8 bolts from the bumper beam using a 13mm socket. Remove the bumper beam from the vehicle by lifting it up and then away from the vehicle.



6. Place hitch between bumper beam and vehicle. Secure with supplied (3) M8 bolts and conical washers and (4) M8 bolts, lock washers, and washers. Torque all M8 bolts to 23 ft-lbs. Reinstall bumper cover following Steps 1-4 in reverse order. **NOTE:** For Golf Sportwagen vehicles with 4MOTION see TRIM DIAGRAM on Page 2.



## TOWING SAFETY INFORMATION

### Gross Trailer Weight / GTW

The Gross Trailer Weight is the weight of the trailer & cargo. Measure this by putting the fully loaded trailer on a vehicle scale.



### Tongue Weight / TW

The downward force that is exerted on the hitch ball by the coupler. The tongue weight will vary depending on where the load is positioned in relationship to the trailer axle(s). To measure the tongue weight, use either a commercial scale or a bathroom scale with the coupler at towing height. When using a bathroom scale with heavier tongue weights, use the method shown and multiply the scale reading by 3.

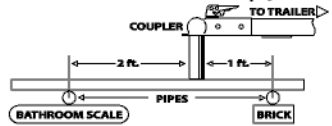

### Weight Carrying / WC

The total weight of both the trailer and the cargo inside. Never exceed the weight capacity of your trailer hitch.

### Weight Distribution / WD

Used to balance the weight of the cargo between the front and rear wheels throughout the trailer, allowing for better steering, braking, and level riding.



### Sway Control

A device used to reduce the lateral movements of the trailer that are caused by the wind. This works in conjunction with a weight distribution hitch. Do not use this on a class 1 or 2 hitch, or with surge brakes.

### How Much Can You Safely Tow?

| TONGUE WEIGHT (lb)  | 1000 | 2000 | 3000 | 4000 | 5000 | 6000 | 7000 | 8000 | 10,000 | 12,000 |
|---|------|------|------|------|------|------|------|------|--------|--------|
| Tongue weight should be about 10 to 15 percent of the gross trailer weight. |      |      |      |      |      |      |      |      |        |        |
| CLASS 1   |      |      |      |      |      |      |      |      |        |        |
| CLASS 2   |      |      |      |      |      |      |      |      |        |        |
| CLASS 3   |      |      |      |      |      |      |      |      |        |        |
| CLASS 4   |      |      |      |      |      |      |      |      |        |        |
| CLASS 5   |      |      |      |      |      |      |      |      |        |        |
| TRAILER TYPE  |      |      |      |      |      |      |      |      |        |        |
| Camper  | 11'  | 12'  | 13'  | 14'  | 15'  | 16'  |      |      |        |        |
| lbs.  | 1100 | 1200 | 1300 | 1400 | 1500 | 1600 |      |      |        |        |
| Vacation  | 18'  | 19'  | 20'  | 21'  | 22'  | 24'  | 26'  | 28'  | 30'    | 32'    |
| lbs.  | 2100 | 2400 | 2700 | 3000 | 3300 | 3600 | 3900 | 4200 | 4500   | 4800   |
| Vacation  | 18'  | 19'  | 20'  | 21'  | 22'  | 24'  | 26'  | 28'  | 30'    | 32'    |
| lbs.  | 2800 | 3200 | 3600 | 4000 | 4400 | 4800 | 5200 | 5600 | 6000   | 6400   |
| 5th Wheel   |      |      |      |      |      |      |      |      |        |        |

Refer to owner's manual for towing capabilities and limitations.

### Ball Mount

The ball mount is placed inside the opening of the receiver hitch which is mounted to the vehicle. Make sure a hitch pin and clip is properly securing the ball mount to the receiver hitch before you begin towing.

- A: Rise. B: Drop. C: Hole Size. D: Length.



### Trailer Ball

The connection from the hitch to the trailer. There are many factors that determine the correct hitch ball:

- Number one is the hitch ball's gross trailer weight rating.
- The mounting platform must be at least 3/8" thick.
- The hole diameter must not be more than 1/16" larger than the threaded shank.
- Every time you tow, check the nut and lock washer to make sure they are fastened securely.
- A: Ball Dia. B: Shank Length. C: Shank Dia. D: Shank Rise.

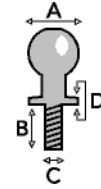

### Coupler

The component that is placed over the trailer ball to connect the vehicle to the trailer. Be sure that the coupler size matches the size of the hitch ball and that the coupler handle is securely fastened. To determine what size hitch ball you need for your application you will need to know the size of coupler that is on the trailer. Be sure your coupler is properly adjusted to the ball you are using.

NOTE: For added security the use of safety devices such as Coupler Safety Pins and Locks is strongly recommended.

### Safety Chains

Safety chains are a requirement and should be crossed under the tongue of the trailer so that the tongue will not drop to the road if it becomes separated from the hitch. Always leave enough slack so you can turn. Never allow the safety chains to drag on the ground and never attach the chains to the bumper.

Trailer Classification: Safety Chain Breaking Force - Minimum

Class 1: 2,000 lbs. (8.9 kN)

Class 2: 3,500 lbs. (15.6 kN)

Class 3: 5,000 lbs. (22.2 kN)

The strength rating of each length of safety chain or its equivalent and its attachments shall be equal to or exceed in minimum breaking force the GVWR (Gross Vehicle Weight Rating) of the trailer.

### Electrical

Trailer lights, Electric Brakes, Break-away systems - Every time you tow, be sure to check that all components are working properly.

Wiring identification by color:

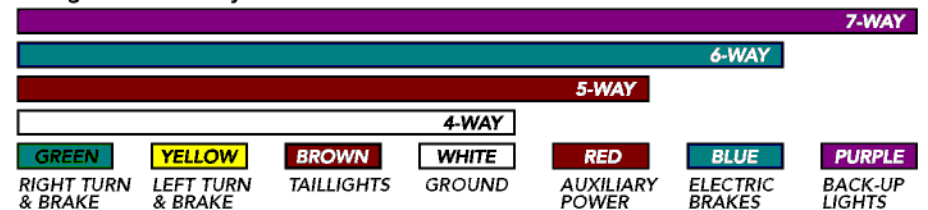

CURT DISCLAIMER: WIRING COLOR SHOWN WORK IN CONJUNCTION WITH CURT MANUFACTURING PRODUCTS.

# 11422 VOLKSWAGEN GOLF SPORTWAGEN / GOLF ALLTRACK

9/22/2017

GROSS LOAD CAPACITY WHEN USED AS A WEIGHT CARRYING HITCH: 2,000 LBS. TRAILER WEIGHT & 200 LBS. TONGUE WEIGHT.

WARNING: ALL NON-TRAILER LOADS APPLIED TO THIS PRODUCT MUST BE SUPPORTED BY 18050 STABILIZING STRAPS.

WARNING: \*\* FAILURE TO PROPERLY SUPPORT NON-TRAILER LOADS WILL VOID PRODUCT WARRANTY \*\*

WARNING: \*\*\* DO NOT EXCEED VEHICLE MANUFACTURER'S RECOMMENDED TOWING CAPACITY \*\*\*

FOR MORE INFORMATION LOG ONTO [WWW.CURTMFG.COM](http://WWW.CURTMFG.COM) & FOR HELPFUL TOWING TIPS LOG ONTO [WWW.HITCHINFO.COM](http://WWW.HITCHINFO.COM)  
HAVING INSTALLATION QUESTIONS? CALL TECHNICAL SUPPORT AT 1-800-798-0813



| Parts List |     |                |                        |
|------------|-----|----------------|------------------------|
| ITEM       | QTY | PART NUMBER    | DESCRIPTION            |
| 1          | 7   | M8-1.25 x 35   | HEX BOLT               |
| 2          | 3   | 3/8"           | CONICAL TOOTHED WASHER |
| 3          | 4   | M8 LOCK WASHER | 8mm LOCK WASHER        |
| 4          | 4   | M8 - WASHER    | WASHER                 |

EXISTING VEHICLE WELD NUTS (7)

| TOOLS REQUIRED        |
|-----------------------|
| 13mm SOCKET           |
| T15 & T25 TORX SOCKET |
| 6" SOCKET EXTENSION   |
| RATCHET               |
| TORQUE WRENCH         |
| FLAT SCREWDRIVER      |
| SAFETY GLASSES        |

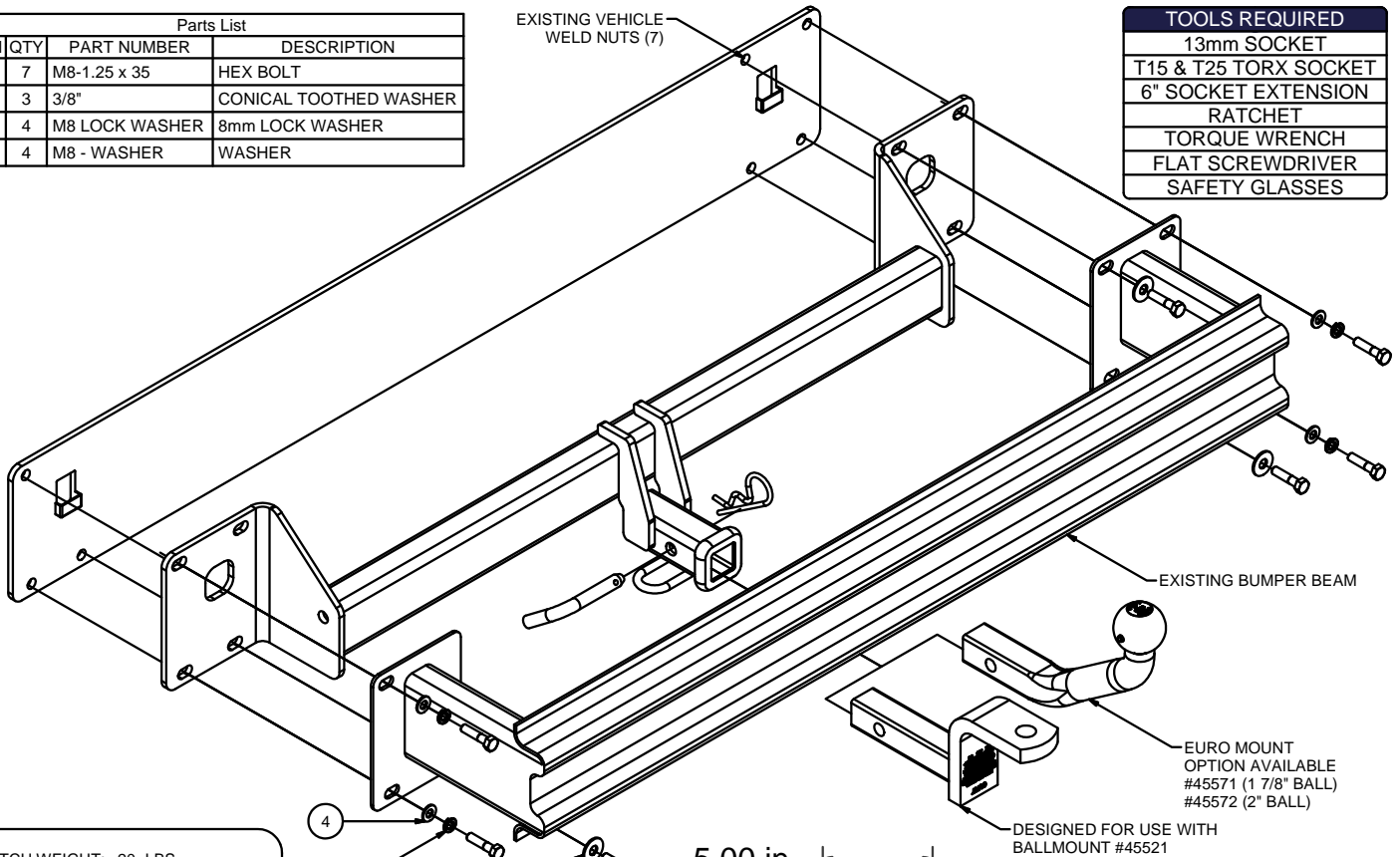

DESIGNED FOR USE WITH BALLMOUNT #45521

HITCH WEIGHT: 20 LBS.

#### INSTALL TIME

PROFESSIONAL: 60 MINUTES

NOVICE (DIY): 120 MINUTES

#### INSTALL NOTES:

- NO DRILLING
- TEMPORARILY REMOVE BUMPER AND BUMPER COVER
- TRIMMING REQUIRED ON VEHICLES WITH 4MOTION

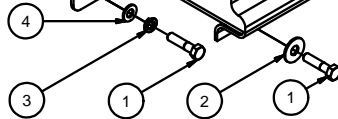

#### TRIM DIAGRAM FOR GOLF SPORTWAGEN 4MOTION VEHICLES

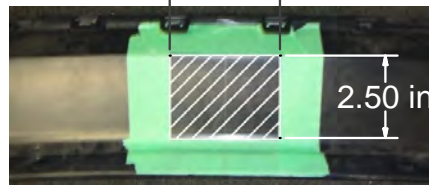

## INSTALLATION STEPS

1. Open the panel on the driver side of the rear cargo area inside the vehicle. Disconnect the wiring going to the tail light and then remove the plastic screw retaining the tail light. Grasp the sides of the tail light and gently pull straight towards the rear of the vehicle to remove. Repeat for passenger side. Save for reinstallation.
2. Remove the (4) screws from each wheel well using a T25 Torx bit and save for reinstallation.
3. Remove (9) screws from the bottom of the bumper cover, (5) using a T25 Torx bit and (4) using a T15 Torx bit. Remove the plastic nut that holds the smaller screws. Save for reinstallation.
4. Remove bumper cover by gently pulling the bumper cover from the location of the nuts for the bolts removed from the wheel well and the bottom of the wheel well on both sides. Gently pull the bumper cover from the wheel well area towards the rear of the vehicle on both sides. Continue pulling straight back using a flat screwdriver to detach clips retaining the bumper cover as needed. Carefully remove the lower panel from the rest of the bumper cover.
5. Remove (7) M8 bolts from the bumper beam using a 13mm socket. Remove the bumper beam from the vehicle by lifting it up and then away from the vehicle.
6. Place hitch between bumper beam and vehicle. Secure with supplied (3) M8 bolts and conical washers and (4) M8 bolts, lock washers, and washers. Torque all M8 bolts to 23 ft-lbs. Reinstall bumper cover following Steps 1-4 in reverse order.

**NOTE:** For Golf Sportwagen vehicles with 4MOTION see TRIM DIAGRAM above.

PERIODICALLY CHECK THIS RECEIVER HITCH TO ENSURE THAT ALL FASTENERS ARE TIGHT AND THAT ALL STRUCTURAL COMPONENTS ARE SOUND.



Scan for more information

CURT Manufacturing LLC., warrants this product to be free of defects in material and/or workmanship at the time of retail purchase by the original purchaser. If the product is found to be defective, CURT Manufacturing LLC., may repair or replace the product, at their option, when the product is returned, prepaid, with proof of purchase. Alteration to, misuse of, or improper installation of this product voids the warranty. CURT Manufacturing LLC.'s liability is limited to repair or replacement of products found to be defective, and specifically excludes liability for incidental or consequential loss or damage.

This product complies with safety specifications and requirements for connecting devices and towing systems of the state of New York, V.E.S.C.Regulation V-5 and SAE J684.