

YEARS: 2012-Present

MAKE: TOYOTA

MODEL: AVALON / CAMRY

STYLE: SEDAN

WARNING: NEVER EXCEED YOUR VEHICLE MANUFACTURER'S RECOMMENDED TOWING CAPACITY

WEIGHT CARRYING:
 TRAILER WEIGHT: 3500 LBS.
 TONGUE WEIGHT: 350 LBS.

WARNING:
 WE RECOMMEND THE USE OF 18050 STABILIZING STRAPS FOR ALL NON-TRAILER (WHEEL-LESS) LOADS. PLEASE SEE THE CURT CATALOG OR VISIT US ONLINE AT WWW.CURTMFG.COM FOR FURTHER INFORMATION.

PRO INSTALL TIME: 50 MIN.
NOVICE INSTALL TIME: 100 MIN.

IF YOU ARE HESITANT TO UNDERTAKE THIS TASK ON YOUR OWN, CONTACT AN AUTHORIZED CURT INSTALLER FOR ADDITIONAL ASSISTANCE.

INSTALLATION REQUIRES:

DIE GRINDER	POWER DRILL	DRILL BIT 1/2"
MARKER	RATCHET	AVIATION SHEARS
SAFETY GLASSES	10mm SOCKET	3/4" SOCKET
TORQUE WRENCH	TAPE MEASURE	

INSTALLATION TIPS:

- BEFORE YOU BEGIN INSTALLATION, READ ALL INSTRUCTIONS THOROUGHLY.
- TO EASE INSTALLATION, 2 PEOPLE MAY BE REQUIRED.
- USING PROPER TOOLS WILL GREATLY IMPROVE THE QUALITY OF THE INSTALL AND REDUCE THE TIME REQUIRED.
- NEED HELP OR HAVE SOME QUESTIONS? CALL TECHNICAL SUPPORT AT 800.798.0813

LEVEL OF DIFFICULTY: MODERATE

EASY	MODERATE	CHALLENGING
	Temporary lowering of exhaust required	
	Underbody panel removal required	
	Heat shield trimming required	
	Drilling required	
	Hole enlargement	

VEHICLE PHOTO:



REPRESENTATIVE PHOTO

HITCH ILLUSTRATION:

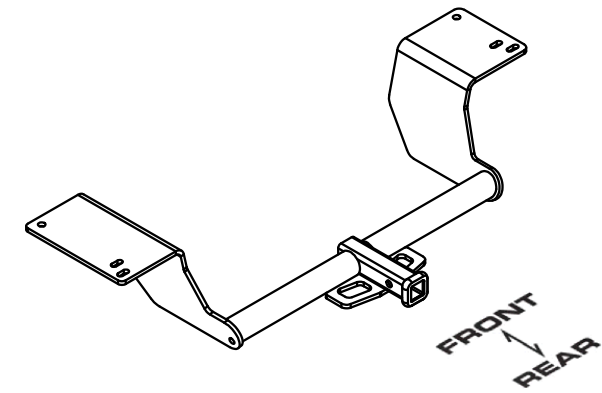

MAKE SURE YOUR HITCH MATCHES

PERIODICALLY CHECK THIS RECEIVER HITCH TO ENSURE ALL FASTENERS ARE TIGHT AND ALL STRUCTURAL COMPONENTS ARE SOUND

CURT Manufacturing LLC. warrants this product to be free of defects in material and/or workmanship at the time of retail purchase by the original purchaser. If the product is found to be defective, Curt Manufacturing LLC. may repair or replace the product at their option, when the product is returned, prepaid, with proof of purchase. Alteration to, misuse of, or improper installation of this product voids the warranty. Curt Manufacturing LLC.'s liability is limited to repair or replacement of products found to be defective, and specifically excludes liability for incidental or consequential loss or damage.

For more information log onto www.curtmfg.com, & for helpful towing tips log onto www.hitchinfo.com

INSTALLATION WALKTHROUGH:

Parts List			
ITEM	QTY	PART NUMBER	DESCRIPTION
1	4	3/8"	CONICAL TOOTHED WASHER
2	4	M10-1.25 x 35	HEX BOLT
3	2	CM-SP10	.250 x 1.00 x 2.50" SQUARE HOLE SPACER
4	2	1/2-13 x 1 1/4, GR8	CARRIAGE BOLT
5	2	HFN 1213, GR8	HEX FLANGE NUT
6	2	1_2 FISHWIRE	1/2" FISHWIRE

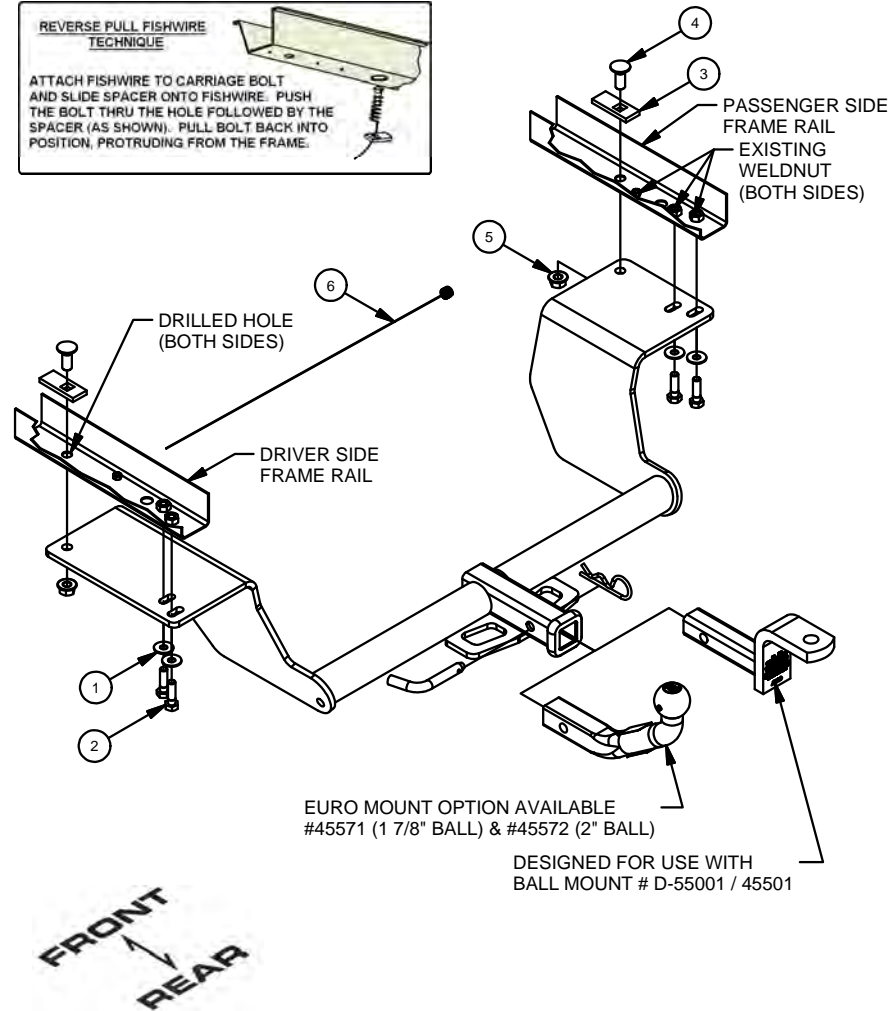
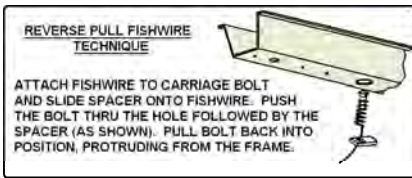

1. Remove the underbody panel if the panel covers the driver side frame, by removing the (4) screws (7 on single exhaust models) using a 10mm socket in the bumper fascia, remove the (2) push-button fasteners (4 on single exhaust models), unscrew the (3) plastic nuts using a 10mm socket towards the front of the vehicle, and unscrew the (2) plastic nuts using a 12mm socket in the center of the panel. On single exhaust models, remove (1) screw attaching the underbody cover to the driver side frame rail.

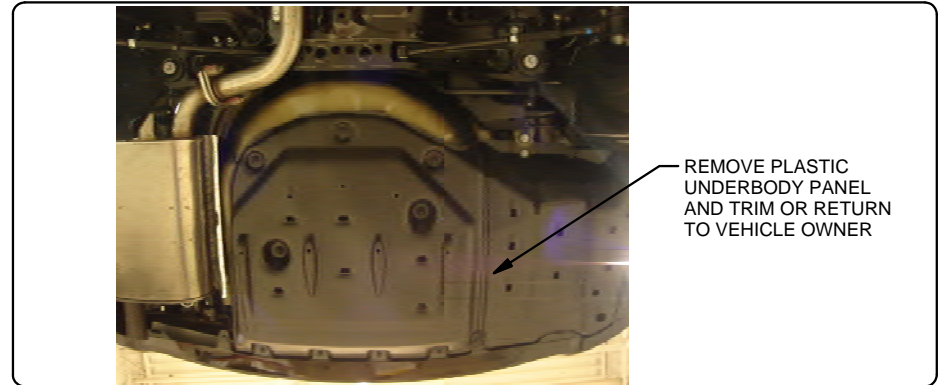

2. Lower exhaust by removing (2) bolts which attach exhaust hanger brackets to passenger side frame rail and removing rubber isolator located forward of muffler.

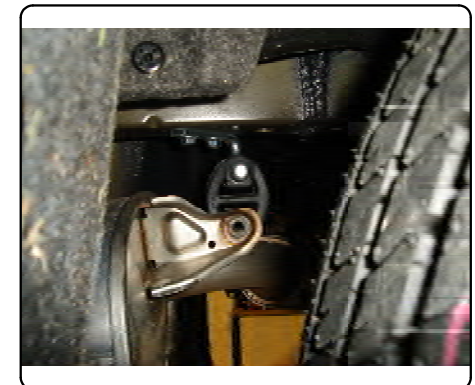
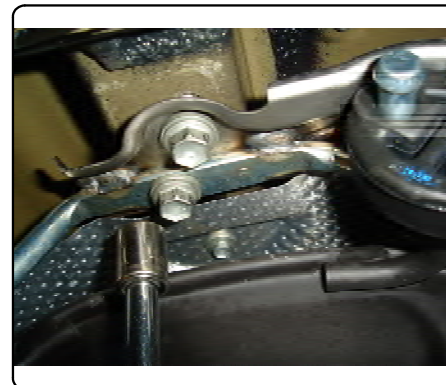

INSTALLATION WALKTHROUGH:

3. If present, remove the (2) brackets from the frame using a 14mm socket. Return brackets and fasteners to vehicle owner.

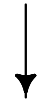

4. Remove heat shield by removing (2) screws which secure heat shield to the frame rail. Trim off rearmost section of heat shield, as shown in Heat Shield Trim Diagram below.

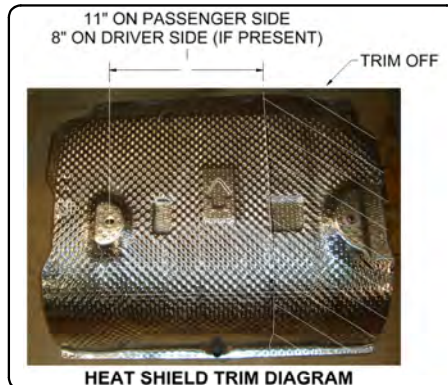
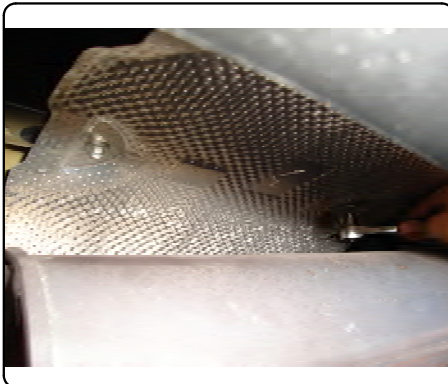

5. If vehicle is equipped with dual exhaust, repeat Steps 2 thru 4 on driver side.
6. Raise hitch into position and temporarily attach with M10 bolts in existing weldnuts in frame rails. Mark location of forward most hole in each frame rail and heat shield(s).



7. Lower hitch and drill a 1/2" pilot hole in each frame rail as marked in step 6. Make 1" hole in heat shield(s) on mark.
8. If decided to trim the underbody panel, use the diagram below. Reinstall on vehicle or return to vehicle owner.

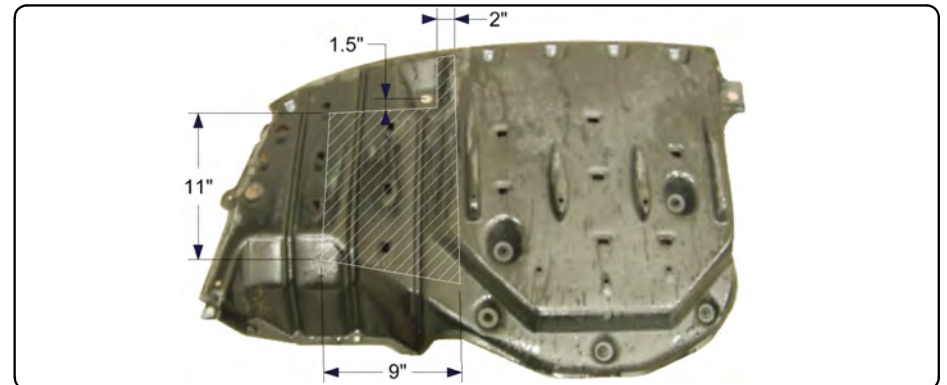

INSTALLATION WALKTHROUGH:

9. Enlarge drilled hole in each frame rail enough to accept spacers and carriage bolts, being careful not to damage weldnuts.
10. Reverse fishwire the supplied spacers and carriage bolts up through the enlarged holes drilled leaving fishwires attached. See "Reverse Fishwire Technique Diagram" (Sheet 2)

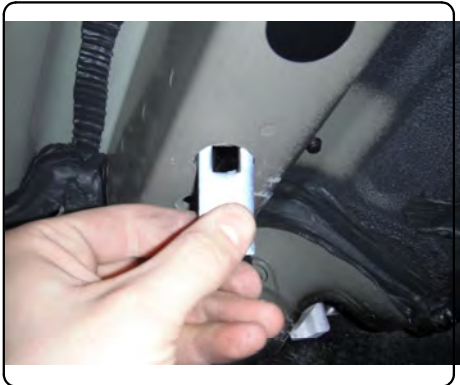

11. Bend the tab on the exhaust hanger bracket(s) so that it (they) rest flat on the surface of the side plate(s).



12. Reinstall trimmed heat shield using only forward most screw. Rearward edge of heat shield should be compressed between the frame rail and the edge of hitch side plate.

13. Raise hitch back into position, re-install exhaust hanger bracket with the hitch between it and the frame, threading the fishwires through the side plates, using the supplied fasteners. Install remaining supplied fasteners.

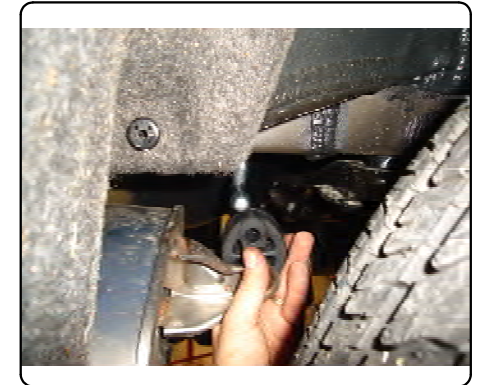

14. Torque all M10 fasteners to 45 lb.-ft. Torque all 1/2 fasteners to 110 lb.-ft.

15. Raise exhaust back into position and re-install rubber isolators if removed.



TOWING SAFETY INFORMATION

Gross Trailer Weight / GTW

The Gross Trailer Weight is the weight of the trailer & cargo. Measure this by putting the fully loaded trailer on a vehicle scale.

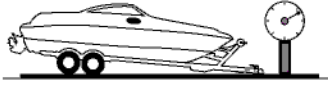

Tongue Weight / TW

The downward force that is exerted on the hitch ball by the coupler. The tongue weight will vary depending on where the load is positioned in relationship to the trailer axle(s). To measure the tongue weight, use either a commercial scale or a bathroom scale with the coupler at towing height. When using a bathroom scale with heavier tongue weights, use the method shown and multiply the scale reading by 3.

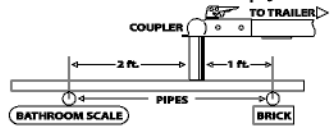

Weight Carrying / WC

The total weight of both the trailer and the cargo inside. Never exceed the weight capacity of your trailer hitch.

Weight Distribution / WD

Used to balance the weight of the cargo between the front and rear wheels throughout the trailer, allowing for better steering, braking, and level riding.



Sway Control

A device used to reduce the lateral movements of the trailer that are caused by the wind. This works in conjunction with a weight distribution hitch. Do not use this on a class 1 or 2 hitch, or with surge brakes.

How Much Can You Safely Tow?

TONGUE WEIGHT (lb)	1000	2000	3000	4000	5000	6000	7000	8000	10,000	12,000
Tongue weight should be about 10 to 15 percent of the gross trailer weight.										
CLASS 1										
CLASS 2										
CLASS 3										
CLASS 4										
CLASS 5										
TRAILER TYPE										
Camper	11'	12'	13'	14'	15'	16'				
lbs.	1100	1200	1300	1400	1500	1600				
Vacation	18'	19'	20'	22'	24'	26'	28'	30'	32'	
lbs.	2100	2400	2700	3000	3300	3600	3900	4200	4500	4800
Vacation	18'	19'	20'	22'	24'	26'	28'	30'	32'	
lbs.	2800	3200	3600	4000	4400	4800	5200	5600	6000	6400
5th Wheel										

Refer to owner's manual for towing capabilities and limitations.

Ball Mount

The ball mount is placed inside the opening of the receiver hitch which is mounted to the vehicle. Make sure a hitch pin and clip is properly securing the ball mount to the receiver hitch before you begin towing.

- A: Rise. B: Drop. C: Hole Size. D: Length.

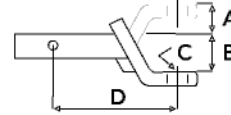

Trailer Ball

The connection from the hitch to the trailer. There are many factors that determine the correct hitch ball:

- Number one is the hitch ball's gross trailer weight rating.
- The mounting platform must be at least 3/8" thick.
- The hole diameter must not be more than 1/16" larger than the threaded shank.
- Every time you tow, check the nut and lock washer to make sure they are fastened securely.
- A: Ball Dia. B: Shank Length. C: Shank Dia. D: Shank Rise.

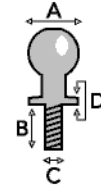

Coupler

The component that is placed over the trailer ball to connect the vehicle to the trailer. Be sure that the coupler size matches the size of the hitch ball and that the coupler handle is securely fastened. To determine what size hitch ball you need for your application you will need to know the size of coupler that is on the trailer. Be sure your coupler is properly adjusted to the ball you are using.

NOTE: For added security the use of safety devices such as Coupler Safety Pins and Locks is strongly recommended.

Safety Chains

Safety chains are a requirement and should be crossed under the tongue of the trailer so that the tongue will not drop to the road if it becomes separated from the hitch. Always leave enough slack so you can turn. Never allow the safety chains to drag on the ground and never attach the chains to the bumper.

Trailer Classification: Safety Chain Breaking Force - Minimum

Class 1: 2,000 lbs. (8.9 kN)

Class 2: 3,500 lbs. (15.6 kN)

Class 3: 5,000 lbs. (22.2 kN)

The strength rating of each length of safety chain or its equivalent and its attachments shall be equal to or exceed in minimum breaking force the GVWR (Gross Vehicle Weight Rating) of the trailer.

Electrical

Trailer lights, Electric Brakes, Break-away systems - Every time you tow, be sure to check that all components are working properly.

Wiring identification by color:



CURT DISCLAIMER: WIRING COLOR SHOWN WORK IN CONJUNCTION WITH CURT MANUFACTURING PRODUCTS.

GROSS LOAD CAPACITY WHEN USED AS A WEIGHT CARRYING HITCH: 3500 LBS. TRAILER WEIGHT & 350 LBS. TONGUE WEIGHT.

DO NOT EXCEED VEHICLE MANUFACTURER'S RECOMMENDED TOWING CAPACITY.

WARNING: ALL NON-TRAILER LOADS APPLIED TO THIS PRODUCT MUST BE SUPPORTED BY 18050 STABILIZING STRAPS.

** FAILURE TO PROPERLY SUPPORT NON-TRAILER LOADS WILL VOID PRODUCT WARRANTY**

HAVING INSTALLATION QUESTIONS? CALL TECHNICAL SUPPORT AT 1-800-798-0813

Parts List			
ITEM	QTY	PART NUMBER	DESCRIPTION
1	4	3/8"	CONICAL TOOTHED WASHER
2	4	M10-1.25 x 35	HEX BOLT
3	2	CM-SP10	.250 x 1.00 x 2.50" SQUARE HOLE SPACER
4	2	1/2-13 x 1 1/4, GR8	CARRIAGE BOLT
5	2	HFN 1213, GR8	HEX FLANGE NUT
6	2	1_2 FISHWIRE	1/2" FISHWIRE

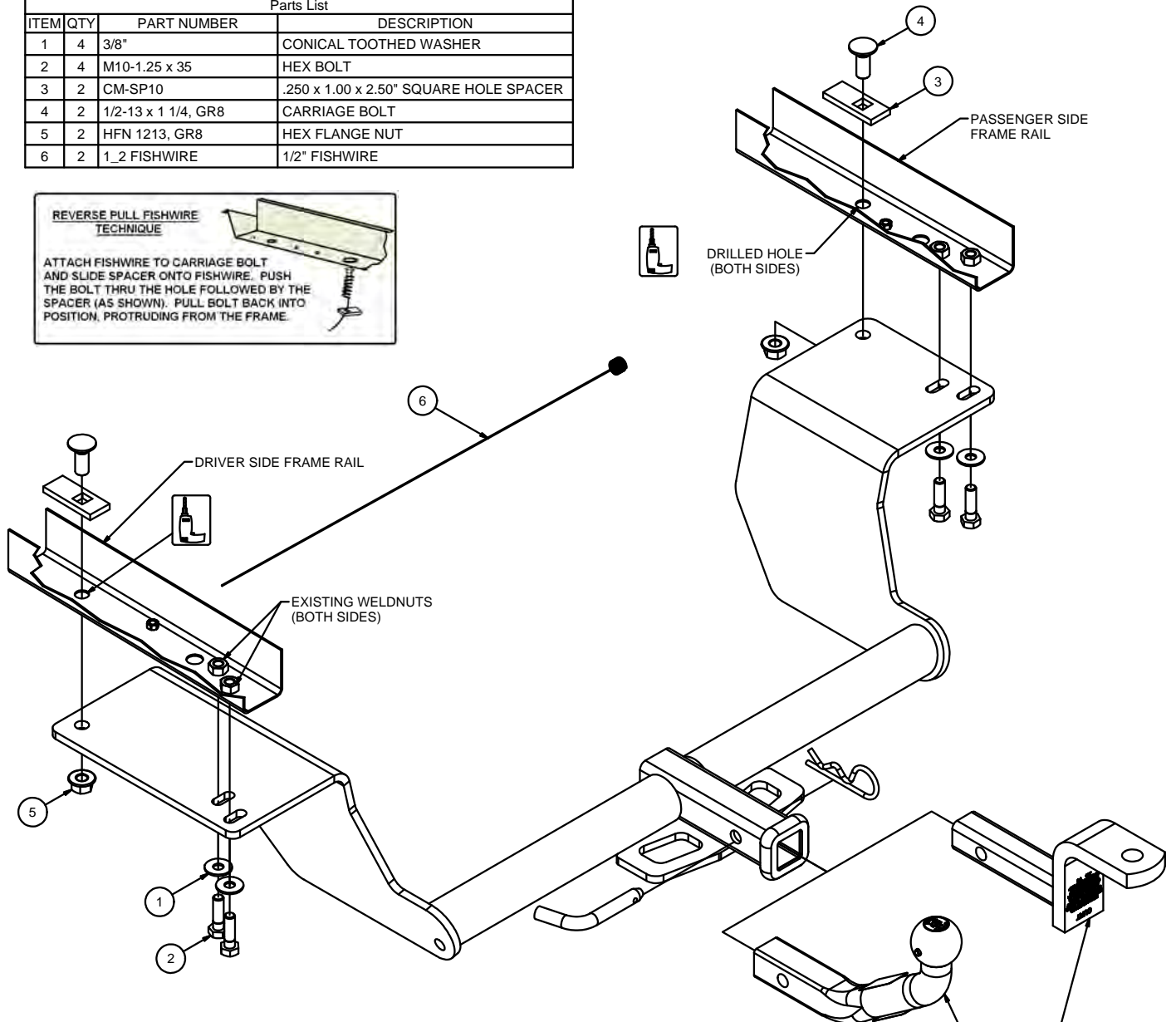
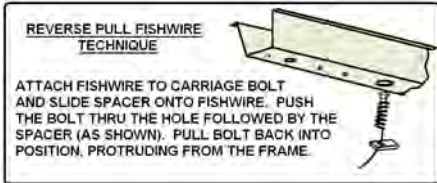

EURO MOUNT OPTION AVAILABLE
#45571 (1 7/8" BALL) & #45572 (2" BALL)

DESIGNED FOR USE WITH
BALL MOUNT # D-55001 / 45501

HITCH WEIGHT: 25 LBS.

INSTALL TIME

PROFESSIONAL: 50 MINUTES

NOVICE (DIY): 100 MINUTES

INSTALL NOTES:

- Drilling required
- Heat shield trimming required
- Temporary lowering of exhaust required
- Underbody panel removal required
- Hole enlargement required

TOOLS REQUIRED

RATCHET
TORQUE WRENCH
10mm, 12mm, 14mm SOCKETS
17mm, 3/4" SOCKETS
DRILL & 1/2" BIT
DIE GRINDER
AVIATION SHEARS
TAPE MEASURE

PERIODICALLY CHECK THIS RECEIVER HITCH TO ENSURE THAT ALL FASTENERS ARE TIGHT AND THAT ALL STRUCTURAL COMPONENTS ARE SOUND.

Curt Manufacturing LLC., warrants this product to be free of defects in material and/or workmanship at the time of retail purchase by the original purchaser. If the product is found to be defective, Curt Manufacturing LLC., may repair or replace the product, at their option, when the product is returned, prepaid, with proof of purchase. Alteration to, misuse of, or improper installation of this product voids the warranty. Curt Manufacturing LLC.'s liability is limited to repair or replacement of products found to be defective, and specifically excludes liability for incidental or consequential loss or damage.

HAVING INSTALLATION QUESTIONS? CALL TECHNICAL SUPPORT AT 1-800-798-0813

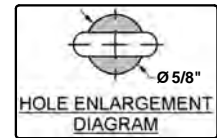
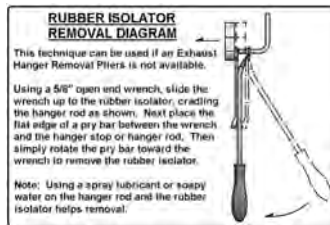

UNDERBODY PANEL TRIM DIAGRAM

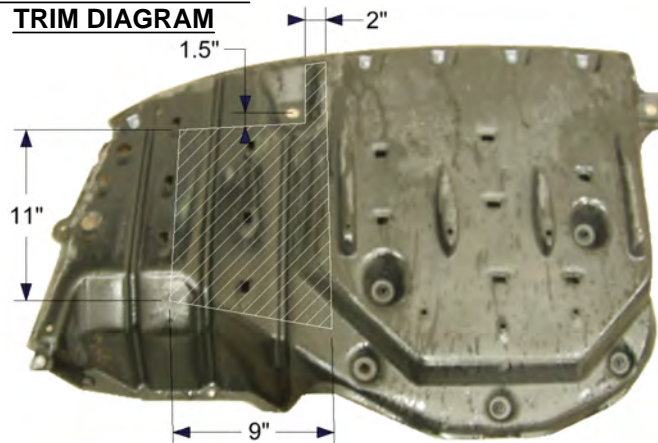

11" ON PASSENGER SIDE
8" ON DRIVER SIDE (IF PRESENT)

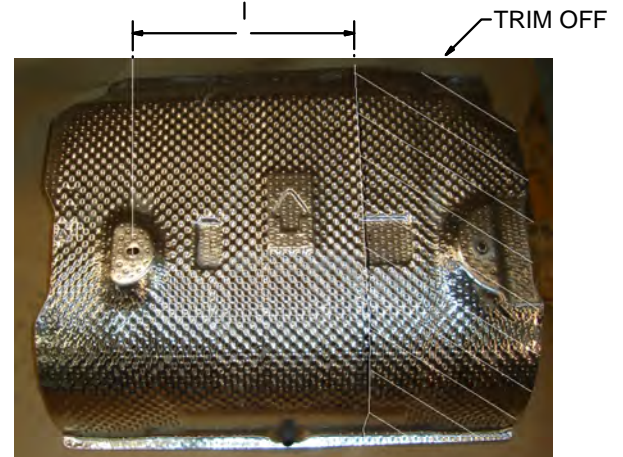

HEAT SHIELD TRIM DIAGRAM

INSTALLATION STEPS

1. Remove the underbody panel if the panel covers the driver side frame, by removing the (4) screws (7 on single exhaust models) using a 10mm socket in the bumper fascia, remove the (2) push-button fasteners (4 on single exhaust models), unscrew the (3) plastic nuts using a 10mm socket towards the front of the vehicle, and unscrew the (2) plastic nuts using a 12mm socket in the center of the panel. On single exhaust models, remove (1) screw attaching the underbody cover to the driver side frame rail.
2. Lower exhaust by removing (2) bolts which attach exhaust hanger brackets to passenger side frame rail and removing rubber isolator located forward of muffler.
3. Remove the (2) brackets from the frame using a 14mm socket. Return brackets and fasteners to vehicle owner.
4. Remove heat shield by removing (2) screws which secure heat shield to the frame rail. Trim off rearmost section of heat shield, as shown in Heat Shield Trim Diagram above.
5. If vehicle is equipped with dual exhaust, repeat Steps 2 thru 4 on driver side.
6. Raise hitch into position and temporarily attach with M10 bolts in existing weldnuts in frame rails. Mark location of forward most hole in each frame rail and heat shield(s).
7. Lower hitch and drill a 1/2" pilot hole in each frame rail as marked in step 6. Make 1" hole in heat shield(s) on mark.
8. If decided, trim the underbody panel, as shown in the diagram above, for hitch to pass through. Reinstall on vehicle or return to vehicle owner.
9. Enlarge drilled hole in each frame rail enough to accept spacers and carriage bolts, being careful not to damage weldnuts.
10. Reverse fishwire the supplied spacers and carriage bolts up through the enlarged holes drilled leaving fishwires attached. See "Reverse Fishwire Technique Diagram" (sheet 1).
11. Bend the tab on exhaust hanger bracket(s) so that the it(they) rest flat on the surface of the side plate(s).
12. Reinstall trimmed heat shield using only forward most screw. Rearward edge of heat shield should compressed be between the frame rail and the edge of hitch side plate.
13. Raise hitch back into position, re-install exhaust hanger bracket with the hitch between it and the frame, threading the fishwires through the side plates, using the supplied fasteners. Install remaining supplied fasteners.
14. Torque all M10 fasteners to 45 lb.-ft. Torque all 1/2 fasteners to 110 lb.-ft.
15. Raise exhaust back into position and re-install rubber isolators if removed.

PERIODICALLY CHECK THIS RECEIVER HITCH TO ENSURE THAT ALL FASTENERS ARE TIGHT AND THAT ALL STRUCTURAL COMPONENTS ARE SOUND.