

**13079****MITSUBISHI OUTLANDER SPORT****9/24/2012****GROSS LOAD CAPACITY WHEN USED AS A WEIGHT CARRYING HITCH: 3,500 LBS. TRAILER WEIGHT & 350 LBS. TONGUE WEIGHT.****\*\*\*DO NOT EXCEED VEHICLE MANUFACTURER'S RECOMMENDED TOWING CAPACITY.\*\*\*****WARNING: ALL NON-TRAILER LOADS APPLIED TO THIS PRODUCT MUST BE SUPPORTED BY 18050 STABILIZING STRAPS.****\*\* FAILURE TO PROPERLY SUPPORT NON-TRAILER LOADS WILL VOID PRODUCT WARRANTY\*\*****HAVING INSTALLATION QUESTIONS? CALL TECHNICAL SUPPORT AT 1-800-798-0813**

## Parts List

ITEM	QTY	PART NUMBER	DESCRIPTION
1	2	M10 - 1.25 x 25	HEX BOLT
2	2	3/8"	CONICAL TOOTHED WASHER
3	4	HFN 1213	HEX FLANGE NUT
4	4	1/2-13 x 4 1/2	CARRIAGE BOLT
5	2	CM-13079-SP	.250" SPACER PLATE

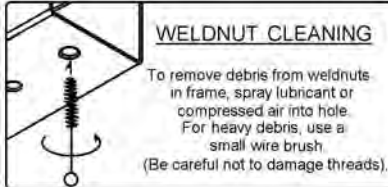

## TOOLS REQUIRED

TORQUE WRENCH
RATCHET
14mm SOCKET
17mm SOCKET
3/4" SOCKET
6" EXTENSION

FRONT  
↓  
REAR

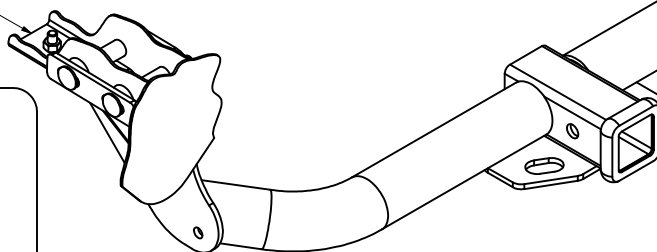
DRIVER SIDE  
FRAME RAIL

HITCH WEIGHT: 29 LBS.

## INSTALL TIME

PROFESSIONAL: 15 MINUTES

NOVICE (DIY): 30 MINUTES

## INSTALL NOTES:

- NO DRILLING REQUIRED
- TOW LOOP REMOVAL

**INSTALLATION STEPS**

1. Remove (3) bolts and tow loop from the passenger side frame rail. Return bolts and tow loop to owner.
2. Insert 1/2-13 X 4 1/2" carriage bolts and CM-12048-SP spacers through the existing holes in the side of the frame rails, as shown. After bolts are inserted push them back so the end is flush with the inside of the frame rails. **Note:** On the driver side reach between the bumper cover and rear wheel well to access the holes in the side of the frame rail.
3. Raise the hitch into position and slide the bolts in the side of the frame rails through the holes in the hitch. Loosely secure hitch with 1/2" hex flange nuts. **Note:** The carriage bolts should sit flat on the spacers. **Note:** For ease of installation raise the driver side into position first, then raise the passenger side.
4. Align the bottom tabs of the hitch with the weldnuts in the frame rails and secure with M10-1.25 x 25mm bolts and 3/8" conical toothed washers.
5. Torque all 10mm hardware to 48 ft-lbs.  
Torque all 1/2" hardware to 110 ft-lbs.

**PERIODICALLY CHECK THIS RECEIVER HITCH TO ENSURE THAT ALL FASTENERS ARE TIGHT AND THAT ALL STRUCTURAL COMPONENTS ARE SOUND.**

Curt Manufacturing Inc., warrants this product to be free of defects in material and/or workmanship at the time of retail purchase by the original purchaser. If the product is found to be defective, Curt Manufacturing Inc., may repair or replace the product, at their option, when the product is returned, prepaid, with proof of purchase. Alteration to, misuse of, or improper installation of this product voids the warranty. Curt Manufacturing Inc.'s liability is limited to repair or replacement of products found to be defective, and specifically excludes liability for incidental or consequential loss or damage.

YEARS: 2011

MAKE: MITSUBISHI

MODEL: OUTLANDER SPORT

STYLE: CROSSOVER

**WARNING: NEVER EXCEED YOUR VEHICLE MANUFACTURER'S RECOMMENDED TOWING CAPACITY**





**WEIGHT CARRYING:**  
 TRAILER WEIGHT: 3,500 LBS.  
 TONGUE WEIGHT: 350 LBS.

**WARNING:**  
 WE RECOMMEND THE USE OF 18050 STABILIZING STRAPS FOR ALL NON-TRAILER (WHEEL-LESS) LOADS. PLEASE SEE THE CURT CATALOG OR VISIT US ONLINE AT [WWW.CURTMFG.COM](http://WWW.CURTMFG.COM) FOR FURTHER INFORMATION.

**INSTALLATION TIME: 15 MIN.**

THE INSTALL TIME LISTED IS FOR PROFESSIONAL INSTALLERS. IF YOU ARE HESITANT TO UNDERTAKE THIS TASK ON YOUR OWN, CONTACT AN AUTHORIZED CURT INSTALLER FOR ADDITIONAL ASSISTANCE.

**INSTALLATION REQUIRES:**

 <b>TORQUE WRENCH</b>	 <b>RATCHET</b>	 <b>14mm 17mm 3/4"</b>
 <b>6" SOCKET EXTENSION</b>		

**INSTALLATION TIPS:**

- BEFORE YOU BEGIN INSTALLATION, READ ALL INSTRUCTIONS THOROUGHLY.
- TO EASE INSTALLATION, 2 PEOPLE MAY BE REQUIRED.
- USING PROPER TOOLS WILL GREATLY IMPROVE THE QUALITY OF THE INSTALL AND REDUCE THE TIME REQUIRED.
- NEED HELP OR HAVE SOME QUESTIONS? CALL TECHNICAL SUPPORT AT 800.798.0813

**LEVEL OF DIFFICULTY: EASY**

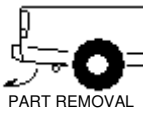
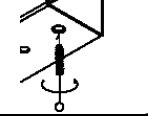
<b>EASY</b>	<b>MODERATE</b>	<b>HARD</b>
	- NO DRILLING REQUIRED	
	- TOW LOOP REMOVAL	
	- MAY NEED WELDNUT CLEANING	

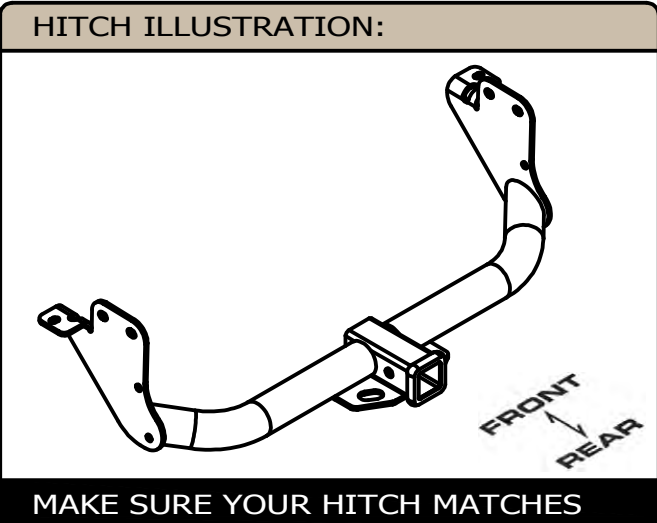
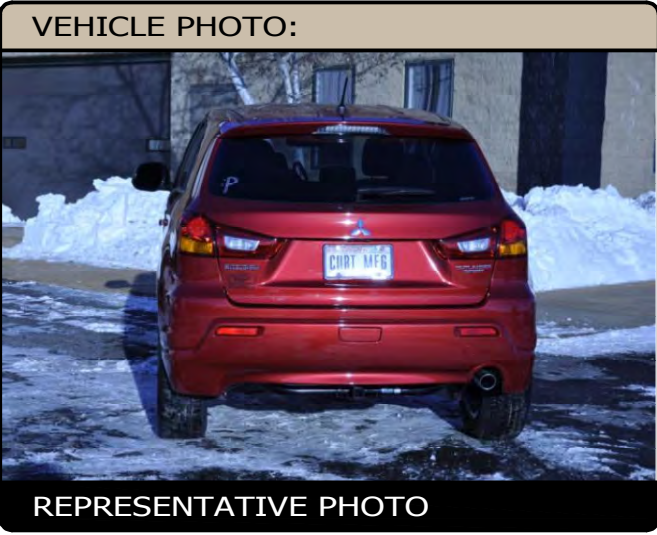

**PERIODICALLY CHECK THIS RECEIVER HITCH TO ENSURE ALL FASTENERS ARE TIGHT AND ALL STRUCTURAL COMPONENTS ARE SOUND**

CURT Manufacturing Inc. warrants this product to be free of defects in material and/or workmanship at the time of retail purchase by the original purchaser. If the product is found to be defective, Curt Manufacturing Inc. may repair or replace the product at their option, when the product is returned, prepaid, with proof of purchase. Alteration to, misuse of, or improper installation of this product voids the warranty. Curt Manufacturing Inc.'s liability is limited to repair or replacement of products found to be defective, and specifically excludes liability for incidental or consequential loss or damage.

For more information log onto [www.curtmfg.com](http://www.curtmfg.com), & for helpful towing tips log onto [www.hitchinfo.com](http://www.hitchinfo.com)

## INSTALLATION WALKTHROUGH:

Parts List			
ITEM	QTY	PART NUMBER	DESCRIPTION
1	2	M10 - 1.25 x 25	HEX BOLT
2	2	3/8"	CONICAL TOOTHED WASHER
3	4	HFN 1213	HEX FLANGE NUT
4	4	1/2-13 x 4 1/2	CARRIAGE BOLT
5	2	CM-13079-SP	.250" SPACER PLATE

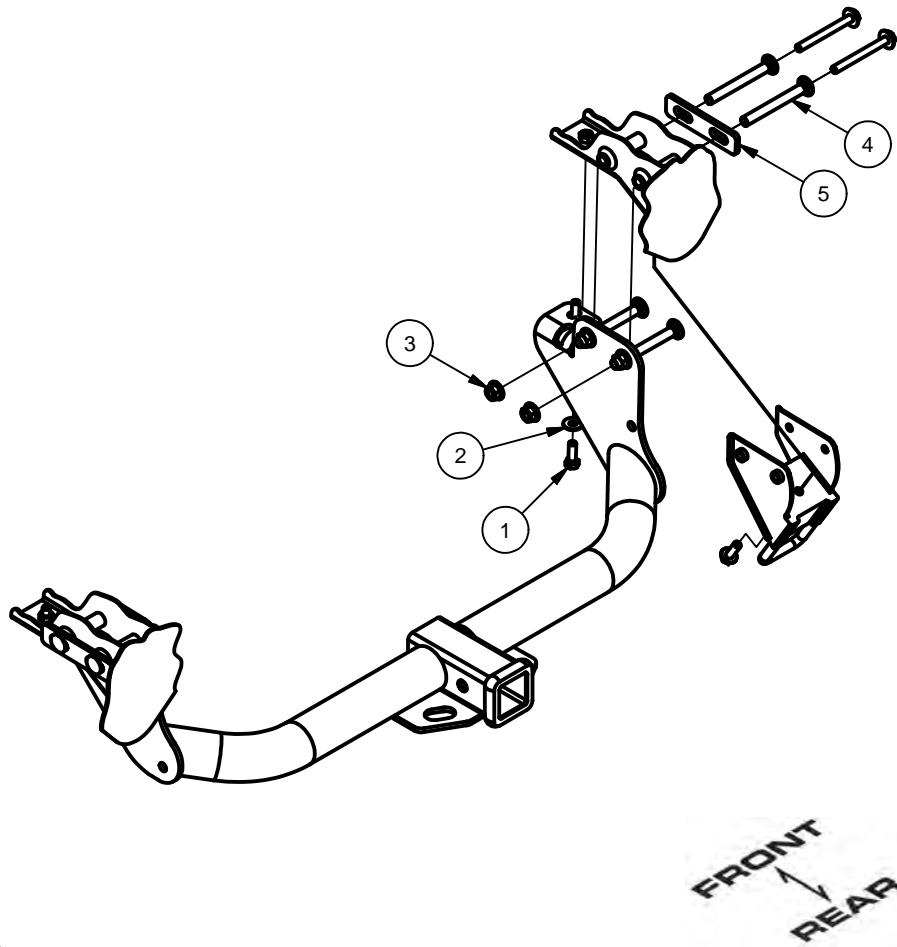

1. Remove (3) bolts and tow loop from the passenger side frame rail. Return bolts and tow loop to owner



2. Insert 1/2-13 x 4 1/2" carriage bolts and CM-12048-SP spacers through the existing holes in the side of the frame rails. After bolts are inserted push them back so the end is flush with the inside of the frame rails. **Note:** On the driver side, reach between the bumper cover and rear wheel well to access the holes in the side of the frame rail.

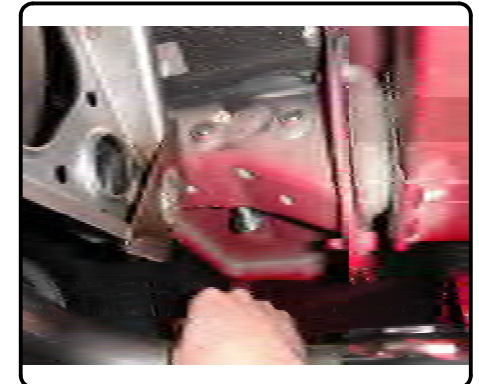

## INSTALLATION WALKTHROUGH:

3. Raise the hitch into position and slide the bolts in the side of the frame rails through the holes in the hitch. Loosely secure hitch with 1/2" hex flange nuts. **Note:** The carriage bolts should sit flat on the spacers. **Note:** For ease of installation raise the driver side into position first, then raise the passenger side

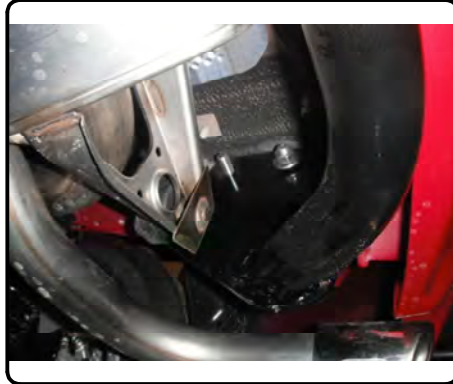
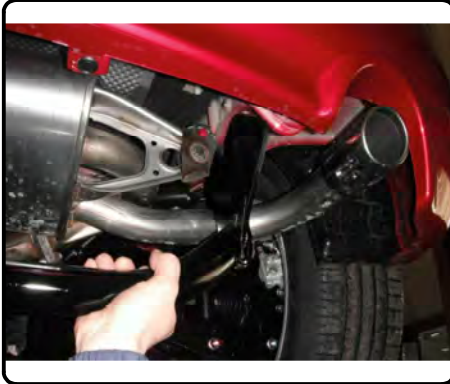

4. Align the bottom tabs of the hitch with the weldnuts in the frame rails and secure with M10-1.25 x 25mm bolts and 3/8" conical toothed washers.

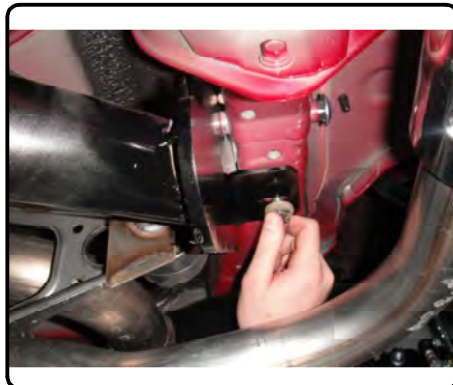
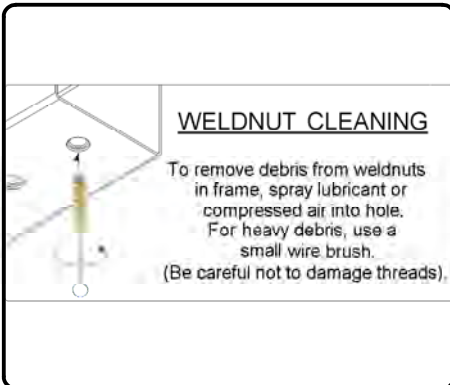

5. Torque all 10mm hardware to 48 ft-lbs. Torque all 1/2" hardware to 110 ft-lbs.



**Install is complete.**

