



Safety glasses should be worn at all times while installing this product.

YEARS: 2014-PRESENT

MAKE: JEEP

MODEL: CHEROKEE

STYLE: ALL (INCLUDES TRAILHAWK)

WARNING: NEVER EXCEED YOUR VEHICLE MANUFACTURER'S RECOMMENDED TOWING CAPACITY





WEIGHT CARRYING:
 TRAILER WEIGHT: 5000 LBS.
 TONGUE WEIGHT: 750 LBS.

WEIGHT DISTRIBUTION:
 TRAILER WEIGHT: 6000 LBS.
 TONGUE WEIGHT: 750 LBS.

PRO INSTALL TIME: 30 MIN.
NOVICE INSTALL TIME: 60 MIN.

IF YOU ARE HESITANT TO UNDERTAKE THIS TASK ON YOUR OWN, CONTACT AN AUTHORIZED CURT INSTALLER FOR ADDITIONAL ASSISTANCE.



INSTALLATION REQUIRES:

 SAFETY GLASSES	 RATCHET	 3/4" 8mm 21mm SOCKET
 6" SOCKET EXTENSION	 TORQUE WRENCH	

INSTALLATION TIPS:

- BEFORE YOU BEGIN INSTALLATION, READ ALL INSTRUCTIONS THOROUGHLY.
- TO EASE INSTALLATION, 2 PEOPLE MAY BE REQUIRED.
- USING PROPER TOOLS WILL GREATLY IMPROVE THE QUALITY OF THE INSTALL AND REDUCE THE TIME REQUIRED.
- NEED HELP OR HAVE SOME QUESTIONS? CALL TECHNICAL SUPPORT AT 800.798.0813

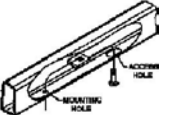
LEVEL OF DIFFICULTY: EASY

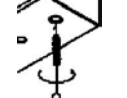
EASY	MODERATE	CHALLENGING
	NO DRILLING REQUIRED	
	FISHWIRE HARDWARE	
	REVERSE FISHWIRE HARDWARE	
	TRAILHAWK MODELS: CLEAN WELDNUTS IF NEEDED	
	TRAILHAWK MODELS: TEMPORARILY REMOVE PLASTIC FASCIA	

VEHICLE PHOTO:



REPRESENTATIVE PHOTO

HITCH ILLUSTRATION:

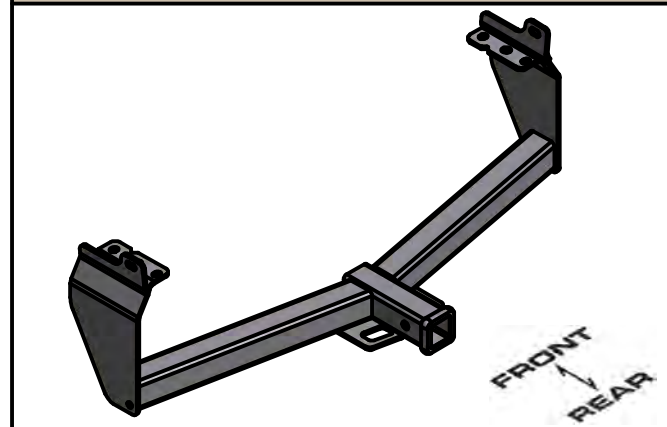

MAKE SURE YOUR HITCH MATCHES



SCAN FOR MORE INFO

PERIODICALLY CHECK THIS RECEIVER HITCH TO ENSURE ALL FASTENERS ARE TIGHT AND ALL STRUCTURAL COMPONENTS ARE SOUND CURT Manufacturing LLC. warrants this product to be free of defects in material and/or workmanship at the time of retail purchase by the original purchaser. If the product is found to be defective, Curt Manufacturing LLC. may repair or replace the product at their option, when the product is returned, prepaid, with proof of purchase. Alteration to, misuse of, or improper installation of this product voids the warranty. Curt Manufacturing LLC.'s liability is limited to repair or replacement of products found to be defective, and specifically excludes liability for incidental or consequential loss or damage. For more information log onto www.curtmfg.com, & for helpful towing tips log onto www.hitchinfo.com

INSTALLATION WALKTHROUGH:

Parts List			
ITEM	QTY	PART NUMBER	DESCRIPTION
1	6	HFN 1213, GR8	HEX FLANGE NUT
2	6	1/2-13 x 1 1/2, GR8	CARRIAGE BOLT
3	6	1_2 FISHWIRE	1/2" FISHWIRE
4	6	CM-SP6	.250 x 1.00 x 3.00" SQUARE HOLE SPACER

FISHWIRE TECHNIQUE
 INSERT COILED END OF FISHWIRE TOOL THROUGH HITCH MOUNTING HOLE IN VEHICLE FRAME RAIL AND OUT THE ACCESS HOLE. PASS COILED END OF FISHWIRE THROUGH SPACER AND THREAD BOLT INTO COIL. KINK WIRE TO KEEP SPACER SEPERATE FROM BOLT AS SHOWN. PULL FISHWIRE, SPACER, AND BOLT THROUGH FRAME AND OUT MOUNTING HOLE. USE FISHWIRE TO GUIDE HITCH DURING MOUNTING AND PREVENT LOSS OF BOLT / SPACER INSIDE FRAME RAIL.
NOTE: SOME VEHICLES MAY FISHWIRE THROUGH END OF FRAME

REVERSE PULL FISHWIRE TECHNIQUE
 ATTACH FISHWIRE TO CARRIAGE BOLT AND SLIDE SPACER ONTO FISHWIRE. PUSH THE BOLT THRU THE HOLE FOLLOWED BY THE SPACER (AS SHOWN). PULL BOLT BACK INTO POSITION, PROTRUDING FROM THE FRAME.

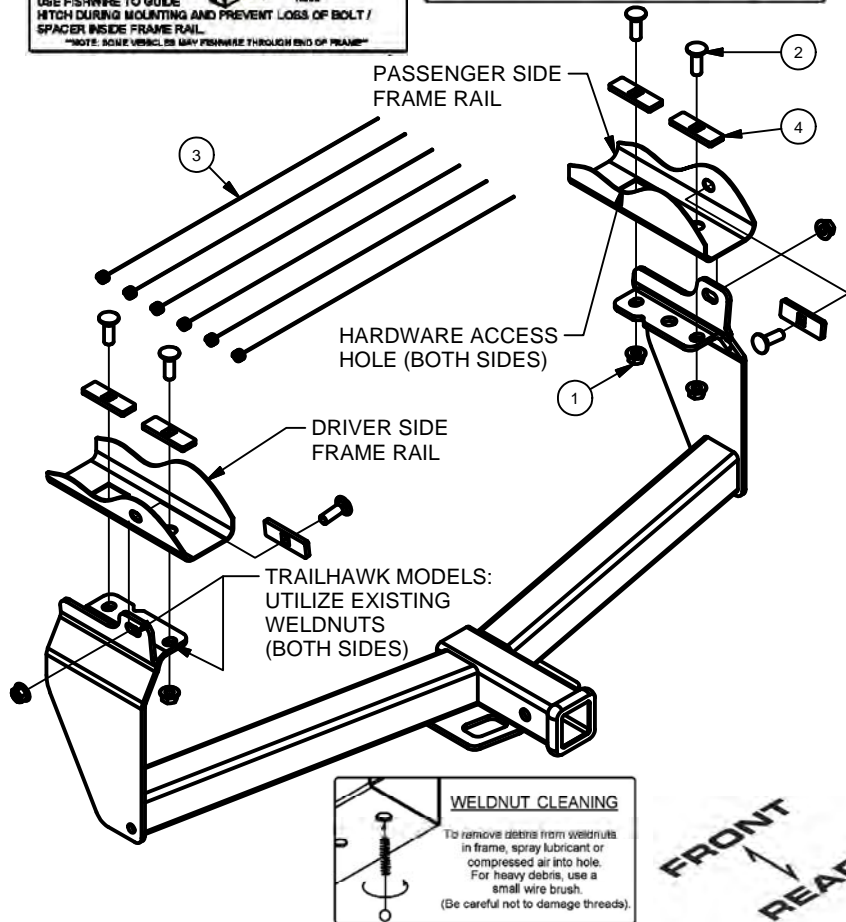

1. Trailhawk models: Temporary plastic fascia removal is required for install. Remove (4) screws with a 10mm socket from the bottom of the panel, and push on tabs to unclip. Set aside for reassembly.

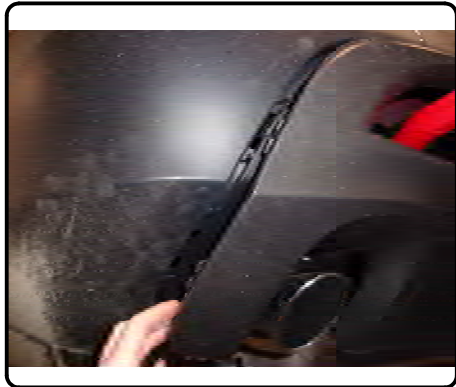

2. Examine vehicle frame rails - If wire is present on either side frame rail, unfasten by pulling retainer out of the frame and temporary let hang loose below frame rail.
 Remove square rubber plug on each side of the frame rail to expose hardware access holes. Return plugs to owner.

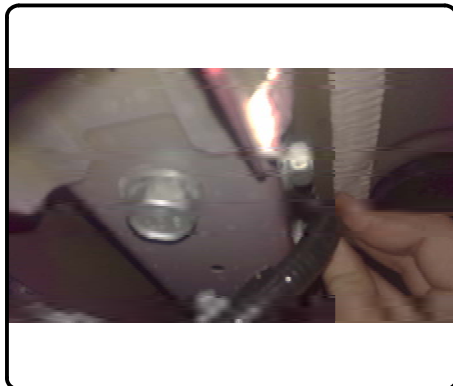

INSTALLATION WALKTHROUGH:

3. Fishwire rear and side mounting hole hardware through the access hole in the vehicle frame. Reverse fishwire remaining hardware through the access hole (both sides).
Trailhawk models: Only use "reverse fishwire hardware" and the vehicle M14 bolts previously removed.

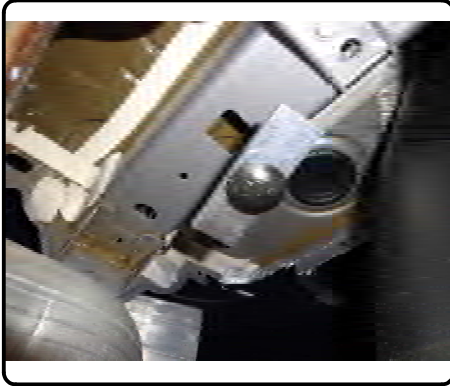

4. Raise hitch up from in front of the exhaust and into position, using care not to push hardware back inside frame. Be sure to loosely secure hitch with the mounting hardware to align all holes before tightening.
Note: Seam foam may need to be trimmed for proper mounting plate fit.



5. As needed, resecure wire to vehicle frame rail.

Torque all 1/2" hardware to 110 lb-ft.

Trailhawk: Torque all M14 hardware to 139 lb-ft.

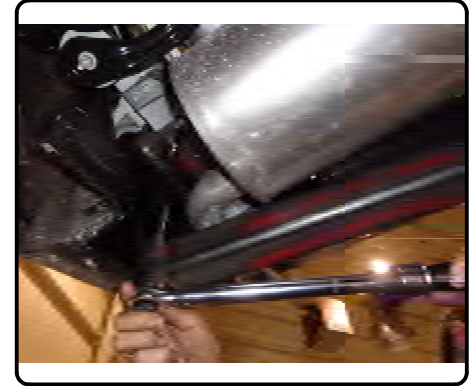

6. Trailhawk models: Clip plastic fascia panels into place and secure with (4) screws.

Installation Complete



TOWING SAFETY INFORMATION

Gross Trailer Weight / GTW

The Gross Trailer Weight is the weight of the trailer & cargo. Measure this by putting the fully loaded trailer on a vehicle scale.

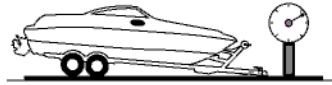

Tongue Weight / TW

The downward force that is exerted on the hitch ball by the coupler. The tongue weight will vary depending on where the load is positioned in relationship to the trailer axle(s). To measure the tongue weight, use either a commercial scale or a bathroom scale with the coupler at towing height. When using a bathroom scale with heavier tongue weights, use the method shown and multiply the scale reading by 3.

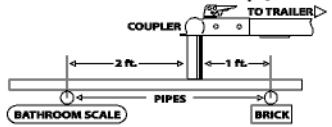

Weight Carrying / WC

The total weight of both the trailer and the cargo inside. Never exceed the weight capacity of your trailer hitch.

Weight Distribution / WD

Used to balance the weight of the cargo between the front and rear wheels throughout the trailer, allowing for better steering, braking, and level riding.



Sway Control

A device used to reduce the lateral movements of the trailer that are caused by the wind. This works in conjunction with a weight distribution hitch. Do not use this on a class 1 or 2 hitch, or with surge brakes.

How Much Can You Safely Tow?

TONGUE WEIGHT (lb)	1000	2000	3000	4000	5000	6000	7000	8000	10,000	12,000
Tongue weights should be about 10 to 15 percent of the gross trailer weight.										
CLASS 1										
CLASS 2										
CLASS 3										
CLASS 4										
CLASS 5										
TRAILER TYPE										
Camper	11'	12'	13'	14'	15'	16'				
lbs.	1100	1200	1300	1400	1500	1600				
Vacation	18'	19'	20'	21'	22'	24'	26'	28'	30'	32'
lbs.	2100	2400	2700	3000	3300	3600	3900	4200	4500	4800
Vacation	18'	19'	20'	21'	22'	24'	26'	28'	30'	32'
lbs.	2800	3200	3600	4000	4400	4800	5200	5600	6000	6400
5th Wheel										

Refer to owner's manual for towing capabilities and limitations.

Ball Mount

The ball mount is placed inside the opening of the receiver hitch which is mounted to the vehicle. Make sure a hitch pin and clip is properly securing the ball mount to the receiver hitch before you begin towing.

- A: Rise. B: Drop. C: Hole Size. D: Length.

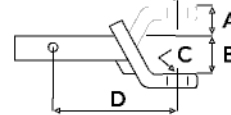

Trailer Ball

The connection from the hitch to the trailer. There are many factors that determine the correct hitch ball:

- Number one is the hitch ball's gross trailer weight rating.
- The mounting platform must be at least 3/8" thick.
- The hole diameter must not be more than 1/16" larger than the threaded shank.
- Every time you tow, check the nut and lock washer to make sure they are fastened securely.
- A: Ball Dia. B: Shank Length. C: Shank Dia. D: Shank Rise.

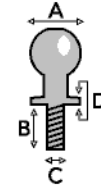

Coupler

The component that is placed over the trailer ball to connect the vehicle to the trailer. Be sure that the coupler size matches the size of the hitch ball and that the coupler handle is securely fastened. To determine what size hitch ball you need for your application you will need to know the size of coupler that is on the trailer. Be sure your coupler is properly adjusted to the ball you are using.

NOTE: For added security the use of safety devices such as Coupler Safety Pins and Locks is strongly recommended.

Safety Chains

Safety chains are a requirement and should be crossed under the tongue of the trailer so that the tongue will not drop to the road if it becomes separated from the hitch. Always leave enough slack so you can turn. Never allow the safety chains to drag on the ground and never attach the chains to the bumper.

Trailer Classification: Safety Chain Breaking Force - Minimum

Class 1: 2,000 lbs. (8.9 kN)

Class 2: 3,500 lbs. (15.6 kN)

Class 3: 5,000 lbs. (22.2 kN)

The strength rating of each length of safety chain or its equivalent and its attachments shall be equal to or exceed in minimum breaking force the GVWR (Gross Vehicle Weight Rating) of the trailer.

Electrical

Trailer lights, Electric Brakes, Break-away systems - Every time you tow, be sure to check that all components are working properly.

Wiring identification by color:

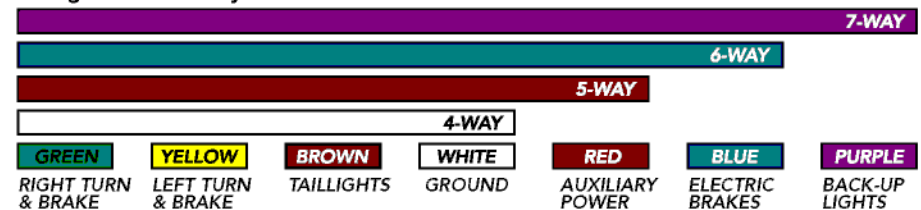

CURT DISCLAIMER: WIRING COLOR SHOWN WORK IN CONJUNCTION WITH CURT MANUFACTURING PRODUCTS.

13171 JEEP CHEROKEE (ALL MODELS INCLUDING TRAILHAWK)

2/26/2014

GROSS LOAD CAPACITY WHEN USED AS A WEIGHT CARRYING HITCH: 5,000 LBS. TRAILER WEIGHT & 750 LBS. TONGUE WEIGHT.
GROSS LOAD CAPACITY WHEN USED AS A WEIGHT DISTRIBUTION HITCH: 6,000 LBS. TRAILER WEIGHT & 750 LBS. TONGUE WEIGHT

DO NOT EXCEED VEHICLE MANUFACTURER'S RECOMMENDED TOWING CAPACITY.

HAVING INSTALLATION QUESTIONS? CALL TECHNICAL SUPPORT AT 1-800-798-0813

Parts List			
ITEM	QTY	PART NUMBER	DESCRIPTION
1	6	HFN 1213, GR8	HEX FLANGE NUT
2	6	1/2-13 x 1 1/2, GR8	CARRIAGE BOLT
3	6	1_2 FISHWIRE	1/2" FISHWIRE
4	6	CM-SP6	.250 x 1.00 x 3.00" SQUARE HOLE SPACER

TOOLS REQUIRED	
RATCHET	
3/4", 8mm, 21mm SOCKET	
6" SOCKET EXTENSION	
TORQUE WRENCH	

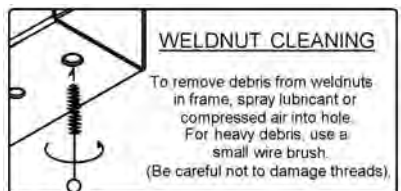
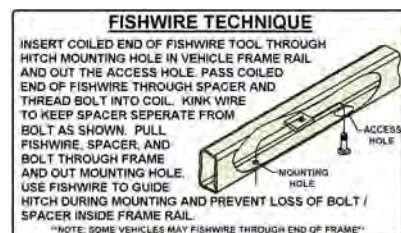
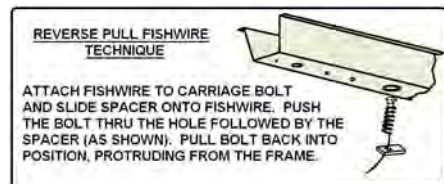

HITCH WEIGHT: 48 LBS.

INSTALL TIME

PROFESSIONAL: 30 MINUTES

NOVICE (DIY): 60 MINUTES

INSTALL NOTES:

- NO DRILLING
- FISHWIRE HARDWARE
- REVERSE FISHWIRE HARDWARE
- TRAILHAWK: TEMP. REMOVE FASCIA

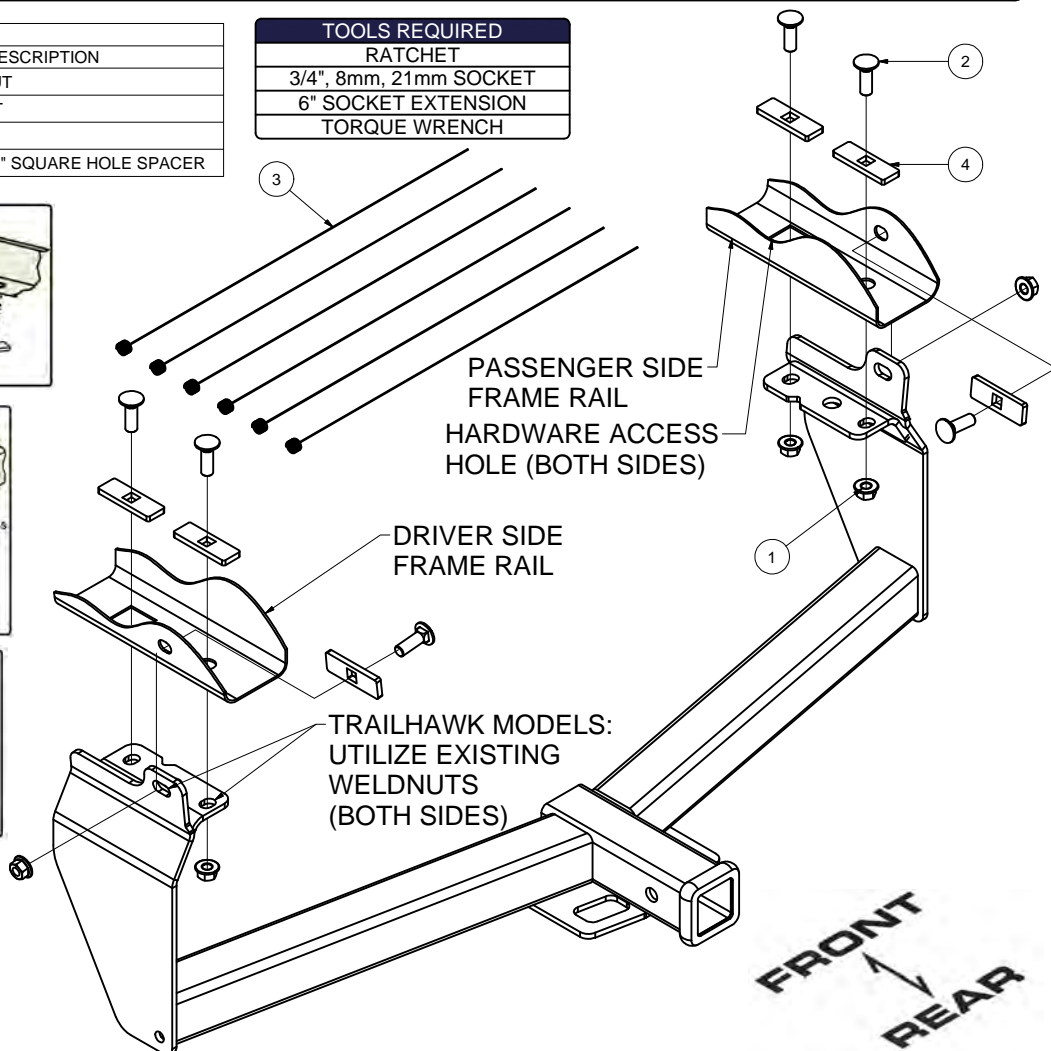

INSTALLATION STEPS

- Trailhawk models: Temporary plastic fascia removal is required for install. Remove (4) screws with a 10mm socket from the bottom of the panel, and push on tabs to unclip. Set aside for reassembly.
- Examine vehicle frame rails - If wire is present on either side frame rail, unfasten by pulling retainer out of the frame and temporarily let hang loose below frame rail. Remove square rubber plug on each side of the frame rails to expose access holes. Return plugs to owner.
- Fishwire rear and side mounting hole hardware through the access hole in the vehicle frame. Reverse fishwire remaining hardware through the access hole (both sides). Trailhawk models: Only use "reverse fishwire hardware" and the vehicle M14 bolts previously removed.
- Raise hitch up from in front of the exhaust and into position, using care not to push hardware back inside frame. Be sure to loosely secure hitch with the mounting hardware to align all holes before tightening. Note: Seam foam may need to be trimmed for proper mounting plate fit.
- As needed, resecure wire to vehicle frame rail. Torque all 1/2" hardware to 110 lb-ft. Trailhawk models: Torque all M14 hardware to 139 lb-ft.
- Trailhawk models: Clip plastic fascia panel into place and secure with (4) screws.

PERIODICALLY CHECK THIS RECEIVER HITCH TO ENSURE THAT ALL FASTENERS ARE TIGHT AND THAT ALL STRUCTURAL COMPONENTS ARE SOUND.



Scan for more information

Curt Manufacturing LLC., warrants this product to be free of defects in material and/or workmanship at the time of retail purchase by the original purchaser. If the product is found to be defective, Curt Manufacturing LLC., may repair or replace the product, at their option, when the product is returned, prepaid, with proof of purchase. Alteration to, misuse of, or improper installation of this product voids the warranty. Curt Manufacturing LLC.'s liability is limited to repair or replacement of products found to be defective, and specifically excludes liability for incidental or consequential loss or damage.