

13339**1999-PRESENT CHEVROLET / GMC 1500 AND 2500 LIGHT DUTY
WITH 10" STEP BUMPER (COMPATIBLE WITH TOMMYGATE)****10/12/2012**

GROSS LOAD CAPACITY WHEN USED AS A WEIGHT CARRYING HITCH: 8,000 LBS. TRAILER WEIGHT & 800 LBS. TONGUE WEIGHT.
 GROSS LOAD CAPACITY WHEN USED AS A WEIGHT DISTRIBUTION HITCH: 12,000 LBS. TRAILER WEIGHT & 1,200 LBS. TONGUE WEIGHT

***** DO NOT EXCEED VEHICLE MANUFACTURER'S RECOMMENDED TOWING CAPACITY.*****

HAVING INSTALLATION QUESTIONS? CALL TECHNICAL SUPPORT AT 1-800-798-0813

Parts List			
ITEM	QTY	PART NUMBER	DESCRIPTION
1	6	1/2-13	HEX NUT
2	6	1/2-13 x 1 3/4	HEX BOLT
3	6	1/2"	LOCK WASHER
4	6	CM-SP50	.250 x 1.00 x 1.50" ROUND HOLE SPACER
5	2	CM-SP34	.188 x 1.50 x 3.00" ROUND HOLE SPACER
6	4	CM-SP22	.250 x 1.50 x 1.50" ROUND HOLE SPACER

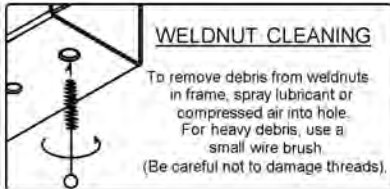

TOOLS REQUIRED
SOCKET WRENCH
3/4" WRENCH
22mm SOCKET
TORQUE WRENCH

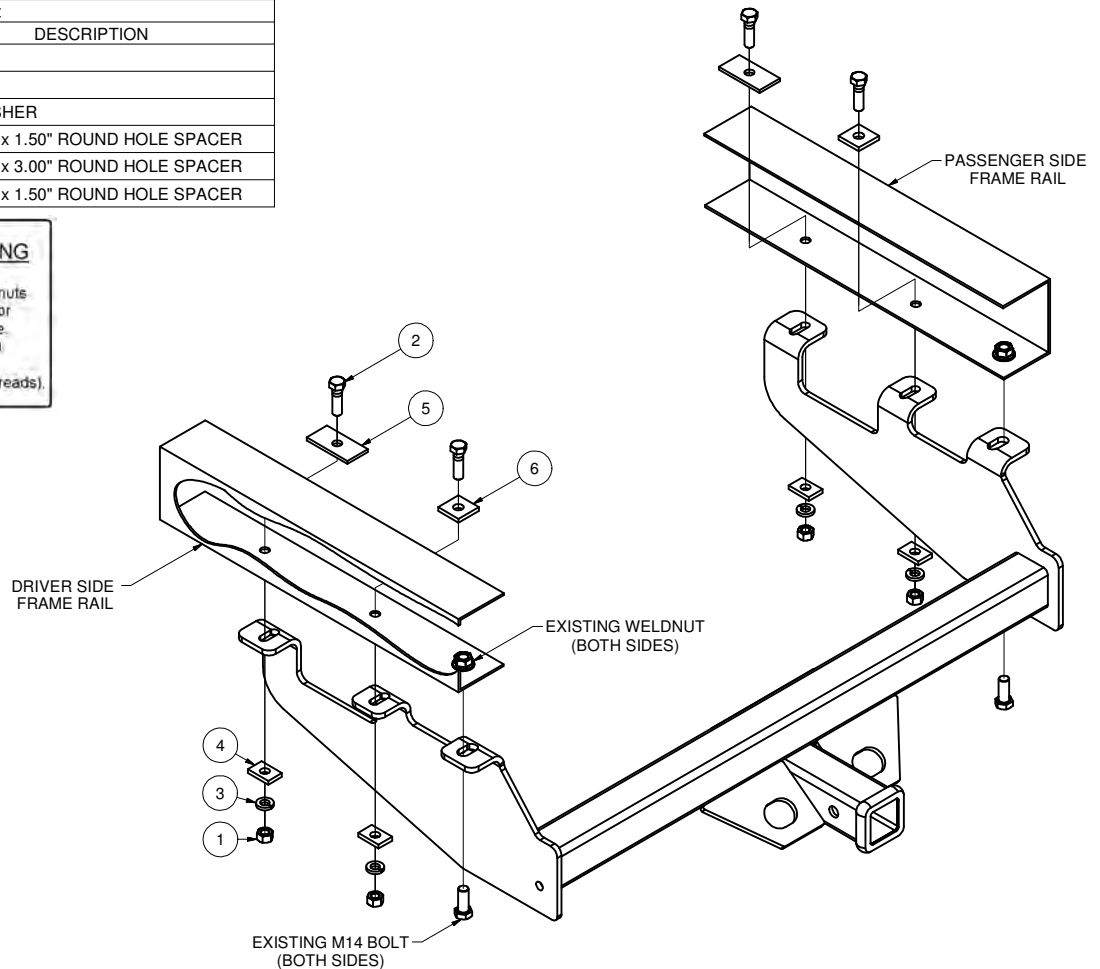

HITCH WEIGHT: 53 LBS.

INSTALL TIME: 30 MINUTES

INSTALL NOTES:

- NO DRILLING REQUIRED
- REMOVE BUMPER BRACKET BOLT
- LOWER SPARE TIRE

INSTALLATION STEPS

1. Lower spare tire for ease of installation.
2. If present, remove M14 bolts from bumper bracket.
3. Raise hitch into position and reinstall M14 bolt removed in Step 2.
4. Install 1/2-13 hex bolts and CM-SP22 spacers through middle holes.
Note: If M14 bolt and weldnut do not exist on vehicle, use the supplied 1/2-13 hex bolts and CM-SP22 spacers in the rear hole as well.
5. Install 1/2-13 hex bolts and CM-SP34 spacers through forward holes.
6. Secure hitch with CM-SP50 spacers, lock washers and hex nuts as shown.
7. Torque 1/2" hardware to 110 lb-ft.
8. Reinstall spare tire.

PERIODICALLY CHECK THIS RECEIVER HITCH TO ENSURE THAT ALL FASTENERS ARE TIGHT AND THAT ALL STRUCTURAL COMPONENTS ARE SOUND.

Curt Manufacturing Inc., warrants this product to be free of defects in material and/or workmanship at the time of retail purchase by the original purchaser. If the product is found to be defective, Curt Manufacturing Inc., may repair or replace the product, at their option, when the product is returned, prepaid, with proof of purchase. Alteration to, misuse of, or improper installation of this product voids the warranty. Curt Manufacturing Inc.'s liability is limited to repair or replacement of products found to be defective, and specifically excludes liability for incidental or consequential loss or damage.