

INSTALLATION INSTRUCTIONS

WARNING: NEVER EXCEED YOUR VEHICLE MANUFACTURER'S RECOMMENDED TOWING CAPACITY

HITCH-MOUNTED PREMIUM BIKE RACK



WARNINGS

The tow vehicle must be equipped with a trailer hitch with 2" receiver tube opening.

Check straps for wear, and replace if worn.

This product is not intended for off-road use, tandems or recumbents.

Do not install on a trailer or other towed vehicle.

Check tightness of all bolts periodically.

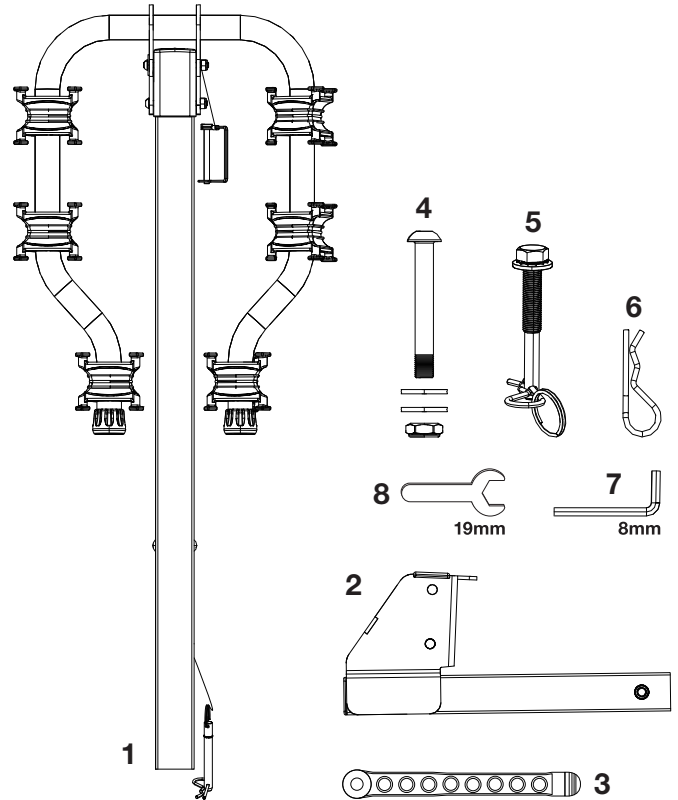

PARTS LIST

Item#	Qty	Description
1	1	Arm post
2	1	Shank, 2"
3	9	Arm straps, rubber
4	1	Bolt kit, hex head (bolt, two washers, nut)
5	1	Anti-rattle bolt and clip
6	1	Clip
7	1	Allen wrench, 8mm
8	1	Wrench, 19mm

ASSEMBLY

Step 1

Raise the arms on the arm post (#1) to the outright position and secure with the attached lynch pin. See figure 1-A.

Step 2

Using the hex head bolt kit (#4), attach the bottom of the arm post (#1) to the shank (#2). Make sure to install the bolt in the bottom hole. See figure 1-B. Insert the bolt that is connected to the main body through the top hole of the shank and secure with the provided clip (#6). See figure 1-C.

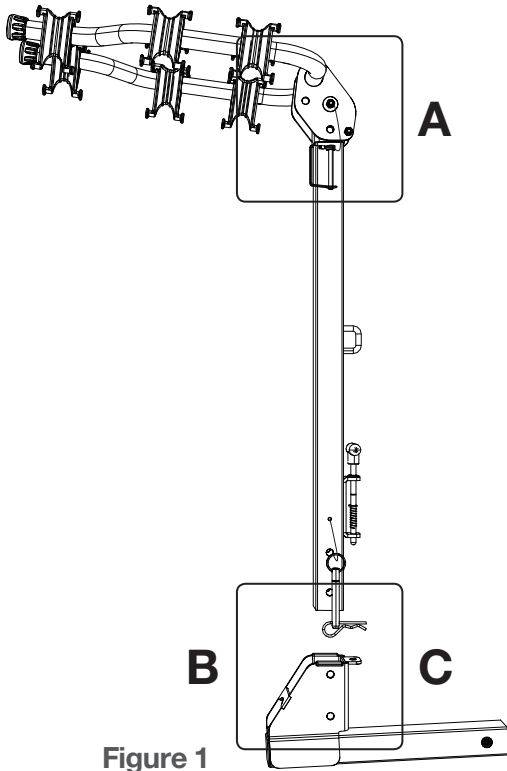

Figure 1

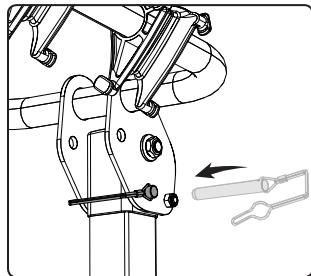

Figure 1-A

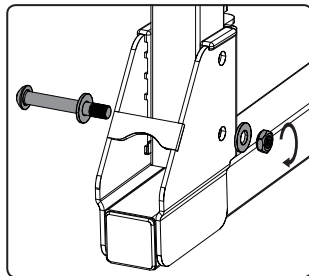

Figure 1-B

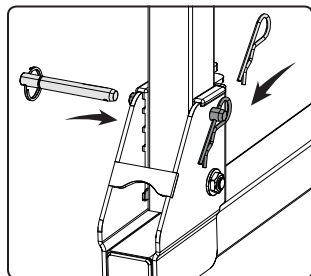
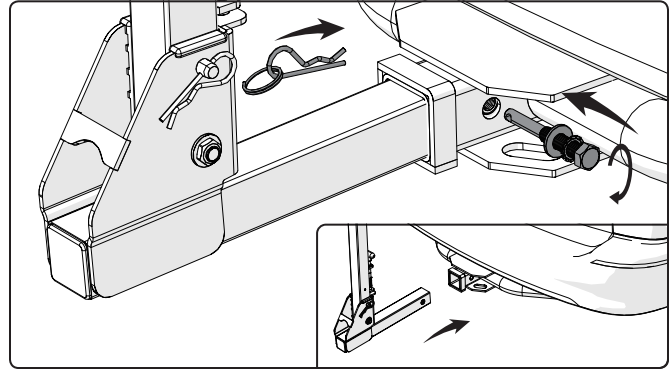

Figure 1-C

INSTALLATION

Step 1

Insert the bike rack shank into the vehicle receiver tube. Secure with 1/2" hex head bolt, flat washer, star washer and clip (#5).



Step 2

Install the bikes on the rack and secure with the provided rubber bike arm straps (#3). Be sure to secure the cross post and seat post to the rack. **Note:** When towing more than one bike, be sure to alternate the directions the bikes are facing on the rack. First bike faces right, 2nd bike faces left and so on. See the figure below.

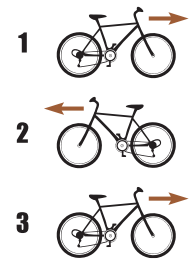
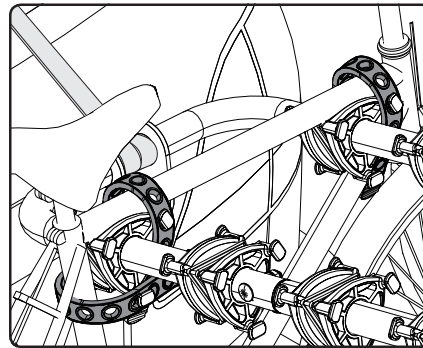

FOLDING FEATURES

At the base, remove the clip from the upper bolt holding the bike rack in the vertical position. Remove the bolt and tilt the rack away from the vehicle. The rear cargo area is now accessible.

At the top, pull the lynch pin that secures the arms in the outward position. Fold the bike rack arms down to the transport position, and replace the lynch pin.

