



Safety glasses should be worn at all times while installing this product.

YEARS: 2007-2009

MAKE: HYUNDAI

MODEL: SANTA FE

STYLE: SUV

WARNING: NEVER EXCEED YOUR VEHICLE MANUFACTURER'S RECOMMENDED TOWING CAPACITY







WEIGHT CARRYING:
 TRAILER WEIGHT: 3,500 LBS.
 TONGUE WEIGHT: 350 LBS.

**GROSS LOAD CAPACITY WHEN USED AS A STRAIGHT LINE PULL:
 9,000 LBS MAX.**

INSTALLATION TIME: 45 MIN.

THE INSTALL TIME LISTED IS FOR PROFESSIONAL INSTALLERS. IF YOU ARE HESITANT TO UNDERTAKE THIS TASK ON YOUR OWN, CONTACT AN AUTHORIZED CURT INSTALLER FOR ADDITIONAL ASSISTANCE.



INSTALLATION REQUIRES:

 RATCHET	 10" SOCKET EXTENSION	 12mm 13mm 11/16" 3/4" SOCKET
 TORQUE WRENCH	 TAPE MEASURE	 DIE GRINDER
 SAFETY GLASSES		

INSTALLATION TIPS:

- BEFORE YOU BEGIN INSTALLATION, READ ALL INSTRUCTIONS THOROUGHLY.
- TO EASE INSTALLATION, 2 PEOPLE MAY BE REQUIRED.
- USING PROPER TOOLS WILL GREATLY IMPROVE THE QUALITY OF THE INSTALL AND REDUCE THE TIME REQUIRED.
- NEED HELP OR HAVE SOME QUESTIONS? CALL TECHNICAL SUPPORT AT 800.798.0813

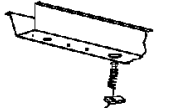
LEVEL OF DIFFICULTY: MODERATE

EASY	MODERATE	HARD
	FISHWIRE HARDWARE	
	HOLE ENLARGEMENT	
	PART REMOVAL	

VEHICLE PHOTO:



REPRESENTATIVE PHOTO

HITCH ILLUSTRATION:

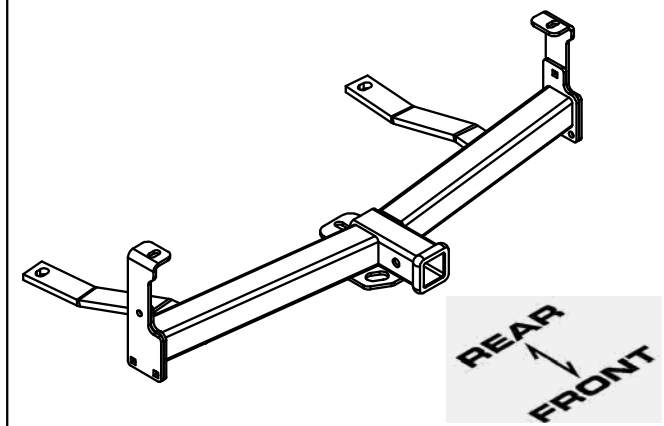

MAKE SURE YOUR HITCH MATCHES

PERIODICALLY CHECK THIS RECEIVER HITCH TO ENSURE ALL FASTENERS ARE TIGHT AND ALL STRUCTURAL COMPONENTS ARE SOUND

CURT Manufacturing Inc. warrants this product to be free of defects in material and/or workmanship at the time of retail purchase by the original purchaser. If the product is found to be defective, Curt Manufacturing Inc. may repair or replace the product at their option, when the product is returned, prepaid, with proof of purchase. Alteration to, misuse of, or improper installation of this product voids the warranty. Curt Manufacturing Inc.'s liability is limited to repair or replacement of products found to be defective, and specifically excludes liability for incidental or consequential loss or damage.

For more information log onto www.curtmfg.com, & for helpful towing tips log onto www.hitchinfo.com

INSTALLATION WALKTHROUGH:

Parts List			
ITEM	QTY	PART NUMBER	DESCRIPTION
1	1	CM-31035-DS	.250" DRIVER SIDE PLATE
2	1	CM-31035-PS	.250" PASSENGER SIDE PLATE
3	6	7/16-14 x 1 1/4	CARRIAGE BOLT
4	2	CM-SP11	.250 x 1.00 x 2.50" SQUARE HOLE SPACER
5	2	7/16-14 x 1 1/2	CARRIAGE BOLT
6	8	7/16-14	HEX FLANGE NUT
7	2	M8-1.25 x 35	HEX BOLT
8	2	3/8"	FENDER WASHER
9	1	CM-SP53	.250 x 1.50 x 3.00" SQUARE HOLE SPACER
10	1	HFN 1213	HEX FLANGE NUT
11	1	1/2 - 13 x 2"	CARRIAGE BOLT
12	2	7_16 FISHWIRE	7/16" FISHWIRE

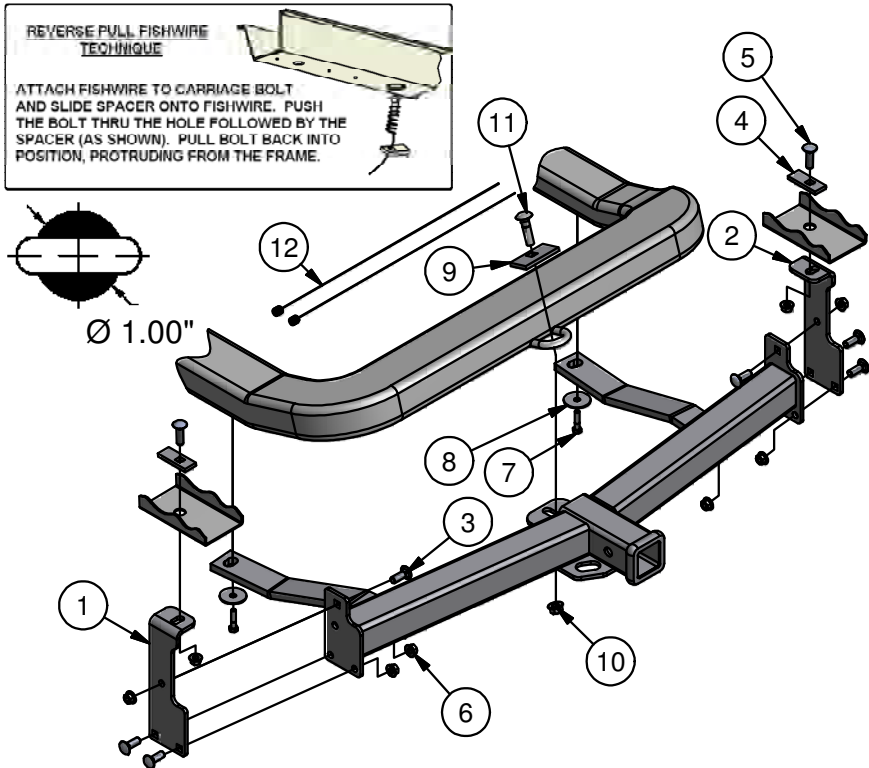

1. Remove the underbody panel on the front of the vehicle by removing the (6) M8-1.25 bolts. Save and return to vehicle owner with hardware for reinstallation should the hitch be removed.



2. Remove the (2) rubber plugs in the frame rail. Enlarge these holes to accept a spacer (CM-SP11) and a 7/16-14 carriage bolt as shown in the diagram.

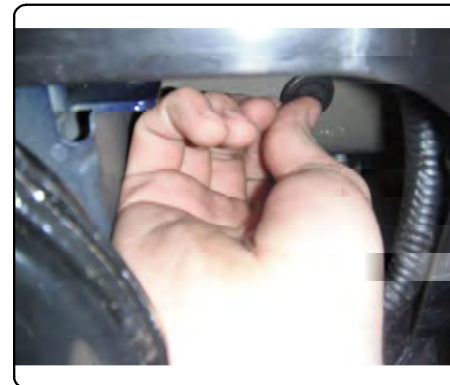

INSTALLATION WALKTHROUGH:

3. Fishwire the 7/16-14 x 1 1/2" carriage bolt and spacer (CM-SP11) into frame as shown, see "REVERSE PULL FISHWIRE TECHNIQUE".

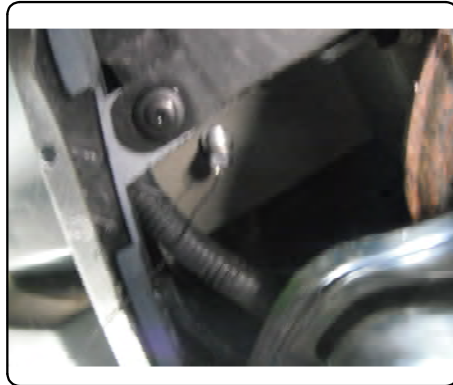
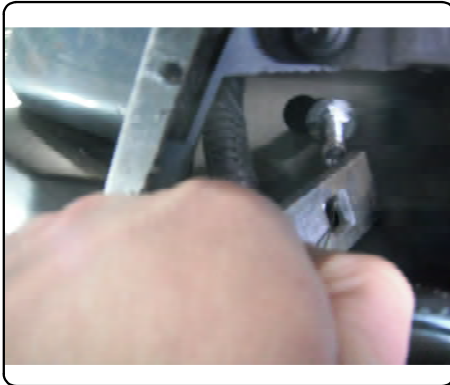

4. Install side plates using hardware from previous step and 7/16-14 flange nuts. Measure hitch center section and space side plates accordingly. Torque 7/16-14 carriage bolts to 70 ft-lbs.

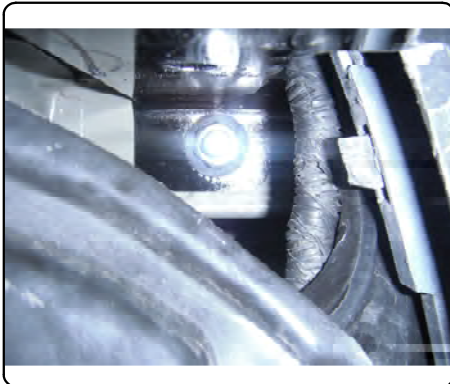

5. Raise hitch into position. Loosely install 7/16-14 x 1-1/4" carriage bolts and hex flange nuts through bottom (2) holes in the side plates and hitch.

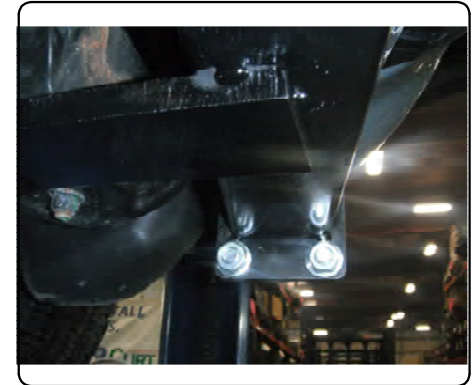
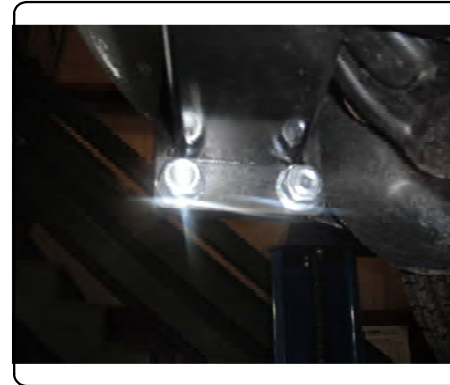

6. Install M8-1.25 x 35mm bolts and 3/8" fender washer through straps into existing welds nuts in suspension frame.

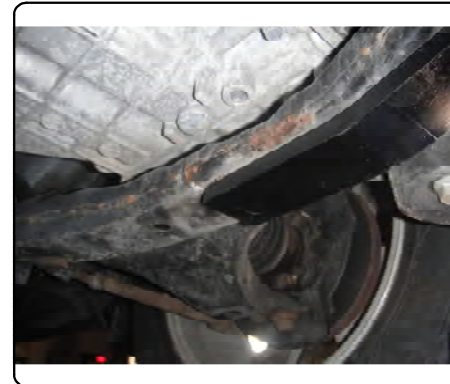

INSTALLATION WALKTHROUGH:

7. Place the 1/2-13 x 2" carriage bolt and spacer (CM-SP53) on the tow loop as shown. Install 1/2-13 flange nut onto bolt.



8. Fishwire the top 7/16-14 x 1-1/4" bolt through hitch and side plates and install 7/16-14 hex flange nuts.



9. Torque all 7/16-14 hardware to 70 ft-lbs, 1/2-13 hardware to 110 ft-lbs, and all M8-1.25 hardware to 23 ft-lbs

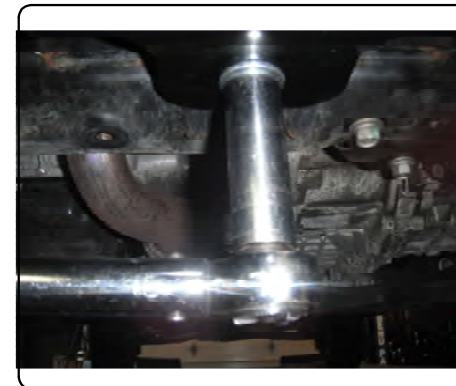

10. Install is now complete



31035**HYUNDAI SANTA FE**

12/10/2012

GROSS LOAD CAPACITY WHEN USED AS A WEIGHT CARRYING HITCH: 3,500 LBS. TRAILER WEIGHT & 350 LBS. TONGUE WEIGHT.**GROSS LOAD CAPACITY WHEN USED AS A STRAIGHT LINE PULL: 9,000 LBS. MAX. LINE PULL.******* DO NOT EXCEED VEHICLE MANUFACTURER'S RECOMMENDED TOWING CAPACITY. *******HAVING INSTALLATION QUESTIONS? CALL TECHNICAL SUPPORT AT 1-800-798-0813**

Parts List			
ITEM	QTY	PART NUMBER	DESCRIPTION
1	1	CM-31035-DS	.250" DRIVER SIDE PLATE
2	1	CM-31035-PS	.250" PASSENGER SIDE PLATE
3	6	7/16-14 x 1 1/4	CARRIAGE BOLT
4	2	CM-SP11	.250 x 1.00 x 2.50" SQUARE HOLE SPACER
5	2	7/16-14 x 1 1/2	CARRIAGE BOLT
6	8	7/16-14	HEX FLANGE NUT
7	2	M8-1.25 x 35	HEX BOLT
8	2	3/8"	FENDER WASHER
9	1	CM-SP53	.250 x 1.50 x 3.00" SQUARE HOLE SPACER
10	1	HFN 1213	HEX FLANGE NUT
11	1	1/2 - 13 x 2"	CARRIAGE BOLT
12	2	7_16 FISHWIRE	7/16" FISHWIRE

TOOLS REQUIRED
RATCHET
10" EXTENSION
12mm, 13mm SOCKET
11/16", 3/4" SOCKET
DIE GRINDER
TORQUE WRENCH
TAPE MEASURE

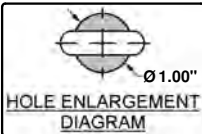
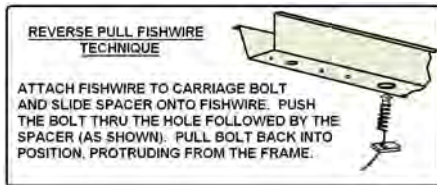
**HITCH WEIGHT: 42 LBS.****INSTALL TIME**

PROFESSIONAL: 45 MINUTES

NOVICE (DIY): 90 MINUTES

INSTALL NOTES:

- HOLE ENLARGEMENT REQUIRED
- UNDERBODY PANEL REMOVAL
- FISHWIRE FASTENERS

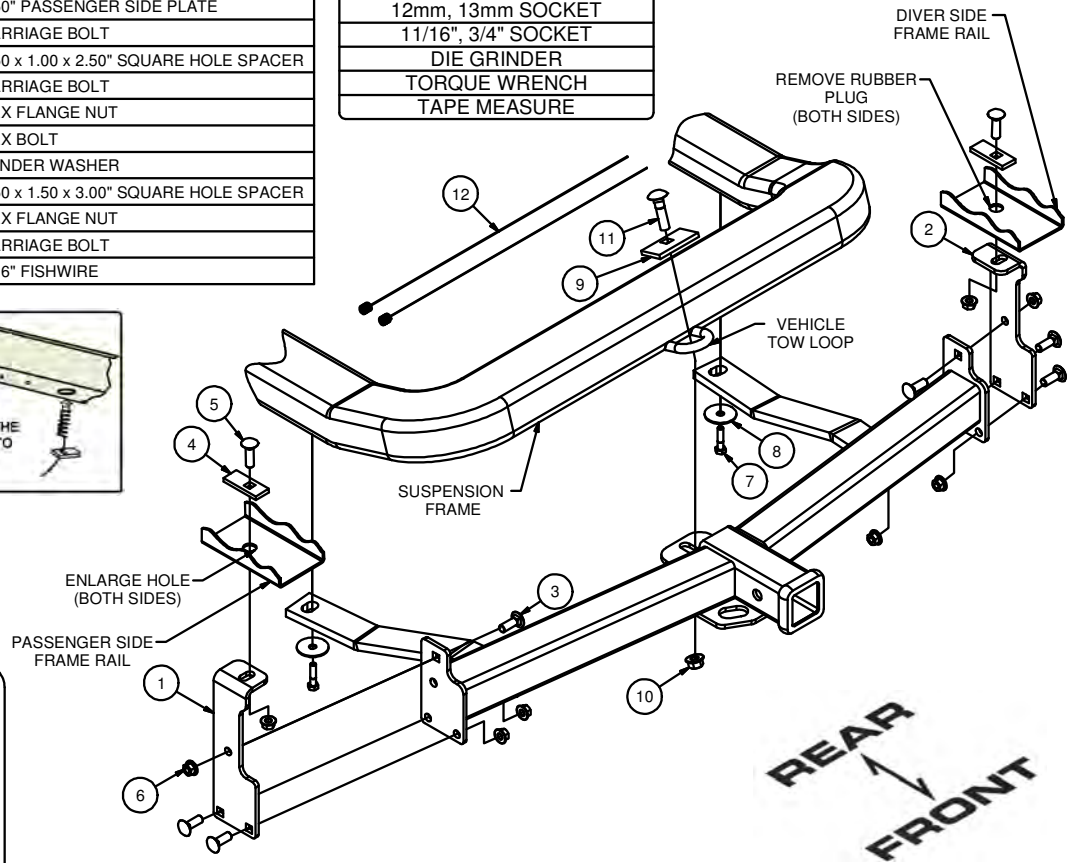
**INSTALLATION STEPS**

1. Remove the underbody panel on the front of the vehicle by removing the (6) M8-1.25 bolts. Save and return panel and hardware to vehicle owner for reinstallation should the hitch be removed.
2. Remove the (2) rubber plugs in the frame rail. Enlarge these holes to accept a spacer (CM-SP11) and a 7/16-14 carriage bolt as shown in the diagram above.
3. Fishwire the 7/16-14 x 1 1/2" carriage bolts and spacers (CM-SP11) into the frame as shown, see "REVERSE PULL FISHWIRE TECHNIQUE".
4. Install side plates using hardware from previous step and 7/16-14 flange nuts. Measure hitch center section and space side plates accordingly. Torque 7/16-14 carriage bolts to 50 ft-lb
5. Raise hitch into position. Loosely install 7/16-14 x 1-1/4" carriage bolts and hex flange nuts through bottom (2) holes in side plates and hitch.
6. Loosely install M8-1.25 x 35mm bolts and fender washer through straps into existing weld nuts in suspension frame.
7. Place the 1/2-13 x 2" carriage bolt and spacer (CM-SP53) on the tow loop as shown. Loosely install 1/2-13 flange nut onto bolt that goes through tow loop.
8. Fishwire the top 7/16-14 x 1-1/4" bolt through hitch and side plates and loosely install 7/16-14 hex flange nuts.
9. Torque all 7/16-14 hardware to 70 ft-lb, 1/2-13 hardware to 110 ft-lb, and all M8-1.25 hardware to 23 ft-lb.

PERIODICALLY CHECK THIS RECEIVER HITCH TO ENSURE THAT ALL FASTENERS ARE TIGHT AND THAT ALL STRUCTURAL COMPONENTS ARE SOUND.

Curt Manufacturing Inc., warrants this product to be free of defects in material and/or workmanship at the time of retail purchase by the original purchaser. If the product is found to be defective, Curt Manufacturing Inc., may repair or replace the product, at their option, when the product is returned, prepaid, with proof of purchase. Alteration to, misuse of, or improper installation of this product voids the warranty. Curt Manufacturing Inc.'s liability is limited to repair or replacement of products found to be defective, and specifically excludes liability for incidental or consequential loss or damage.

*****DO NOT EXCEED VEHICLE MANUFACTURER'S RECOMMENDED TOWING CAPACITY ***.**

FRONT MOUNTED ACCESSORIES

1) Do not exceed front axle Gross Weight Rating (GAWR). Consult owners manual or specification plate located on driver's door frame. Measure gross front axle weight by placing front wheels of loaded vehicle on a scale.

WARNING: Exceeding GAWR may overload the front axle and/or suspension. This could result in **accident, property damage and personal injury.**

- 2) Reposition front mounted license plate if obstructed.
- 3) Do not obstruct vehicle lights.
- 4) Allow free air flow into grille opening.
- 5) Rear wheel traction may be reduced. This could effect handling. Reduce speed and drive with caution.
- 6) Accessories extend front of vehicle. This may reduce approach angle. Use caution when parking and maneuvering.
- 7) Do not obstruct driver view.

VEHICLE RECOVERY AND WINCHING TIPS

1) Use OEM tow hooks, recovery eyes or a clevis mount for attachment of a tow strap or winch cable.

WARNING: NEVER use a ball and/or ball mount as an anchor point for tow strap or winch cable. Severe personal injury or death could result.

- 2) Observe winch manufacturer's recommendations, cautions and warnings.
- 3) Attach return cable to tow hook or recovery eye when using a snatch block (See figure 1).

CAUTION: Do not attach return cable to winch mount. This may overload winch mount and/or front mounted receiver.

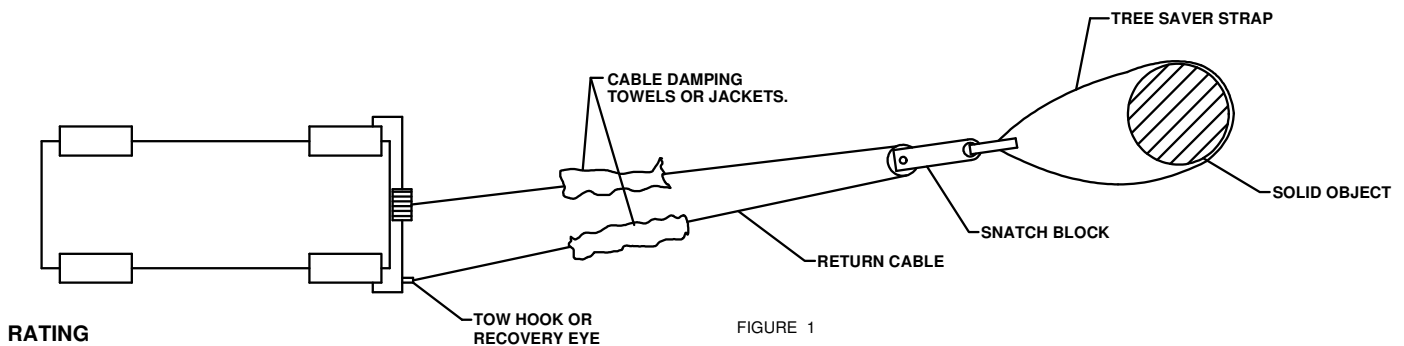

RATING

For **Maximum** line pull rating, winch cable must not exceed:

- 15 degree angle up or down from horizontal (See Figure 2).
- 45 degree angle left or right from straight ahead (See Figure 3).

CAUTION: Exceeding the maximum line pull rating may over load winch, winch mount, and/or front mounted receiver.

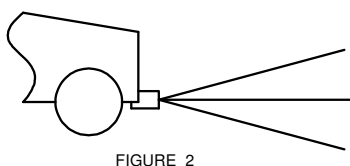

FIGURE 2

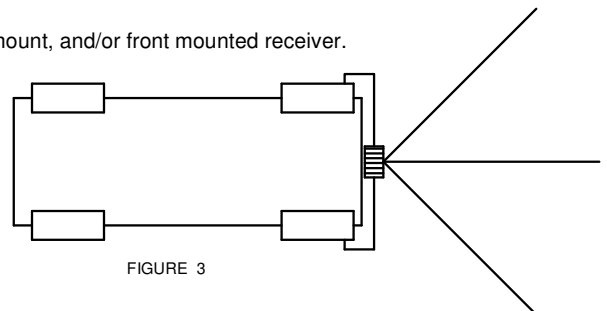

FIGURE 3