



**Before returning this product  
to the store of purchase**

**Contact Dee Zee if you experience the following problems:**

- Missing Parts
- Installation Problems/Questions
- Warranty Questions

**1.800.779.2102**

Hours of operation: 8am - 5pm CST, Mon-Friday

Review complete warranty policy and register your product at:

**[www.deezee.com](http://www.deezee.com)**



## Dee Zee Toolbox Installation Instructions

*Congratulations on your purchase of a quality Dee Zee product. Dee Zee is recognized as having the highest quality running boards and accessories on the market today. We have earned this reputation by offering our customers a product they can be proud to place on their vehicles. Dee Zee meets all the criteria of manufacturing a custom-fit product which guarantees it to be the easiest product to install.*

**Note: Please take time to read all of the instructions before beginning this installation.**

**Note: Use J-Bolt provided or WARRANTY IS VOID...DO NOT USE self tapping screws to mount.**

**Warning! If it is necessary to drill any holes into the vehicle, Dee Zee recommends putting a sealant or rust inhibitor around all holes drilled into the body of the vehicle.**

**Cleaning Instructions: To maintain the bright finish of your Dee Zee Stainless Steel Toolbox, clean with a mild detergent and then apply a high grade automotive type wax.**

**If you should happen to have any questions with this product or you have an installation question, please feel free to call us at:**

**1-800-779-8222**

**If you would like to find out more information on Dee Zee's products please feel free to visit our website at:**

**WWW.DEEZEE.COM**

# Fifth Wheel Tool Box Installation Instructions

## Fifth Wheel Toolbox:

Toolbox lid design may vary from picture with different toolbox models.

## Cinquième Boîte à outils De Roue:

La conception de couvercle de boîte à outils peut changer de l'image avec différents modèles de boîte à outils.

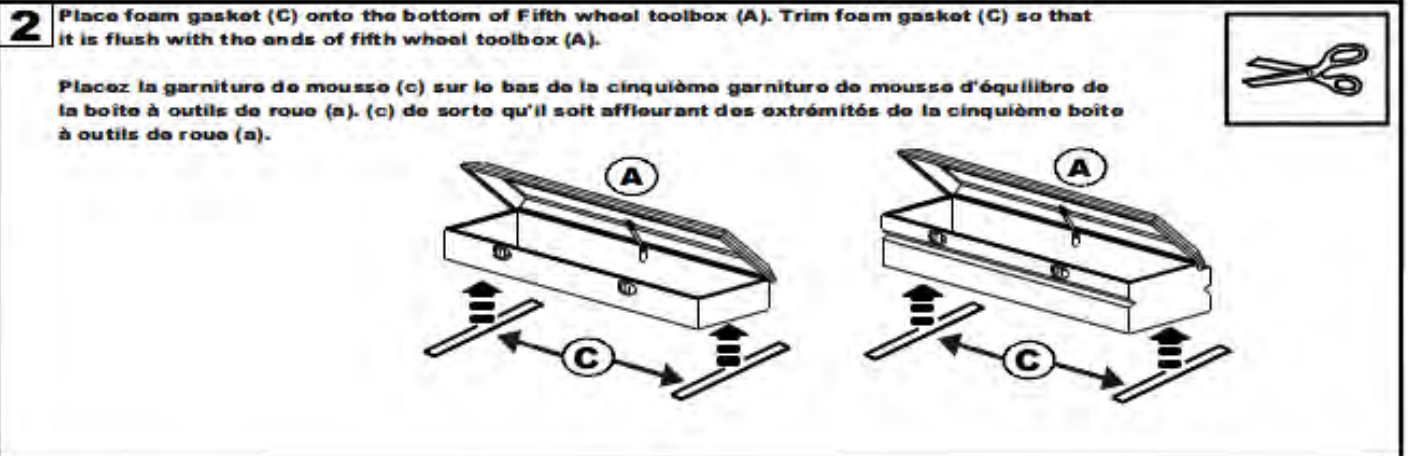
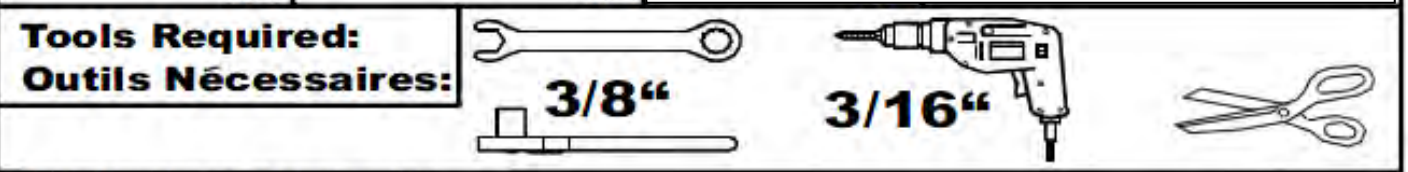
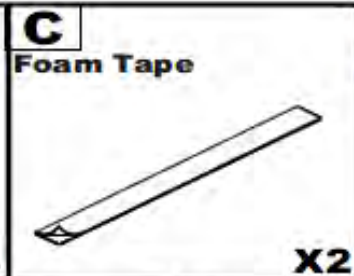
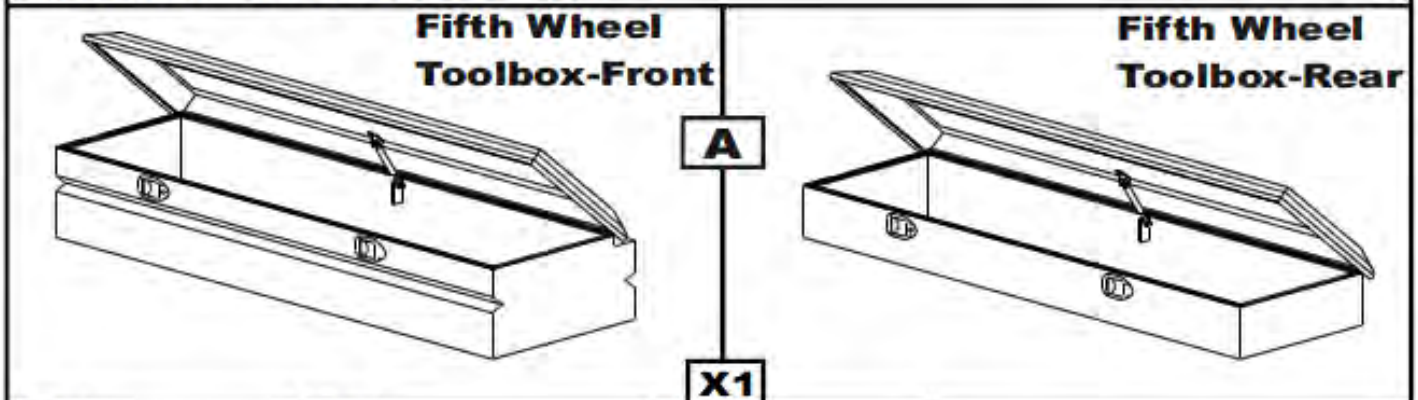

**3**



Place fifth wheel toolbox (A) into the back of your pickup truck bed.

Placez la cinquième boîte à outils de roue (a) dans le dos de votre lit de petit camion.

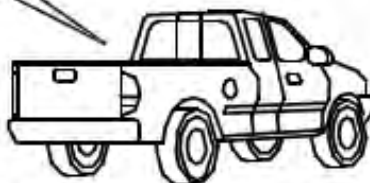

**4**

Locate the fifth wheel toolbox (A) in the pickup truck bed and then mark four hole locations in the bottom of fifth wheel toolbox (A). Drill a 3/16" hole at each marked hole location.

Placez la cinquième boîte à outils de roue (a) dans le lit de petit camion et puis marquez quatre emplacements de trou au bas de la cinquième boîte à outils de roue (a). Forez un 3/16 " trou à chaque emplacement marqué de trou.

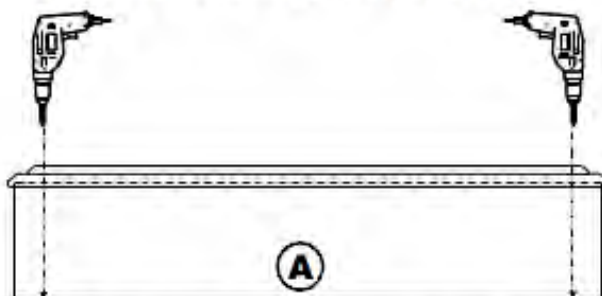
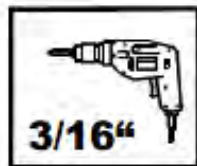

**5**

Attach fifth wheel toolbox (A) to the pickup truck bed using 1/4 x 1" sheet metal screws (B). Tighten them into place using a 3/8" wrench / or socket.

Attachez la cinquième boîte à outils de roue (a) au lit de petit camion en utilisant 1/4 x 1 " des vis en métal de feuille que (b). les serrent dans l'endroit à l'aide d'une clé de 3/8 " / ou du plot.

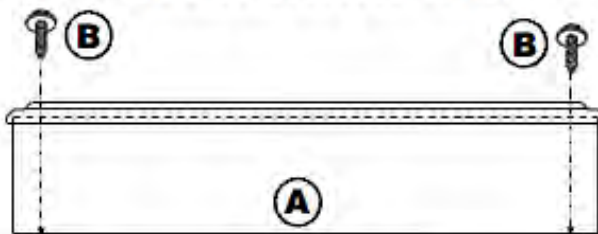

**MAINTENANCE INSTRUCTIONS:** All locks, latches, latching rods, and hinges should be lubricated regularly to assure smooth and proper operation for the life of the toolbox.

**INSTRUCTIONS D'Entretien:** Toutes les serrures, verrous, verrouillant des tiges, et des charnières devraient être lubrifiées régulièrement pour assurer l'exécution sans heurt et appropriée pendant la vie de la boîte à outils.

**Toolbox Paddle Latch Assembly**

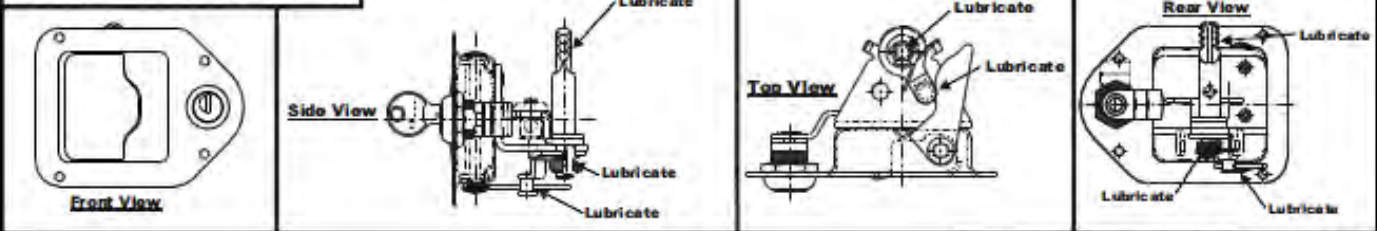

**Toolbox Catch Assembly**

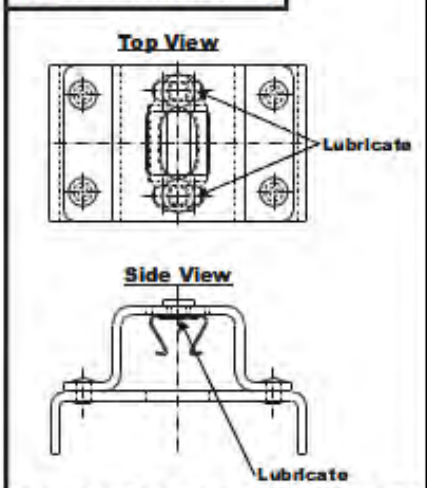

**Ever lose your keys? Save Yourself Time and Trouble?**

Order some extra keys now and have them when you need them. Please fill out and mail this portion to us. We'll send you a couple of extra keys for your Tool Box for just \$11.00 (American).

Name: \_\_\_\_\_

Day Phone: \_\_\_\_\_ - \_\_\_\_\_ - \_\_\_\_\_

Address: \_\_\_\_\_  
 \_\_\_\_\_  
 \_\_\_\_\_

Method of Payment:

- Cash, Check, or Money Order
- Master Card
- Visa

City, State, Zip: \_\_\_\_\_

Expiration Date: \_\_\_\_\_

KEY and LOCK#: \_\_\_\_\_

Card Number: \_\_\_\_\_

Please mail form and payment to : Dee Zee, Inc.  
 OR P.O. Box 3090  
 Fax to: 515-265-7926 Des Moines, IA 50316

**CLEANING INSTRUCTIONS:** To maintain the luster of your tool box, use a mild detergent.

**\*\*Locks are provided as a deterrent to inadvertent opening or easy access to the contents of your toolbox. Contents stored in the toolbox are the responsibility of the user.**

After drilling, it is recommended that a sealant or rust inhibitor be placed around all holes drilled into the body panel of the vehicle.

If you should incur any problems with the installation of this product, please feel free to call us at 1-800-779-8222. So that we may better serve you when you call, please have the W/O#, SEQUENCE#, and the DATE from the label on the outside of the box.

# Replacement Parts for 5th Wheel Toolbox

## Toolbox Hook-Paddle Latch Assembly

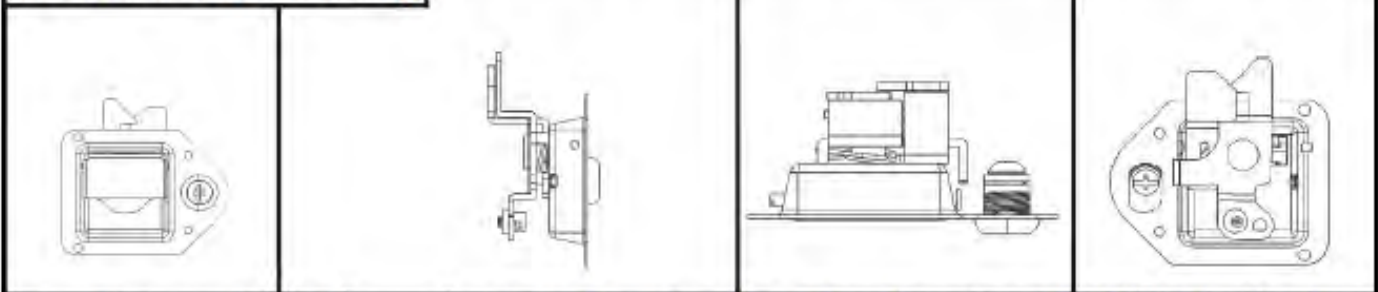

## Toolbox Hook-Catch Assembly



**C-Channel Extrusion**  
Part Number: B 1602

**Rotary Plate - Adjustable Latch**  
Part Number: B 1601

**1/4-20 Hex Head Cap Screw**  
Part Number: PN 70B

**1/4-20 Threaded Stud**  
Part Number: PN 810

**1/4-20 Flange Locknut Zinc**  
Part Number: PN 178

**1/4-20 Nylon Locknut Ultra**  
Part Number: PN 341B

**Nylon Standoff**  
Part Number: PN 860

## Pushbutton - Blue Series

**Spacer Brace for Push Button**  
Part Number: B 1623

**Adjustable Latch**  
Part Number: B 1610

**Carburetor Clip 7R**  
Part Number: LCC-2

**Mounting Bracket**  
Part Number: B 1625

**Shock Mount**  
Part Number: SL-69

**Nylon Bushing**  
Part Number: PN 116

**5/16-18 Nylon Insert Locknut**  
Part Number: PN 510

**10 x 1/2 Square Pan Self Drill**  
Part Number: PN 872

**Push Latch**  
Part Number: TB 85623

**Rotary Latch**  
Part Number: TB 85624







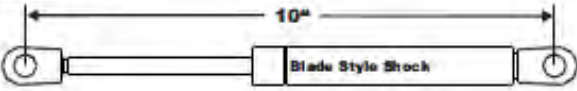
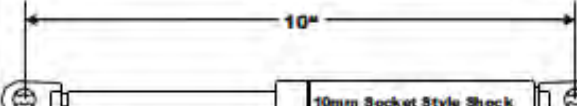
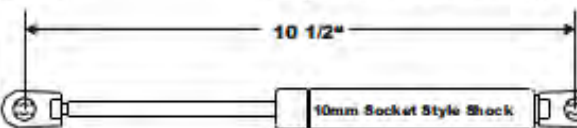
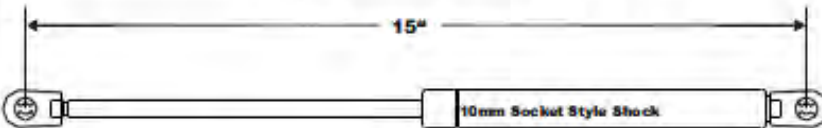



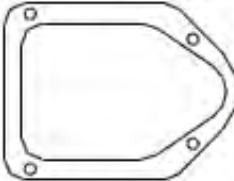



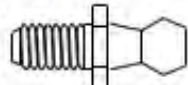
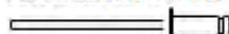

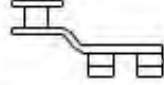

**Rod End Adaptor**  
Part Number: TB 85626

# Replacement Parts for 5th Wheel Toolbox Cont.

## Shocks

 <p>10"</p> <p>Blade Style Shock</p>	<b>Blade Style Shock</b>					
	Shock #	20#	40#	70#		
	Part Number	SL1-20	SL1-40	SL1-70		
 <p>10"</p> <p>10mm Socket Style Shock</p>	<b>10mm Socket Style Shock</b>					
	Shock #	20#	40#	70#		
	Part Number	SL-3020	SL-3040	SL-3070		
 <p>10 1/2"</p> <p>10mm Socket Style Shock</p>	<b>10mm Socket Style Shock</b>					
	Shock #	20#	40#	60#	80#	100#
	Part Number	SL-3220	SL-3240D	SL-3250D	SL-3280D	SL-32100D
 <p>15"</p> <p>10mm Socket Style Shock</p>	<b>10MM Socket Style "Lens" Style Shock</b>					
	Shock #	90#	40#			
	Part Number	SL-3390	SL-3340			

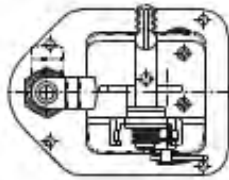
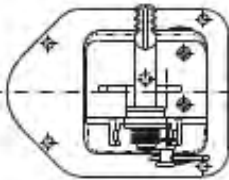
## Miscellaneous Parts

<b>Foam Latch Gasket</b> Part Number: TB85409 	<b>Shock Clip</b> Part Number: SL-81 	<b>Striker Assembly</b> Part Number: TB85616 	<b>Shock Mount Nut</b> Part Number: PN 301 	<b>Latch Cover Rivet</b> Part Number: PN 285 	
	<b>Shock Mount</b> Part Number: SL-69 			<b>Latch Rivet</b> Part Number: PN 157 	
				<b>Hinge Rivet</b> Part Number: PN 762 	
<b>Rod Clip</b> Part Number: LCC-1 	<b>Rod Guide</b> Part Number: TB85615 	<b>1/4" Flat Washer</b> Part Number: PN 72B 	<b>1/4 x 1" Sheet Metal Screw</b> Part Number: PN 97B 	<b>1/4 x 1" Sheet Metal Screw</b> Part Number: PN 97 	<b>1/4 x 1" Button Head Screw</b> Part Number: PN 96B 
	<b>1/4" Locknut</b> Part Number: PN 341B 	<b>Mounting Bracket</b> Part Number: TB85616 	<b>Divider Mounting Channel</b> Part Number: TB-Channel 	<b>Toolbox Divider</b> Part Number: TB-Divider 	<b>Toolbox Divider Tape</b> Part Number: CO-tape 
<b>Rear View: Locking Latch</b> Part Number: TB85613 	<b>Rear View: Non-Locking Latch</b> Part Number: TB85614 	<b>Rear View: Locking Hook</b> Part Number: TB85608 	<b>Rear View: Non-Locking Hook</b> Part Number: TB85608 		

### Ordering Replacement Parts:

Ordering replacement parts for your toolbox is fast, convenient, and easy. Just call our customer service phone number at 1-800-779-2102 for pricing and ordering information. Please provide the customer service representative with the part number from the above parts list.